

SECOND EDITION

Integrated Materials and Construction Practices for Concrete Pavement:

A STATE-OF-THE-PRACTICE MANUAL



IOWA STATE UNIVERSITY
Institute for Transportation

National Concrete Pavement
Technology Center



MAY 2019

About the National CP Tech Center

The mission of the National Concrete Pavement Technology (CP Tech) Center at Iowa State University is to unite key transportation stakeholders around the central goal of advancing concrete pavement technology through research, tech transfer, and technology implementation.

Notice

The contents of this guide reflect the views of the authors, who are responsible for the facts and the accuracy of the information presented herein. The opinions, findings and conclusions expressed in this publication are those of the authors and not necessarily those of the sponsors.

The sponsors assume no liability for the contents or use of the information contained in this document. This guide does not constitute a standard, specification, or regulation.

The sponsors do not endorse products or manufacturers. Trademarks or manufacturers' names appear in this guide only because they are considered essential to the objective of the document.

Quality Assurance Statement

The Federal Highway Administration (FHWA) provides high-quality information to serve Government, industry, and the public in a manner that promotes public understanding. Standards and policies are used to ensure and maximize the quality, objectivity, utility, and integrity of its information. The FHWA periodically reviews quality issues and adjusts its programs and processes to ensure continuous quality improvement.

Iowa State University Nondiscrimination Statement

Iowa State University does not discriminate on the basis of race, color, age, ethnicity, religion, national origin, pregnancy, sexual orientation, gender identity, genetic information, sex, marital status, disability, or status as a US Veteran. Inquiries regarding nondiscrimination policies may be directed to Office of Equal Opportunity, 3410 Beardshear Hall, 515 Morrill Road, Ames, Iowa 50011, Tel. 515-294-7612, Hotline: 515-294-1222, email: eooffice@iastate.edu.

Additional Iowa DOT Statements

Federal and state laws prohibit employment and/or public accommodation discrimination on the basis of age, color, creed, disability, gender identity, national origin, pregnancy, race, religion, sex, sexual orientation or veteran's status. If you believe you have been discriminated against, please contact the Iowa Civil Rights Commission at 800-457-4416 or Iowa Department of Transportation's affirmative action officer. If you need accommodations because of a disability to access the Iowa Department of Transportation's services, contact the agency's affirmative action officer at 800-262-0003.

The preparation of this guide was financed in part through funds provided by the Iowa Department of Transportation through its "Second Revised Agreement for the Management of Research Conducted by Iowa State University for the Iowa Department of Transportation" and its amendments.

Front Cover Image Credits

Top: ACPA, used with permission

Bottom Left and Right: Jim Grove, ATI Inc./FHWA, used with permission

Bottom Center: National CP Tech Center

Technical Report Documentation Page

1. Report No. Part of InTrans Project 13-482	2. Government Accession No.	3. Recipient's Catalog No.			
4. Title and Subtitle Integrated Materials and Construction Practices for Concrete Pavement: A State-of-the-Practice Manual		5. Report Date May 2019			
		6. Performing Organization Code			
7. Author(s) Peter Taylor, Tom Van Dam, Larry Sutter, and Gary Fick		8. Performing Organization Report No. Part of InTrans Project 13-482			
9. Performing Organization Name and Address National Concrete Pavement Technology Center Iowa State University 2711 South Loop Drive, Suite 4700 Ames, IA 50010-8664		10. Work Unit No.			
		11. Contract or Grant No. Part of TPF-5(286)			
12. Sponsoring Organization Name and Address <table style="width: 100%; border: none;"> <tr> <td style="width: 50%; border: none; vertical-align: top;"> Federal Highway Administration Transportation Pooled Fund TPF-5(286) 1200 New Jersey Ave., S.E. Washington, DC 20590 </td> <td style="width: 50%; border: none; vertical-align: top;"> Iowa Department of Transportation 800 Lincoln Way Ames, Iowa 50010 </td> </tr> </table>		Federal Highway Administration Transportation Pooled Fund TPF-5(286) 1200 New Jersey Ave., S.E. Washington, DC 20590	Iowa Department of Transportation 800 Lincoln Way Ames, Iowa 50010	13. Type of Report and Period Covered Second Edition Guide	
		Federal Highway Administration Transportation Pooled Fund TPF-5(286) 1200 New Jersey Ave., S.E. Washington, DC 20590	Iowa Department of Transportation 800 Lincoln Way Ames, Iowa 50010		
		14. Sponsoring Agency Code			
15. Supplementary Notes Visit http://www.cptechcenter.org/ for color pdfs of this and other publications from the National CP Tech Center.					
16. Abstract <p>At the heart of all concrete pavement projects is the concrete itself. This manual is intended as both a training tool and a reference to help concrete paving engineers, designers, quality control personnel, contractors, suppliers, technicians, and tradespeople bridge the gap between the most recent research and practice to optimize the performance of concrete for pavements.</p> <p>With the first edition published at the end of 2006, this second edition provides an update and refresh to help users of this guide do the following:</p> <ul style="list-style-type: none"> • Understand concrete pavement construction as a complex, integrated system involving several discrete practices that interrelate and affect one another in various ways • Understand and implement technologies, tests, and best practices to identify materials, concrete properties, and construction practices that are known to optimize concrete performance • Recognize factors that lead to premature distress in concrete and learn how to avoid or reduce those factors • Quickly access how-to and troubleshooting information <p>This second edition includes a new chapter on the Basics of Concrete Pavement Sustainability and a chapter that was merged into one from two chapters in the first edition (Preparation for Concrete Placement and Construction).</p>					
17. Key Words concrete hydration—concrete pavement construction—concrete pavement materials—concrete pavement performance—concrete pavement QA/QC—concrete pavement sustainability—concrete pavement troubleshooting		18. Distribution Statement No restrictions.			
19. Security Classification (of this report) Unclassified	20. Security Classification (of this page) Unclassified	21. No. of Pages 333	22. Price N/A		

Integrated Materials and Construction Practices for Concrete Pavement: A State-of-the-Practice Manual

Second Edition - May 2019

Principal Investigator

Peter Taylor, Director
National Concrete Pavement Technology Center, Iowa State University

Project Manager

Steve Tritsch – National Concrete Pavement Technology Center, Iowa State University

Second Edition Authors

Peter Taylor – National Concrete Pavement Technology Center, Iowa State University

Tom Van Dam – Nichols Consulting Engineers, Chtd.

Larry Sutter – Michigan Technological University

Gary Fick – The Transtec Group, Inc.

Sponsored by

Federal Highway Administration Transportation Pooled Fund TPF-5(286):
Georgia Department of Transportation (DOT), Iowa DOT (lead state), Michigan DOT,
Oklahoma DOT, and Pennsylvania DOT

Preparation of this guide was financed in part through funds provided by the Iowa DOT through its Research Management Agreement with the Institute for Transportation (Part of InTrans Project 13-482)

A guide from

National Concrete Pavement Technology Center

Iowa State University

2711 South Loop Drive, Suite 4700

Ames, IA 50010-8664

Phone: 515-294-5798 / Fax: 515-294-0467

www.cptechcenter.org

Acknowledgments

The project team is grateful to the professionals and members of organizations in the national concrete pavement community who have supported and contributed to this work. They also want to thank the Federal Highway Administration (FHWA) for its continued support and sponsorship.

The first edition of this manual reflected the professional expertise of countless technical experts on the wide variety of discrete processes and variables that must be integrated to optimize the performance of concrete in pavements. These individuals represented the state of the science and art of concrete pavement design, materials, and construction in the US and helped bridge the gap between recent research and common practice.

The following content experts contributed to one or more chapters of the first edition of this manual and deserve special recognition: Michael Ayers, Allen Davis, Gary Fick, John Gajda, Jim Grove, Dale Harrington, Beatrix Kerkhoff, Steve Kosmatka, H. Celik Ozyildirim, James M. Shilstone, Kurt Smith, Scott M. Tarr, Peter C. Taylor, Paul D. Tennis, Thomas J. Van Dam, Gerald Voigt, and Steve Waalkes.

These first edition experts made this second, refreshed edition, which was sponsored by the FHWA Transportation Pooled Fund (TPF) Next Generation Concrete Pavement (CP) Road Map, possible. The project team gratefully acknowledges the support from the following TPF-5(286) state department of transportation (DOT) partners:

- Georgia DOT
- Iowa DOT (lead state)
- Michigan DOT
- Oklahoma DOT
- Pennsylvania DOT

The team also wants to acknowledge the contributions of the project's reviewers of both the first and second editions of this manual who were responsible for the technical direction and updates; their feedback and suggestions were invaluable. These individuals helped develop the revised outline for the second edition and critically reviewed several drafts:

Andy Bennett, Michigan DOT

Lyndi Blackburn, Alabama DOT

Dan DeGraaf, Michigan Concrete Association

Gary DeWitt, Colorado DOT

Angela Folkestad, Colorado/Wyoming American Concrete Pavement Association (ACPA)

Benjamin J. Franklin, Ozinga Cement

Max Grogg, FHWA-Iowa Division, retired

Jim Grove, FHWA

Steve Healow, FHWA-California Division

Allen Johnson, W.R. Grace & Co., retired

Kevin Klein, GOMACO Corporation

Jim Mack, CEMEX USA

David Meggers, Kansas DOT

Kevin Merryman, Iowa DOT

Mehdi Parvini, California DOT

Chris Poe, AJAX Paving

David Suchorski, Ash Grove Cement Company

Shannon Sweitzer, S&ME

Brett Trautman, Missouri DOT

Leif Wathne, ACPA

Tom Yu, FHWA

Finally, but certainly not least, the National Concrete Pavement Technology (CP Tech) Center wants to thank the ACPA and the Portland Cement Association (PCA), in particular, for their support in producing this manual.

One last note: members of the Publications group at the Institute for Transportation, which the National CP Tech Center at Iowa State University is a part of, provided the editorial and production support to make this revised edition of the manual possible. Their efforts are greatly appreciated.

Reference information for this guide

Taylor, P. C., T. J. Van Dam, L. L. Sutter, and G. J. Fick. 2019. *Integrated Materials and Construction Practices for Concrete Pavement: A State-of-the-Practice Manual*. Second Edition. National Concrete Pavement Technology Center, Iowa State University, Ames, IA.

Contents

Acknowledgments.....iv	
Reference information for this guide.....iv	
Chapter 1	
Introduction.....1	
Purpose of This Manual.....2	
Today’s Construction Environment.....2	
Principles of Concrete Pavement as an Integrated System.....3	
Optimizing Concrete for Pavements.....3	
Establishing the Performance Needed.....3	
Delivering Concrete That Performs as Required.....4	
Quality Assurance.....4	
Organization of This Manual.....4	
Chapter 2	
Basics of Concrete Pavement Sustainability..5	
What is Pavement Sustainability?.....6	
Key Points.....6	
Background.....6	
Defining a Sustainable Pavement.....6	
The Pavement Life Cycle.....7	
Assessing Pavement Sustainability.....8	
Consideration of Trade-Offs.....9	
Sustainable Strategies for Concrete Pavement Design.....10	
Key Points.....10	
Surface and Structural Performance10	
Mechanistic-Empirical Design11	
Pavement Design Strategies for Longevity.....12	
Design with Local and Recycled Materials.....13	
Additional Design Strategies and Features That Impact Sustainability.....13	
Surface Texture.....13	
Stormwater Management.....13	
Surface Reflectivity14	
Pavement Aesthetics.....16	
Modular Pavement Systems.....16	
Sustainable Strategies for Selecting and Using Materials in Concrete Pavements.....17	
Key Points.....17	
Background.....17	
Use of Recycled, Coproduct, and Waste Materials.....17	
Cementitious Materials and Concrete Mixtures.....18	
Portland Cement.....18	
Supplementary Cementitious Materials.....18	
Blended Cements.....19	
Aggregate Materials.....19	
Aggregates in Concrete.....19	
Concrete Mixture Proportioning and Production.....20	
Other Concrete Mixtures and Emerging Technologies..20	
Sustainable Strategies for Construction of Concrete Pavements.....21	
Key Points.....21	
Background.....21	
Sustainability of Pavement Construction Operations..21	
Construction-Related Energy Consumption.....21	
Effects on the Surrounding Area.....21	
Economics of Construction Practices.....22	
Impacts of Constructed Characteristics on Pavement Sustainability.....22	
Construction Quality.....22	
Finishing and Texturing.....23	
References.....24	
Chapter 3	
Basics of Concrete Pavement Design.....29	
Integrated Pavement Design.....30	
Key Points.....30	
Mechanistic-Empirical Design32	
Common Concrete Pavement Types.....32	
Jointed Plain Concrete Pavement.....32	
Continuously Reinforced Concrete Pavement.....33	
Thin Concrete Pavement.....33	
Design Considerations: What Do We Want?.....33	
Key Points.....33	
Service Life.....34	
Pavement Performance.....34	
Structural Performance.....34	
Functional Performance.....36	

Concrete Properties.....	37
Concrete Strength.....	37
Elastic Modulus (Stiffness).....	38
Drying Shrinkage and Thermal Expansion/ Contraction.....	38
Durability.....	38
Surface Texture: Balancing Friction and Noise.....	39
Conventional Texturing Techniques	39
Innovative Texturing Techniques.....	41
Design Considerations: What Site Factors Do We Have to Accommodate?.....	41
Key Points.....	41
Subgrade Support.....	41
Environmental Factors.....	42
Truck and Heavy Traffic Considerations.....	42
Design Procedures: Getting What We Want for Given Site Factors.....	42
Key Points.....	42
Mechanistic-Empirical Design Procedure.....	43
MEPDG Input Parameters.....	43
Other Design Tools.....	44
Constructability Issues.....	44
Mix Design.....	45
Pavement Design.....	45
Construction.....	45
Curing and Opening to Traffic.....	45
Maintenance.....	45
Concrete Overlays.....	46
Key Points.....	46
Concrete Overlay Options.....	46
Concrete Overlays on Concrete Pavements.....	47
Concrete Overlays on Asphalt Pavements.....	47
Concrete Overlays on Composite Pavements.....	48
Mechanistic-Empirical Concrete Overlay Thickness Design.....	48
Additional Design Considerations.....	48
References.....	49

Chapter 4

Fundamentals of Materials Used for Concrete Pavements.....	51
Cementitious Materials.....	53
Key Points.....	53
Hydraulic Cement.....	54
Portland Cement.....	54
Blended Cements.....	54
Performance Specifications for Hydraulic Cements...55	
Selecting and Specifying Hydraulic Cements.....55	
Supplementary Cementitious Materials.....	56
Types of Supplementary Cementitious Materials....57	
Effects of Supplementary Cementitious Materials in Concrete.....	60
Aggregates.....	63
Key Points.....	63
Aggregate Types.....	64
Carbonate Rock.....	66
Granite.....	66
Gravel and Sand.....	66
Manufactured Aggregate.....	67
Recycled Aggregate.....	67
Physical Properties of Aggregates.....	68
Aggregate Gradation.....	68
Aggregate Particle Shape.....	71
Aggregate Surface Texture.....	71
Aggregate Absorption.....	71
Aggregate Coefficient of Thermal Expansion.....72	
Aggregate Durability.....	72
Water.....	75
Key Points.....	75
Sources of Water in the Mixture.....	75
Water Quality.....	76
Recycled Water.....	76
Chemical Admixtures.....	78
Key Points.....	78
Air-Entraining Admixtures.....	79
Function of Air Entrainment in Concrete.....79	
Air-Entraining Agent Mechanisms.....	80
Side Effects of Air-Entraining Admixtures.....81	

Water Reducers.....	81	Gypsum.....	102
Function of Water Reducers.....	81	Portland Cement Hydration.....	104
Water-Reducing Agent Mechanisms.....	82	Key Points.....	104
Side Effects of Water Reducers.....	82	Primary Products of Hydration.....	105
Set-Modifying Admixtures.....	82	Silicate (Alite and Belite) Reactions.....	106
Primary Function of Set-Modifying Admixtures....	83	Aluminate and Sulfate Reactions.....	108
Set-Modifying Agent Mechanisms.....	83	Ground Limestone Reactions.....	109
Side Effects of Set-Modifying Admixtures.....	83	Factors Affecting Hydration Rates.....	109
Other Admixtures.....	83	Reactions of Supplementary Cementitious	
Dowel Bars, Tiebars, and Reinforcement.....	84	Materials.....	109
Key Points.....	84	Key Points.....	109
Dowel Bars (Smooth Bars).....	84	Hydraulic Supplementary Cementitious Materials....	110
Tiebars (Deformed Bars).....	84	Pozzolanic Supplementary Cementitious Materials...110	
Reinforcement.....	85	Impact of Hydration.....	112
Materials for Dowel Bars, Tiebars, and Reinforcement..	85	Implications of Cement Hydration for Construction	
Steel.....	85	Practices (Fresh Properties).....	112
Epoxy-Coated Bars.....	86	Stage 1: Mixing.....	112
Stainless Steel Bars.....	86	Stage 2: Dormancy.....	112
Stainless-Clad Bars.....	86	Stage 3: Hardening.....	112
Fiber-Reinforced Polymer.....	86	Stage 4: Cooling.....	112
Synthetic Fibers.....	87	Stage 5: Densification.....	112
Other Materials.....	87	Potential Materials Incompatibilities.....	113
Curing Compounds.....	87	Stage 1: Mixing.....	113
Key Points.....	87	Stage 2: Dormancy.....	113
Types of Curing Compounds.....	88	Stage 3: Hardening.....	113
References.....	89	Stage 4: Cooling.....	113
		Stage 5: Densification.....	113
		Key Points.....	114
		Stiffening and Setting.....	114
		Air-Void System Incompatibilities.....	116
		Testing for and Prevention of Incompatibilities....	117
		Potential Solutions to Incompatibilities.....	118
		Implications of Cement Hydration for Hardened	
		Concrete Properties.....	119
		Stage 1: Mixing.....	119
		Stage 2: Dormancy.....	119
		Stage 3: Hardening.....	119
		Stage 4: Cooling.....	119
		Stage 5: Densification.....	119
		Air-Void System.....	119
		Pores.....	120

Chapter 5

Hydration/Transformation of Concrete from Plastic to Solid..... 95

Introduction..... 96

Stages of Hydration: Overview..... 96

Mixing.....98

Dormancy.....98

Hardening.....99

Cooling.....100

Densification.....100

Portland Cement.....101

Key Points.....101

Portland Cement Compounds.....101

 Portland Cement Clinker.....102

Permeability.....	120	Factors Affecting Uniformity.....	129
Concrete Strength Gain, Tensile Stress, and the Sawing Window.....	120	Workability.....	130
Implications of Cement Hydration for Cracking.....	121	Key Points.....	130
Stage 1: Mixing.....	121	Simple Definition.....	130
Stage 2: Dormancy.....	121	Significance of Workability.....	130
Stage 3: Hardening.....	121	Factors Affecting Workability.....	130
Stage 4: Cooling.....	121	Workability Testing.....	132
Stage 5: Densification.....	121	Segregation of Concrete Materials.....	134
Cracking.....	121	Key Points.....	134
Stages of Hydration: Details.....	122	Simple Definition.....	134
Primary Hydration Products.....	122	Significance of Segregation.....	134
Stages of Hydration.....	122	Factors Affecting Segregation.....	134
Stage 1: Mixing.....	122	Segregation Testing.....	134
Stage 2: Dormancy.....	122	Bleeding.....	135
Stage 3: Hardening.....	123	Key Points.....	135
Stage 4: Cooling.....	123	Simple Definition.....	135
Stage 5: Densification.....	123	Significance of Bleeding.....	135
Effects of Supplementary Cementitious Materials and Ground Limestone.....	124	Factors Affecting Bleeding.....	136
Stage 1: Mixing.....	124	Testing for Bleeding.....	136
Stage 2: Dormancy.....	124	Setting.....	137
Stage 3: Hardening.....	124	Key Points.....	137
Stage 4: Cooling.....	124	Simple Definition.....	137
Stage 5: Densification.....	124	Significance of Setting.....	137
Effects of Chemical Admixtures.....	125	Factors Affecting Setting.....	137
Stage 1: Mixing.....	125	Testing for Setting Time.....	138
Stage 2: Dormancy.....	125	Temperature Effects.....	139
Stage 3: Hardening.....	125	Key Points.....	139
Stage 4: Cooling.....	125	Simple Definition.....	139
Stage 5: Densification.....	125	Significance of Thermal Properties.....	139
References.....	126	Factors Affecting Thermal Properties.....	140
Chapter 6		Testing for Thermal Properties.....	141
Critical Properties of Concrete.....	127	Mechanical Properties.....	142
Introduction.....	128	Strength and Strength Gain.....	142
Fresh Properties.....	128	Key Points.....	142
Uniformity of Mixture.....	128	Simple Definition.....	142
Key Points.....	128	Significance of Strength and Strength Gain.....	142
Simple Definition.....	128	Factors Affecting Strength and Strength Gain.....	143
Significance of Uniformity.....	128	Strength Testing: Mix Design Stage.....	145
		Strength Testing: Field Tests.....	146
		Maturity Testing	146

Modulus of Elasticity and Poisson's Ratio.....	148	Factors Affecting Resistance to Freezing and Thawing.....	170
Key Points.....	148	Testing.....	171
Simple Definition.....	148	Sulfate Resistance.....	174
Significance of Modulus of Elasticity.....	148	Key Points.....	174
Factors Affecting the Modulus of Elasticity.....	149	Simple Definition.....	174
Testing for Modulus of Elasticity and Poisson's Ratio.....	149	Significance of Sulfate Resistance.....	174
Shrinkage.....	149	Factors Affecting Sulfate Attack.....	174
Key Points.....	149	Testing.....	175
Simple Definition	149	Alkali-Silica Reaction.....	175
Significance of Shrinkage.....	149	Key Points.....	175
Factors Affecting Shrinkage.....	150	Simple Definition.....	175
Testing for Shrinkage	151	Significance of Alkali-Silica Reaction.....	176
Abrasion Resistance.....	151	Factors Affecting Alkali-Silica Reaction.....	177
Key Points.....	151	Testing.....	177
Simple Definition.....	151	References.....	179
Significance of Abrasion Resistance.....	151	Chapter 7	
Factors Affecting Abrasion Resistance.....	151	Mixture Design and Proportioning.....	185
Testing.....	152	Introduction.....	186
Early-Age Cracking.....	153	Sequence of Development.....	186
Key Points.....	153	Pre-Construction.....	186
Simple Definition.....	153	Specifications for Mixture Design.....	186
Significance of Early-Age Cracking.....	153	Bidding.....	187
Factors Affecting Early-Age Cracking.....	154	Laboratory Mixtures.....	187
Controlling Early-Age Cracks.....	156	Anticipating Responses to Field Conditions.....	187
Preventing Early-Age Cracks.....	158	Field Trials.....	188
Testing for Cracking Risk.....	159	Aggregate Grading Optimization.....	188
Summary of Preventable Early-Age Cracks.....	160	Tarantula Curve.....	189
Durability Related Properties.....	164	Coarseness Factor Chart	189
Transport (Permeability).....	165	0.45 Power Chart	190
Key Points.....	165	Percent Aggregate Retained (Haystack) Chart	190
Simple Definition.....	165	Calculating Mixture Proportions.....	191
Significance of Permeability.....	165	Key Points.....	191
Factors Affecting Permeability.....	165	The Void Ratio Method.....	191
Testing.....	165	Select an Aggregate System.....	191
Resistance to Freezing and Thawing.....	167	Select a Paste System.....	191
Key Points.....	167	Select the Paste Quantity	192
Simple Definition.....	167		
Significance of Resistance to Freezing and Thawing.....	167		

The Absolute Volume Method.....	192	Improving Soil Characteristics.....	205
Step 1: Concrete Strength.....	192	Trimming.....	205
Step 2: Water/Cementitious Materials Ratio.....	192	Proof-Rolling.....	205
Step 3: Aggregates.....	193	Intelligent Compaction.....	205
Step 4: Air Content.....	193	Bases.....	206
Step 5: Workability/Slump.....	194	Key Points.....	206
Step 6: Water Content.....	194	Types of Bases.....	206
Step 7: Cementitious Materials Content.....	194	Unstabilized (Granular) Bases.....	206
Step 8: Cementitious Materials Type.....	194	Stabilized (Treated) Bases.....	206
Step 9: Admixtures.....	195	Grading Control.....	207
Step 10: Fine Aggregate.....	195	Compaction Requirements for Dense Graded Bases..	207
Step 11: Moisture/Absorption Correction.....	195	Compaction Requirements for Permeable Bases.....	207
Step 12: Trial Batches.....	195	Materials.....	207
Adjusting Properties.....	196	Construction.....	207
Key Points.....	196	Drainage in the Base Layer.....	208
Workability.....	196	Trackline.....	208
Stiffening and Setting.....	196	Trimming to Grade.....	209
Bleeding.....	197	Concrete Paving.....	209
Air-Void System.....	197	Field Verification of the Concrete Mixture.....	209
Density (Unit Weight).....	198	Key Points.....	209
Strength.....	198	Concrete Production.....	209
Volume Stability.....	199	Key Points.....	209
Permeability and Frost Resistance.....	199	Setting Up the Plant.....	210
Abrasion Resistance.....	199	Handling Materials.....	211
Sulfate Resistance.....	199	Stockpile Management.....	211
Alkali-Silica Reaction.....	199	Batching.....	212
References.....	200	Mixing Concrete.....	213
 		Delivering Concrete.....	213
Chapter 8		Field Adjustments.....	214
Construction.....	201	Paving.....	216
Introduction.....	202	Key Points.....	216
Subgrades.....	202	Placement (Fixed Form).....	217
Key Points.....	202	Consolidation (Fixed Form).....	217
Uniform Support.....	203	Placement (Slipform).....	217
Expansive Soils.....	203	Consolidation (Slipform).....	218
Frost Action.....	204	Horizontal and Vertical Control of the Paver.....	219
Pumping.....	204	Edge Slump.....	221
Grading and Compaction.....	204	Dowel Bars and Tiebars.....	222
Pre-Grading.....	205		
Moisture-Density Control.....	205		

Finishing.....	224	Dowel Bar Tolerances.....	252
Key Points.....	224	Alignment (Tilt and Skew).....	253
Texturing	225	Embedment Length (Longitudinal Translation).....	253
Pavement Smoothness.....	226	Horizontal Translation.....	253
Curing.....	228	Dowel Depth (Vertical Translation).....	254
Key Points.....	228	Thickness.....	254
Curing Compounds.....	228	Real-Time Smoothness.....	254
Other Curing Methods.....	229	Test Methods.....	254
Weather.....	230	Combined Grading.....	255
Key Points.....	230	Purpose—Why Do This Test?.....	255
Hot-Weather Concreting.....	230	Principle—What Is the Theory?.....	255
Cold-Weather Placement.....	232	Test Procedure—How Is the Test Run?.....	255
Early- and Late-Season Placements.....	233	Output—How Do I Interpret the Results?.....	255
Protection from Rain.....	233	Construction Issues—What Should I Look For?..	255
Crack Prediction with HIPERPAV.....	234	VKkelly (Response to Vibration).....	255
Joint Sawing.....	235	Purpose—Why Do This Test?.....	255
Key Points.....	235	Principle—What Is the Theory?.....	255
Saw Timing.....	236	Test Procedure—How Is the Test Run?.....	255
Mixture Effects.....	238	Test Apparatus	256
Joint Sealing.....	238	Summary of Test Method	256
Key Points.....	238	Output—How Do I Interpret the Results?.....	256
References.....	241	Construction Issues—What Should I Look For?..	256
 		Box Test (Response to Vibration).....	256
Chapter 9		Purpose—Why Do This Test?.....	256
Quality and Testing.....	243	Principle—What Is the Theory?.....	256
Quality Assurance.....	244	Test Procedure—How Is the Test Run?.....	257
Acceptance.....	244	Test Apparatus.....	257
Quality Control.....	245	Summary of Test Method (Figure 9-4).....	257
Quality of Testing.....	245	Output—How Do I Interpret the Results?.....	258
Record Keeping.....	246	Construction Issues—What Should I Look For?..	258
Monitoring the Mixture.....	247	Foam Drainage.....	258
Batching.....	250	Purpose—Why Do This Test?.....	258
Air Content.....	250	Principle—What Is the Theory?.....	258
Aggregate Moisture.....	250	Test Procedure—How Is the Test Run?.....	258
Water/Cementitious Materials Ratio	250	Test Apparatus.....	258
Batching Tolerances.....	251	Output—How Do I Interpret the Results?.....	258
Monitoring Construction Activities.....	251		
Key Points.....	251		
Temperature.....	252		
Vibration Monitoring.....	252		

Air Content (Plastic Concrete, Pressure Method).....	259	Concrete Maturity.....	263
Purpose—Why Do This Test?.....	259	Purpose—Why Do This Test?.....	263
Principle—What Is the Theory?.....	259	Principle—What Is the Theory?.....	263
Summary of Test Procedure—How Is the Test Run?.....	259	Test Procedure—How Is the Test Run?.....	263
Test Apparatus.....	259	Test Apparatus.....	263
Test Method.....	259	Summary of Test Method.....	264
Output—How Do I Interpret the Results?.....	259	Output—How Do I Interpret the Results?.....	264
Construction Issues—What Should I Look For?..	259	Construction Issues—What Should I Look For?..	264
Super Air Meter.....	259	Resistivity/Formation Factor.....	264
Purpose—Why Do This Test?.....	259	Purpose—Why Do This Test?.....	264
Principle—What Is the Theory?.....	259	Principle—What Is the Theory?.....	264
Summary of Test Procedure—How Is the Test Run?.....	260	Test Procedure—How Is the Test Run?.....	264
Test Apparatus	260	Test Apparatus	265
Test Method.....	260	Output—How Do I Interpret the Results?.....	265
Output—How Do I Interpret the Results?.....	260	Construction Issues—What Should I Look For?..	265
Construction Issues—What Should I Look For?..	260	Sorption.....	265
Air Content (Hardened Concrete).....	260	Purpose—Why Do This Test?.....	265
Purpose—Why Do This Test?.....	260	Principle—What Is the Theory?.....	265
Principle—What Is the Theory?.....	260	Test Procedure—How Is the Test Run?.....	265
Test Procedure—How Is the Test Run?.....	260	Test Apparatus.....	265
Test Apparatus	261	Output—How Do I Interpret the Results?.....	265
Output—How Do I Interpret the Results?.....	261	Construction Issues—What Should I Look For?..	266
Construction Issues—What Should I Look For?..	261	Water/Cementitious Materials Ratio (Microwave)....	266
Unit Weight.....	261	Purpose—Why Do This Test?.....	266
Purpose—Why Do This Test?.....	261	Principle—What Is the Theory?.....	266
Principle—What Is the Theory?.....	261	Test Procedure—How Is the Test Run?.....	266
Test Procedure—How Is the Test Run?.....	262	Test Apparatus.....	266
Test Apparatus.....	262	Output—How Do I Interpret the Results?.....	266
Output—How Do I Interpret the Results?.....	262	Construction Issues—What Should I Look For?..	266
Construction Issues—What Should I Look For?..	262	Semi-Adiabatic Calorimetry.....	266
Flexural Strength and Compressive Strength (Seven Day).....	262	Purpose—Why Do This Test?.....	266
Purpose—Why Do this Test?.....	262	Principle—What Is the Theory?.....	266
Principle—What Is the Theory?.....	262	Test Procedure—How Is the Test Run?.....	267
Test Procedure—How Is the Test Run?.....	262	Test Apparatus.....	267
Test Apparatus	262	Output—How Do I Interpret the Results?.....	267
Summary of Test Method.....	262	Construction Issues—What Should I Look For?..	267
Output—How Do I Interpret the Results?.....	263		
Construction Issues—What Should I Look For?..	263		

Concrete Temperature, Subgrade Temperature, and Project Environmental Conditions.....	267
Purpose—Why Do This Test?.....	267
Principle—What Is the Theory?.....	267
Test Procedure—How Is the Test Run?.....	267
Test Apparatus.....	267
Output—How Do I Interpret the Results?.....	267
Construction Issues—What Should I Look For?..	268
Coefficient of Thermal Expansion.....	268
Purpose—Why Do This Test?.....	268
Principle—What Is the Theory?.....	268
Test Procedure—How Is the Test Run?.....	268
Test Apparatus.....	268
Output—How Do I Interpret the Results?.....	268
Construction Issues—What Should I Look For?..	268
Pavement Thickness.....	268
Purpose—Why Do This Test?.....	268
Principle—What Is the Theory?.....	268
Test Procedure—How Is the Test Run?.....	268
Output—How Do I Interpret the Results?.....	269
Construction Issues—What Should I Look For?..	269
Dowel Bar Alignment.....	269
Purpose—Why Do This Test?.....	269
Principle—What Is the Theory?.....	269
Test Procedure—How Is the Test Run?.....	269
Output—How Do I Interpret the Results?.....	269
Construction Issues—What Should I Look For?..	269
Smoothness.....	269
Purpose—Why Do This Test?.....	269
Principle—What Is the Theory?.....	269
Test Procedure—How Is the Test Run?.....	269
Test Apparatus.....	269
Test Method.....	270
Output—How Do I Interpret the Results?.....	270
Construction Issues—What Should I Look For?..	271
References.....	272

Chapter 10	
Troubleshooting and Prevention.....	275
Overview.....	276
Before the Concrete Has Set.....	276
After the Concrete Has Set.....	284
In the First Days after Placing.....	284
Some Time after Construction.....	289
References.....	293
Glossary.....	295

Figures

Chapter 2

Figure 2-1. Pavement life-cycle phases.....	8
Figure 2-2. Examples of fully permeable concrete pavement systems.....	14
Figure 2-3. Heat islands for various areas of development.....	14
Figure 2-4. Using color and patterns in concrete to identify pedestrian crosswalk.....	16
Figure 2-5. Concrete pavement and permeable interlocking concrete pavers in Milwaukee, Wisconsin...16	

Chapter 3

Figure 3-1. Design features of JPCP.....	31
Figure 3-2. Design features of CRCP.....	31
Figure 3-3. Concrete pavement types.....	32
Figure 3-4. Pavement condition as a function of time or traffic.....	34
Figure 3-5. Corner cracking in jointed concrete pavement.....	35
Figure 3-6. Structural transverse crack.....	35
Figure 3-7. Structural longitudinal crack.....	35
Figure 3-8. Shattered slab.....	36
Figure 3-9. Faulting.....	37
Figure 3-10. Comparison of compressive and flexural strength correlations, based on equations 3.1 and 3.2...38	
Figure 3-11. Next-generation concrete surface (NGCS).....	40
Figure 3-12. Examples of bonded overlays.....	46
Figure 3-13. Examples of unbonded overlays.....	46

Chapter 4

Figure 4-1. Concrete is basically a mixture of cement, water/air, and aggregates (percentages are by volume for pavements).....	52
Figure 4-2. Scanning electron micrograph of fly ash particles.....	58
Figure 4-3. Typical size distributions of cementitious materials.....	58
Figure 4-4. Scanning electron micrograph of slag cement particles.....	59
Figure 4-5. Effects of supplementary cementitious materials on fresh concrete properties.....	61

Figure 4-6. Effects of supplementary cementitious materials on hardened concrete properties.....	61
Figure 4-7. Family of carbonate minerals showing rock and mineral names.....	66
Figure 4-8. Aggregates produced by crushing operation (top) have a rougher surface texture and are angular compared to round river gravel (bottom).....	67
Figure 4-9. Well-graded aggregate with a balanced variety of sizes allows smaller particles to fill voids between larger particles, maximizing aggregate volume.....	69
Figure 4-10. Example of a smooth grading curve that would be preferred.....	71
Figure 4-11. Moisture conditions of aggregates.....	72
Figure 4-12. Aggregate particle that has cracked due to alkali-silica reaction.....	73
Figure 4-13. D-cracking.....	74
Figure 4-14. Popout at the concrete surface.....	74
Figure 4-15. Effect of compressive strength and aggregate type on the abrasion resistance of concrete using ASTM C1138.....	75
Figure 4-16. Recycled water and reclaimed aggregate at a ready-mixed concrete plant.....	77
Figure 4-17. Effect of recycled water on concrete properties.....	78
Figure 4-18. Entrained air bubbles in concrete	79
Figure 4-19. Spacing factor is the average distance from any point to the nearest air void.....	80
Figure 4-20. Stabilization of air voids by air-entraining admixture molecules.....	80
Figure 4-21. Effects of materials and practices on air entrainment.....	81
Figure 4-22. One mechanism by which water reducers work is dispersion: charged cement particles cling together, trapping water (left) and water reducers separate cement grains, releasing the water and making it available for hydration (right).....	82
Figure 4-23. Curing compounds keep concrete partially saturated near the surface during the curing period....	87

Chapter 5

Figure 5-1. Compounds in cement.....	97
Figure 5-2. Concrete characteristics, and implications for workers, during stages of hydration.....	97

Figure 5-3. A gel-like substance coats cement compounds, controlling the reactions and heat.....	98	Figure 5-26. Effect of pozzolans on cement hydration..	110
Figure 5-4. A very brief heat spike occurs during mixing.....	98	Figure 5-27. Early cement reactions are a balance of C_3A and $C\bar{S}$ in solution where excess of either will cause unexpected setting.....	115
Figure 5-5. The concrete does not generate heat during the dormancy stage.....	98	Figure 5-28. Plot of heat generated by cement hydration of cement pastes containing varying amounts of lignosulfonate-based water-reducing admixture.....	116
Figure 5-6. During dormancy, the water becomes saturated with dissolved ions.....	98	Figure 5-29. A typical example of air voids clustered around an aggregate particle.....	116
Figure 5-7. Significant heat is generated during the hardening stage	99	Figure 5-30. A set of field calorimetry data with three different cements and the same dosage of water-reducing admixture, including one set showing clear retardation and low heat output consistent with delayed setting and slow strength gain.....	118
Figure 5-8. Hydration products grow.....	99		
Figure 5-9. Heat energy peaks and then drops during cooling.....	100		
Figure 5-10. Hydration products grow during cooling.....	100		
Figure 5-11. Very little heat is generated during the final, densification stage.....	100		
Figure 5-12. Hydration products mesh into a dense solid.....	100		
Figure 5-13. Composition of portland cement.....	102		
Figure 5-14. Sample mill certificate (ASTM C150-04).....	103		
Figure 5-15. Estimates of the relative volumes of cement compounds and products of hydration with increasing hydration.....	106		
Figure 5-16. Dissolving cement results in calcium ions in solution.....	106		
Figure 5-17. C-S-H and CH begin to form.....	106		
Figure 5-18. C_3S reactions form C-S-H and CH.....	107		
Figure 5-19. Hydration products accumulate and mesh.....	107		
Figure 5-20. C_2S reactions begin contributing to strength gain later.....	107		
Figure 5-21. C-S-H and CH mesh into a solid mass....	108		
Figure 5-22. Reactions of C_3A and $C\bar{S}$ in solution, are responsible for an early heat spike during cement hydration.....	108		
Figure 5-23. Gel-like C-A- \bar{S} -H limits water's access to cement particles.....	108		
Figure 5-24. After $C\bar{S}$ is consumed, remaining C_3A reacts with ettringite.....	109		
Figure 5-25. Ternary diagram illustrating the basic chemical composition of various SCMs compared to portland cement.....	109		
		Chapter 6	
		Figure 6-1. Effect of aggregate gradation on workability as a function of paste content.....	131
		Figure 6-2. VKelly index is the slope of the plot of penetration depth versus root time.....	133
		Figure 6-3. Box test sample after the forms are removed	133
		Figure 6-4. Segregated concrete example.....	134
		Figure 6-5. Bleeding.....	135
		Figure 6-6. Plot of penetration resistance over time to determine setting time.....	138
		Figure 6-7. Ultrasonic velocity accelerates when mixture begins to set.....	138
		Figure 6-8. A typical field semi-adiabatic temperature monitoring system for mortar.....	141
		Figure 6-9. Measuring the coefficient of thermal expansion.....	142
		Figure 6-10. Loads on a pavement induce flexural stresses in the concrete slab.....	143
		Figure 6-11. Cementitious systems that produce high early strengths tend to have lower strengths in the long term when compared to slower hydrating systems....	144
		Figure 6-12. In third-point loading, the entire middle one-third of the beam is stressed uniformly, and thus the beam fails at its weakest point in the middle one-third of the beam.....	145
		Figure 6-13. Splitting tensile strength.....	146
		Figure 6-14. Maturity of the field concrete is equivalent to maturity of the laboratory concrete when the area under the curves is the same.....	147

Figure 6-15. Generalized stress-strain curve for concrete.....	149
Figure 6-16. Total shrinkage is a sum of all individual shrinkage mechanisms. Minimizing any or all of the mechanisms will reduce the risk of cracking.....	150
Figure 6-17. Relationship between total water content and drying shrinkage.....	150
Figure 6-18. Rotating cutter with dressing wheels for the ASTM C944 abrasion resistance test.....	152
Figure 6-19. Cracks generally don't develop in concrete that is free to shrink (top), but slabs on the ground (in reality) are restrained by the subbase or other elements, creating tensile stresses and cracks (bottom).....	154
Figure 6-20. Curling and warping of slabs.....	155
Figure 6-21. Exaggerated illustration of pavement curling: the edge of the slab at a joint or a free end lifts off the base, creating a cantilevered section of concrete that can break off under heavy wheel loading.....	155
Figure 6-22. An eroded base can lead to high tensile stresses, resulting in cracking.....	156
Figure 6-23. A saw cut that has cracked through as planned.....	156
Figure 6-24. This joint was cut too late, resulting in random transverse cracking.....	157
Figure 6-25. Gauged invar rings for casting concrete to monitor both expansion and shrinkage stresses.....	159
Figure 6-26. Plastic shrinkage cracks.....	160
Figure 6-27. Map cracking.....	161
Figure 6-28. Random transverse crack.....	162
Figure 6-29. Random longitudinal crack.....	163
Figure 6-30. Corner break.....	164
Figure 6-31. Wenner resistivity test.....	166
Figure 6-32. Illustration of initial and secondary absorption.....	166
Figure 6-33. Joint damage showing flakes.....	167
Figure 6-34. Joint damage.....	168
Figure 6-35. Scaling.....	169
Figure 6-36. D-cracking.....	169
Figure 6-37. Correlation between SAM number and freeze-thaw performance.....	172
Figure 6-38. Sulfate attack is a chemical reaction between sulfates and the C_3A in cement, resulting in surface softening.....	174
Figure 6-39. Alkali-silica reaction is an expansive reaction of reactive aggregates, alkali hydroxides, and water that may cause cracking in concrete	176
Figure 6-40. ASR protocol	178

Chapter 7

Figure 7-1. Example w/c ratio vs. strength curve.....	188
Figure 7-2. Sample combined gradation (solid center line) inside the Tarantula envelope (outer dotted lines).....	189
Figure 7-3. Modified coarseness factor chart.....	189
Figure 7-4. Sample Power 45 plot.....	190
Figure 7-5. Sample Haystack plot.....	190
Figure 7-6. Bulk volume of coarse aggregate per unit volume of concrete.....	193
Figure 7-7. Target total air content requirements for concretes using different sizes of aggregate.....	193
Figure 7-8. Approximate water requirement for various slumps and crushed aggregate sizes for air-entrained concrete.....	194

Chapter 8

Figure 8-1. Effects of two examples of nonuniform support on concrete slabs on the ground.....	203
Figure 8-2. Relationship between frost action and hydraulic properties of soils.....	204
Figure 8-3. Autograder trims subgrade material.....	205
Figure 8-4. High-density paver placing cement-treated base (CTB).....	207
Figure 8-5. Trackline of slipform paving machine.....	208
Figure 8-6. Portable concrete plant.....	210
Figure 8-7. Loader operation is key to stockpile management.....	211
Figure 8-8. Typical sequence of adding material in a stationary mix plant.....	212
Figure 8-9. Typical sequence of adding material in a truck mixer.....	212
Figure 8-10. Depositing concrete in front of the paving machine.....	214
Figure 8-11. A belt placer/spreader ensures a consistent amount of concrete in front of the paver.....	214
Figure 8-12. A roller screed (single-tube finisher) can be used to strike off the concrete in fixed-form placements.....	217
Figure 8-13. Components of a typical slipform paving machine.....	218
Figure 8-14. An array of vibrators under a slipform paver.....	218
Figure 8-15. Typical string line setup.....	219
Figure 8-16. Conceptual illustration of stringless paving	221
Figure 8-17. Two types of edge slump.....	221

Figure 8-18. Adjustment of the paving mold allows for edge slump.....	221
Figure 8-19. Staking or pinning dowel bar cages.....	222
Figure 8-20. Dowel basket marked with paint for the saw crew (left) and an inserted dowel marked with a nail and washer (right)	223
Figure 8-21. Left, middle, and right: Side-bar inserter, center-bar inserter, and dowel-bar inserter.....	224
Figure 8-22. Next-generation concrete surface (NGCS).....	225
Figure 8-23. Noise and skid resistance are independent.....	225
Figure 8-24. Distribution of noise levels from various texturing methods.....	225
Figure 8-25. Lightweight inertial profiler.....	227
Figure 8-26. Real-time smoothness device mounted to the back of a paver.....	227
Figure 8-27. Curing machine coats both the top surface and sides of a slipform paving slab.....	229
Figure 8-28. A monograph to estimate the rate of evaporation.....	231
Figure 8-29. Plastic sheeting ready for placement to protect the fresh surface from rain.....	233
Figure 8-30. Typical scaling of concrete pavement due to rain on nondurable paste surface.....	233
Figure 8-31. Edge erosion of freshly placed slab due to rain.....	234
Figure 8-32. An example plot reported by HIPERPAV showing a high risk of cracking at about six hours after paving.....	235
Figure 8-33. Common sawing equipment.....	236
Figure 8-34. Sawing window.....	236
Figure 8-35. Close-up of different degrees of raveling caused by joint sawing.....	237
Figure 8-36. Different forms of joint sealant.....	240

Chapter 9

Figure 9-1. Sample control chart: concrete unit weight.....	247
Figure 9-2. Dual-threshold dowel positioning specification concept.....	253
Figure 9-3. VKelly apparatus.....	256
Figure 9-4. Box test procedure.....	257
Figure 9-5. Rating standards for Box test.....	258
Figure 9-6. Super air meter.....	260
Figure 9-7. Plot of SAM number versus spacing factor.....	261
Figure 9-8. Sample maturity curve.....	264
Figure 9-9. Surface resistivity gauge.....	265
Figure 9-10. Heat signature sample plots.....	267
Figure 9-11. High-speed inertial profiler.....	269
Figure 9-12. Raw profile data.....	270
Figure 9-13. ProVAL roughness report.....	270
Figure 9-14. ProVAL power spectral density plot showing a repeating wavelength at 15 ft that corresponds to joint spacing.....	270
Figure 9-15. Real-time smoothness devices: Gomaco GSI (left) and Ames Engineering RTP (right).....	271

Chapter 10

Figure 10-1. Early-age cracking.....	276
--------------------------------------	-----

Tables

Chapter 4

Table 4-1. Portland cement classifications (ASTM C150/C150M and AASHTO M 85)*.....	54
Table 4-2. Blended cement classifications (ASTM C595/C595M and AASHTO M 240).....	55
Table 4-3. Performance classifications of hydraulic cement (ASTM C1157/C1157M).....	55
Table 4-4. Cement types for common applications*....	56
Table 4-5. Specifications for supplementary cementitious materials.....	57
Table 4-6. Chemical analyses and selected properties of Type I cement and several supplementary cementitious materials.....	57
Table 4-7. Mineral constituents in aggregates.....	65
Table 4-8. Rock constituents in aggregates*.....	65
Table 4-9. Summary of mixture properties that may be affected when using RCA and potential consideration for mitigating the changes in mixture properties.....	68
Table 4-10. Typical CTE values for some aggregates ..	72
Table 4-11. Mineral constituents of aggregate that are potentially alkali-reactive.....	73
Table 4-12. Rock types potentially susceptible to alkali-silica reactivity.....	73
Table 4-13. Acceptance criteria for combined mixing water.....	76
Table 4-14. Optional chemical limits for combined mixing water.....	77
Table 4-15. Common chemical admixture types for paving applications.....	79
Table 4-16. Admixture types defined by ASTM C494/AASHTO M 194.....	79
Table 4-17. Tiebar dimensions and spacings.....	85

Chapter 5

Table 5-1. Major compounds in portland cement	101
Table 5-2. Forms of calcium sulfate	102
Table 5-3. Primary products of cement hydration.....	105
Table 5-4. Comparison of C ₃ S and C ₂ S reactions.....	111
Table 5-5. Recommended tests and their applications. .	117

Chapter 6

Table 6-1. Requirements for uniformity of concrete....	129
Table 6-2. Chemical composition and heat evolution of typical portland cements.....	140

Table 6-3. Factors affecting compressive and flexural strength.....	143
---	-----

Table 6-4. Relationship between AASHTO T 277 (ASTM C1202) results, resistivity, and the F-factor, assuming a pore solution resistivity of 0.1 Ω × m.....	166
--	-----

Chapter 8

Table 8-1. Soil index properties and their relationships to potential for expansion.....	203
Table 8-2. Alternatives for reducing friction or bond between concrete pavement and stabilized base materials.....	208
Table 8-3. Concrete plant checklist.....	210
Table 8-4. Various concrete pavement texture options.....	226
Table 8-5. Specification factors that influence pavement smoothness.....	226
Table 8-6. Construction factors that influence pavement smoothness.....	227
Table 8-7. Factors that shorten the sawing window.....	237
Table 8-8. Potential joint performance based on sealing option.....	239

Chapter 9

Table 9-1. Examples of testing precision.....	246
Table 9-2. Sample concrete unit weight test results....	246
Table 9-3. Recommended laboratory tests during prequalification of a mixture.....	248
Table 9-4. Field setup tests.....	249
Table 9-5. Mixture QC tests.....	249
Table 9-6. Mixture acceptance tests.....	249
Table 9-7. Recommended batch tolerances for ready-mixed concrete* (ASTM C94).....	251
Table 9-8. Construction QC tests.....	251
Table 9-9. Construction acceptance tests	251

Chapter 10

Table 10-1. Problems observed before the concrete has set.....	277
Table 10-2. Problems observed in the first days after placing	284
Table 10-3. Preventing problems that are observed some time after construction	289
Table 10-4. Assessing the extent of damage in hardened concrete.....	293

Chapter 1

Introduction

Purpose of This Manual	2
Today's Construction Environment	2
Principles of Concrete Pavement as an Integrated System	3
Optimizing Concrete for Pavements	3
Organization of This Manual	4

Purpose of This Manual

The purpose of this manual is to bridge the gap between recent research and common practice related to producing concrete for pavements. The first edition, published in 2006, had a significant impact on providing practitioners with the tools to design, build, and maintain concrete pavements using the best technologies available at the time.

This edition builds on that success by updating and refreshing the information available to include the growth and innovations that have been implemented into practice in the last 13 years. A chapter on sustainability has been added and the chapters on foundations and construction have been combined. All other chapters follow a similar outline to that used before.

A significant change has been the development of test methods that evaluate the concrete mixture and the new pavement for the properties that govern performance. A new guide specification that uses these methods is also discussed. Tools and approaches are provided that help users design and deliver mixtures that are able to resist the environments they are exposed to, including new aggressive deicing salts. Innovations such as stringless guidance and real-time smoothness (RTS) monitoring are described to assist contractors to reliably produce smooth, long-lasting pavements.

The intended audience is agency or industry personnel who are interested in optimizing concrete performance for every paving project. Users of this manual may include the following:

- Engineers
- Quality control (QC) personnel
- Specifiers
- Contractors
- Materials and equipment suppliers
- Technicians
- Construction supervisors
- Tradespeople

Specifically, this manual will help readers do the following:

- Understand concrete pavements as complex, integrated systems.
- Appreciate that constructing a concrete pavement project is a process involving several discrete practices. These practices interrelate and affect one another in various ways.

- Implement technologies, tests, and best practices to identify materials, concrete properties, and construction practices that are known to optimize concrete performance.
- Recognize factors leading to premature distress in concrete, and learn how to avoid or reduce those factors.
- Quickly access how-to and troubleshooting information.

Today's Construction Environment

In the early days of road building, a civil engineer would work on all aspects of a project. This included securing right-of-way, designing the road and selecting materials, and acting as the resident engineer to help the contractor build the project. The engineer knew everything about the project, and this centralized knowledge facilitated project quality.

As the pavement industry has grown and changed, processes previously handled by a single engineer have been split into separate specialties or departments. This is at least partly because the various processes have become more complex. More ingredients (like supplementary cementitious materials [SCMs] and chemical admixtures) have been introduced to the concrete mix. New testing procedures have been developed. Equipment and placement techniques have changed.

In today's complex road-building environment, dividing responsibilities among departments is effective only as long as communication is effective. Too often, however, this is not the case. The materials engineer focuses on materials, the design engineer focuses on design details, the contractor focuses on construction, and rarely do the parties think about or communicate with each other about the effects of their activities on other parties involved in the process.

For example, engineers trying to advance a new design or solve a specific problem may overlook the concrete materials and focus on other pavement details. Likewise, contractors sometimes try to overcome constructability issues associated with a poor concrete mixture by overusing their equipment rather than seeking to correct the mixture.

It is probably impossible to go back to the days when one engineer handled a concrete paving project from beginning to end. Therefore, as the number of variables and specialties continues to increase, all personnel involved in every stage of a project need to understand how their decisions and activities affect, and are affected by, every other stage of the project.

In other words, today's road-building process must be integrated to be cost-effective and reliable.

Principles of Concrete Pavement as an Integrated System

At the heart of all concrete pavement projects is the concrete itself. The concrete affects, and is affected by, every aspect of the project from design through construction. For this reason, there is a need for pavement to be treated as an integrated system, not just a series of independent activities and materials. Every person involved in the project has to understand the impact of their work on the finished product and what actions or changes are appropriate.

The concrete material itself is only one component of a specific pavement system or project. Other components include the following:

- The foundation system that supports the pavement is a major key to long-term performance of pavements. Long-term stiffness, uniformity, and drainability of the foundation have to be provided in order to prevent movements that lead to failure from cracking, faulting, settlement, and heaving.
- Design details of the foundation, pavement, and mixture systems have to be integrated. For example, mechanistic-empirical (ME) design methodologies can lead to more efficient and sustainable pavements, but some assumptions made during the design (such as coefficient of thermal expansion [CTE]) have to be verified when the final mixture is selected.
- Selection of and changes in raw materials, or their proportions in the mixture, can affect the early and long-term performance of the concrete pavement. At the same time, the inherent variability in raw materials and, indeed, the weather means that adjustments may have to be made on the fly to ensure that a uniform product is delivered in every truck.
- Mixture design is the action of selecting the specified properties of the concrete mixture; whereas, mixture proportioning is the action of selecting the materials and their amounts to achieve those requirements.

Adjustments to the materials selected or their proportions to achieve one parameter may have a negative effect on other parameters.

- Construction of the concrete pavement is a controlled manufacturing process. Variability of the concrete production process must be minimized to produce concrete of consistent quality. For example, a mixture that does not have the workability appropriate for the machine in use is likely to be less durable than intended. Even a perfect mixture can be rendered less than satisfactory if too much water is added or excessive finishing is applied.
- It is insufficient to depend on simple tests to accept or reject a concrete pavement. It is essential to monitor the process, the materials, the mixture, and the workmanship throughout the construction activities. Fast, cost-effective, yet relevant tests are needed to assist with that monitoring.

Optimizing Concrete for Pavements

Optimizing the performance of concrete for pavements involves understanding the variables that affect concrete performance and the properties of concrete that correspond to performance.

Establishing the Performance Needed

The requirements for a given pavement will vary significantly depending on the weather it is exposed to, the traffic, and the required lifetime. Structural design procedures address the latter factors but are silent about the environmental exposures.

The mixture has to be both constructible and durable, and increasing attention is being paid to the need to be sustainable and repairable. Another factor to be accommodated is that the quality of aggregates varies from locality to locality, so rules of thumb for a given city will likely be incorrect elsewhere. A Federal Highway Administration (FHWA) expert task group met over several years and developed the properties that define the likely performance of a mixture:

- Transport—The ability to resist penetration by fluids.
- Cold weather—The ability to resist effects of freezing and thawing as well as the deicing chemicals applied (where necessary).
- Aggregate stability—The tendency for some aggregates to undergo alkali aggregate reaction or d-cracking.
- Shrinkage—The tendency to lead to random cracking or warping of the slabs, particularly in drier regions.

- Strength—The ability to carry the mechanical loads.
- Workability—While this is primarily a concern for the contractor, experience has shown that mixtures placed with the wrong workability are more likely to be short lived.

The American Association of State Highway and Transportation Officials (AASHTO) standard practice PP 84 provides guidance on how these parameters can be specified.

Delivering Concrete That Performs as Required

The growth in use of SCMs and the changing composition of chemical admixtures has made it difficult to ensure performance using a recipe-based approach. Mixtures need to be proportioned using the materials available locally to achieve the needed performance while remaining cost-effective and as sustainable as possible.

Sometimes, the demands on a mixture may be mutually exclusive, e.g., low permeability is best achieved using low water/cementitious materials (w/cm) ratio values, which may also lead to increasing shrinkage and cracking risk. The art of engineering a well-proportioned mixture is in balancing these requirements.

Guidance is provided about selecting materials and proportioning them to meet the needs of the project in hand. This guidance is based on improving the reader’s understanding about what concrete is and how its ingredients affect its properties.

Quality Assurance

A mixture that may appear satisfactory in the laboratory also has to be batched, mixed, delivered, placed, finished, and cured, and the owner has to be provided the data to demonstrate that all of these tasks have been completed in accordance with the specification. Effective tests are needed to provide the data, and guidance is needed to help practitioners make adjustments when things change. The guidance in this manual seeks to provide the reader with the fundamental knowledge to make wise decisions so that long-lasting pavements are delivered every time.

Organization of This Manual

The manual is organized into 10 chapters. Each chapter and section begins with general information and then becomes more detailed.

The emphasis throughout the manual is on concrete as a material and how its quality is affected by all aspects of a pavement project. Topics covered in [Chapters 4 \(Materials\)](#), [5 \(Hydration\)](#), [6 \(Properties\)](#), [7 \(Mixture\)](#), [8 \(Construction\)](#), and [9 \(Quality/Testing\)](#) are central to this emphasis and are more detailed than the others.

Understanding cement hydration ([Chapter 5](#)) is central to successfully integrating the various stages of concrete pavement projects for optimum concrete performance. The charts provide a quick reference to help readers understand the relationships among cement chemistry, stages of hydration, implications of hydration for the construction process, and effects on hydration when SCMs and mineral admixtures are included in the mixture. In addition, the charts highlight some materials incompatibility issues that can arise.

A full-size Stages of Hydration poster is available on request from the National Concrete Pavement Technology (CP Tech) Center (contact information is included at the bottom of the title page and on the outside back cover).

Complete coverage of the topics in the remaining chapters is beyond the scope of this manual, but references are provided to help users access additional information as needed.

Chapter 2

Basics of Concrete Pavement Sustainability

What is Pavement Sustainability?	6
Sustainable Strategies for Concrete Pavement Design	10
Sustainable Strategies for Selecting and Using Materials in Concrete Pavements	17
Sustainable Strategies for Construction of Concrete Pavements	21
References	24

What is Pavement Sustainability?

Key Points

- Sustainable pavements should achieve the engineering goals for which they were constructed; preserve surrounding ecosystems; use financial, human, and environmental resources economically; and meet human needs such as health, safety, equity, employment, comfort, and happiness (Van Dam et al. 2015).
- Sustainability is context sensitive, meaning that there is not a single solution that fits all circumstances. Instead, each circumstance requires a unique approach to design, materials selection, and construction.
- Sustainability requires the adoption of life-cycle thinking that considers all phases of the concrete pavement, including material production, design, construction, use, maintenance and rehabilitation, and end of life. This manual focuses on the first three phases, but the others are equally, if not more, important.
- Our current knowledge and practices are imperfect but evolving. Sustainability is a journey, not a destination, and the practices presented in this manual are steps moving the industry in the right direction along a path representing progress toward sustainability.

Background

It is recognized that the built environment has a significant impact on the economic and social well-being of humanity, as well as impacting the natural environment. To better consider these impacts, both positive and negative, an increasing number of agencies, companies, organizations, institutions, and governing bodies are embracing principles of sustainability in managing their activities and conducting business (Van Dam et al. 2015). Recently, the Federal Highway Administration (FHWA) has expended considerable efforts to advance the application of sustainability principles to pavements through the Sustainable Pavements Program (FHWA 2018), which maintains a website that provides a clearinghouse of information, including references, technical briefs, publications, and recorded webinars. Specific to concrete pavements, a number of excellent documents have been generated, including the following:

- *Towards Sustainable Pavement Systems: A Reference Document* (Van Dam et al. 2015)—This is an extensive reference document covering all aspects of pavement sustainability, including all pavement types.
- *Pavement Sustainability* (Muench and Van Dam 2014)—This tech brief provides an introduction to pavement sustainability concepts and how they are applied as best practices in the industry, focusing on current and emerging technologies and trends.
- *Strategies for Improving Sustainability of Concrete Pavements* (Snyder et al. 2016)—This tech brief focuses specifically on sustainability considerations for concrete pavement systems, covering all aspects of the pavement life cycle.

These documents, as well as others, will be heavily relied upon in this chapter. The reader is encouraged to visit the [FHWA Sustainable Pavements Program website](#) (FHWA 2018) for the latest updates on this dynamic topic.

Defining a Sustainable Pavement

Most definitions of sustainability begin with that issued by the World Commission on Environment and Development, often referred to as the *Brundtland Commission Report* (WCED 1987):

Sustainable development is development that meets the needs of the present without compromising the ability of future generations to meet their own needs.

Although this simple statement captures the essence of sustainability, it is common to describe sustainability as being made up of the three components of environmental, social, and economic needs, collectively referred to as the “triple bottom line.” The assessment of these components over the life cycle provides a framework for more broadly considering sustainability within a project, regionally, or even from a national or global perspective. More “sustainable” features or projects are those that balance these three needs, being economical and environmentally benign or beneficial, while providing social value.

In a recent FHWA document, a sustainable pavement is described as one that achieves its specific engineering goals, while, on a broader scale, it (1) meets basic human needs, (2) uses resources effectively, and (3) preserves/restores surrounding ecosystems (Muench and Van Dam 2014). It must be remembered that sustainability

is context sensitive, and thus the approach taken in one circumstance might not be the same approach to be taken in another. Each pavement application is unique, so the process of selecting materials, design, and construction must be integrated to capitalize on the opportunities that arise to maximize sustainability.

Yet, there are certain opportunities that exist in concrete pavement materials and design that can be considered “low-hanging fruit” because they are almost always economically, environmentally, and socially advantageous. One example, discussed later, is to reduce the portland cement content in concrete mixtures through the use of supplementary cementitious materials (SCMs) and/or optimized gradations that allow for a reduction in overall cementitious materials content. Such opportunities are presented in the following sections of this chapter.

Regardless, a “sustainable pavement” as defined here is an aspirational goal to be worked toward. It is not fully achievable today, but ultimately it may be achievable at some point in the future as sustainability best practices continue to evolve. The focus of this chapter is on making choices in design, materials, and construction that move the industry in the direction of enhancing sustainability into the future.

The Pavement Life Cycle

This chapter highlights “sustainability best practices” for the design, materials selection, and construction of concrete pavements, considering the processes, actions, and features that advance the state of the practice toward more sustainable pavements. As illustrated in Figure 2-1, pavements have a complex life cycle that includes materials extraction and production, construction, use, maintenance, and end of life.

Design also plays an important role, influencing the sustainability of new construction as well as maintenance, rehabilitation, and ultimately reconstruction of the existing pavement. It has been common to place considerable attention on the materials and construction practices used for new pavements, yet maintenance and rehabilitation activities are highly impactful from a pavement life-cycle perspective. Further, the use phase can have the largest impact from a sustainability perspective, particularly on high traffic-volume pavements, due to vehicle-pavement interaction, which influences fuel consumption as is discussed later in this chapter. The final phase is end-of-life, which, as illustrated, feeds back to materials and construction. Each phase can be summarized as follows (Van Dam et al. 2015, Snyder et al. 2016):

- **Material production.** Material production includes all processes in the acquisition (e.g., mining) and processing (e.g., manufacturing, and mixing) of pavement materials. It also includes transportation of materials to the point of production (e.g., concrete plant and aggregate stockpiles). The material production phase ends at the gate of the plant from which materials are being transported to the site.
- **Design.** The design stage refers to the process of identifying the structural and functional requirements of a pavement for given site conditions (i.e., subgrade, climate, present and future traffic, existing pavement structure, etc.), as well as the determination of the pavement structural composition and accompanying materials. It includes new pavement, rehabilitation, and reconstruction.
- **Construction.** The construction stage includes all processes and equipment associated with the construction of the initial pavement. This includes transportation of materials from the gate to the site and all processes and equipment used to construct the pavement from initial subgrade preparation until final finishing, curing, and joint sawing and sealing. Impacts due to construction also include disruption to traffic and local noise and pollution affecting surrounding communities.
- **Use phase.** The use phase refers to the operation of the pavement and its interaction with vehicles, people, and the environment. Many factors are considered, with the dominant one being the consumption of fuel and corresponding generation of emissions that are related to the pavement. Other interactions between the pavement and the environment are also considered.
- **Maintenance/preservation.** These are activities applied at various times throughout the life of the pavement that maintain its overall serviceability. Impacts are both positive (e.g., a pavement is made smoother, thus reducing fuel consumption and emission generated from vehicles using it) and negative (e.g., energy and materials consumed in the activity).
- **End of life.** End of life refers to the final disposition and subsequent reuse, processing, or recycling of the pavement after it has reached the end of its useful life. Although landfilling is listed, this is not a preferred alternative and the practice is highly discouraged.

Additional information on each phase and its importance with regard to concrete pavement sustainability is provided in subsequent sections of this chapter.

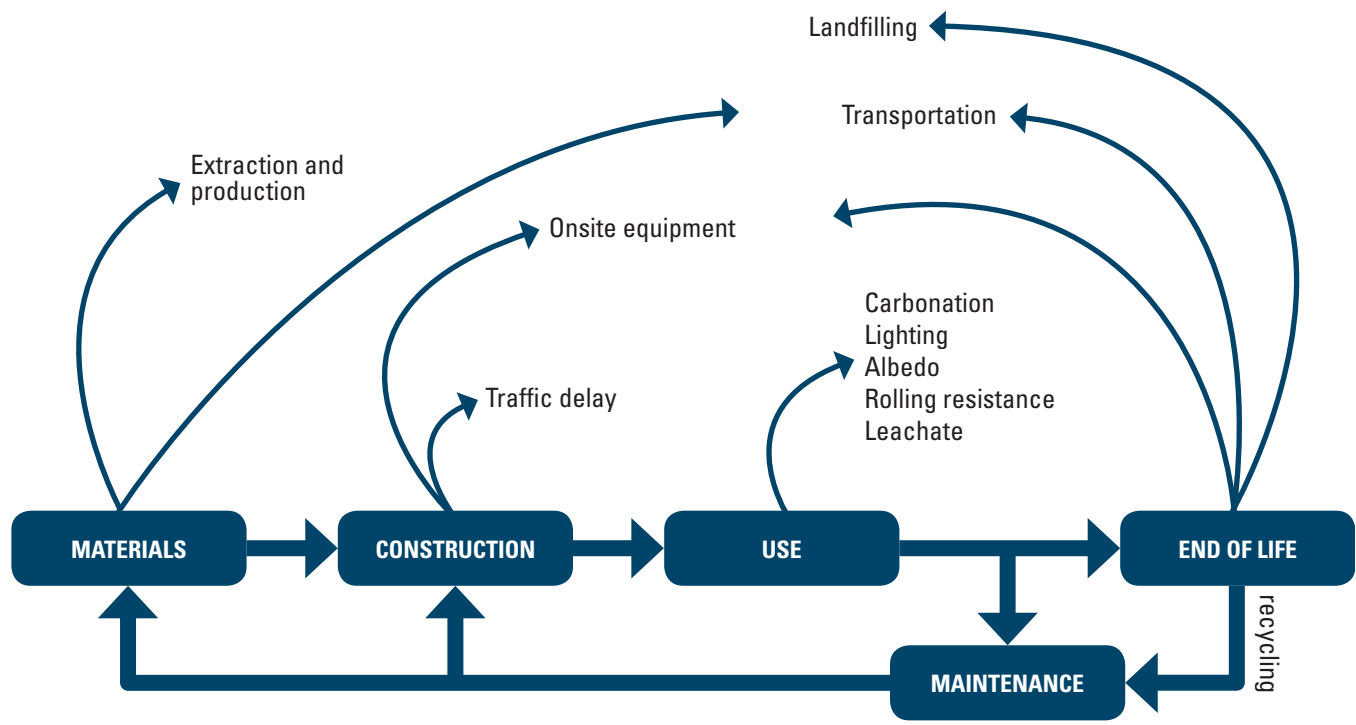

Recreated from Santero et al. 2011, © 2011 Elsevier B.V. All rights reserved. Reprinted with permission from Elsevier

Figure 2-1. Pavement life-cycle phases

Assessing Pavement Sustainability

The pavement life cycle is complex and there are multiple attributes that must be considered when assessing sustainability to assist in the decision-making process and to avoid unintended consequences that may result in a benefit in one phase but a high cost in another phase or phases. There are four general measurement tools, or methods, that are used alone or in combination to quantify various aspects of sustainability (Muench and Van Dam 2014).

- **Performance assessment** entails considering performance through assessment of specified physical attributes deemed necessary for a pavement to meet its intended function. Examples of performance assessment include condition ratings, pavement structural capacity, pavement ride quality, and frictional characteristics in support of safety.
- **Life-cycle cost analysis (LCCA)** is a commonly used economic analysis for evaluating the total cost of an investment option over its entire life (Walls and Smith 1998). Most state departments of transportation (DOTs) practice LCCA to some degree to assist in selecting the preferred pavement alternative for major projects, and various software tools are available to assist in the analysis, with the FHWA's RealCost (FHWA 2011) being most prevalent (Rangaraju et al. 2008).
- **Life-cycle assessment (LCA)** is a technique that can be used to analyze and quantify the environmental impacts of a product, system, or process. Life-cycle assessment, in particular as applied to pavements, is an evolving field of study. The International Standards Organization provides overarching guidance for LCA, but specific standards for use with pavements are still being developed (UCPRC 2010). As a result, pavement LCA results must be carefully scrutinized because their data sources and system boundaries (i.e., what processes are and are not considered) tend to vary between individual tools and studies. Guidelines are currently under development by the FHWA to address current gaps with regard to pavement LCA, and product category rules and environmental product declarations are currently entering the market for various paving materials.
- **Rating systems** are essentially lists of sustainability best practices with an associated common metric. This metric, usually a points based system, allows each best practice to be quantified and compared using a common unit. Most often, some type of weighting is used within the rating system in which one or more points are assigned to a best practice based on the level of its perceived positive impact. Generally, rating systems address more than just pavements, although several of the more popular ones include many pavement-related items.

The FHWA's INVEST (FHWA 2012a) and Greenroads (www.greenroads.org/) are two examples of mature sustainable highway rating systems that include pavements.

Consideration of Trade-Offs

Sustainability is a broad systems characteristic encompassing virtually every impact that a system has on the economy, environment, and society. It is therefore arguable that most pavement features and qualities support sustainability goals in one way or another. However, it is unlikely and, in many cases, undesirable that all such features should be included in a given pavement. This is because some features support one sustainability objective but are in opposition to another, or because some features are mutually exclusive.

For instance, it may be desired to incorporate recycled concrete aggregate (RCA) in the new concrete mixture to be used on a rural paving project, but the nearest source of RCA is 100 mi away while an acceptable local extracted aggregate is only 5 mi away. Further, the inclusion of the RCA would require mixture adjustments that require an additional 50 lb of portland cement per cubic yard of concrete. In these instances, it is necessary to analyze the available options within the context of sustainability in order to make the best choice.

As described by Van Dam et al. (2015), a choice between multiple alternatives essentially represents a consideration of “opportunity cost,” the cost of an alternative that must be foregone in order to pursue a certain action (Investopedia 2018). In the previous example, if the locally extracted aggregate is selected in favor of the nonlocal RCA, the difference in value between the two represents an opportunity cost. The difficulty is in determining the value of the alternatives in a sustainability context.

In classic economics, value is usually expressed solely in monetary units (i.e., dollars). However, value in a sustainability context has many different metrics expressed in many different units, some of which may be controversial and/or difficult to quantify. Some examples of sustainability value include life-cycle cost, greenhouse gas (GHG) emissions, energy use, water/air quality, waste generation, scenic views quality, art, community context, history, habitat continuity, and performance life. Historically, the value of alternative pavement features has been overwhelmingly based on economics, and most often based solely on initial construction cost. While important, initial cost likely represents a narrow and incomplete view of the overall costs and benefits of a particular feature.

Ultimately, the consideration of trade-offs is essentially a benefit/cost analysis done more holistically (i.e., considering more than just economics). When conducting a benefit/cost analysis of sustainable pavement features, it is important to use a consistent approach in analyzing the trade-offs to avoid introducing unintended bias, even if benefits and costs are difficult to quantify. In general, these considerations involve the following: priorities and values of the organization or project, pavement performance, cost, impact magnitude and duration, and risk. None of these considerations is new, so consideration amounts to a formal articulation of what they are. For more information on these basic trade-off considerations, see Van Dam et al. (2015).

Sustainable Strategies for Concrete Pavement Design

Key Points

- Pavement design is the process of identifying functional and structural requirements, including the design life and constraints, and gathering key inputs and selecting pavement type and associated materials to determine layer thicknesses to meet desired performance. Multiple alternatives are often generated from which the preferred alternative is selected in terms of life-cycle costs, environmental impacts, and societal needs.
- Design considerations may include expected life, smoothness, surface texture as it impacts friction and noise, splash/spray and stormwater runoff, future maintenance, reliability, ability to accommodate future utility installation, surface reflectivity, and aesthetics.
- The consideration of payback time, which is the period between the initial environmental impact and the time to achieve a zero difference compared to the standard approach, is an important design consideration.
- Sustainability encourages the use of advanced approaches to design, including mechanistic-empirical (ME) design methods.

Surface and Structural Performance

Pavement smoothness, texture, and structural responsiveness all contribute to vehicle fuel consumption and related emissions. It is well known that pavement smoothness is a key performance indicator and is a major consideration in pavement design, whether done empirically (e.g., 1993 American Association of State Highway and Transportation Officials [AASHTO] *Guide for Design of Pavement Structures*) or through ME design (e.g., AASHTOWare Pavement ME Design). The primary argument made is that pavement smoothness is of direct concern to the traveling public because it impacts the users' experience as they utilize the facility. Smoothness also affects vehicle life and damage to freight and thus has direct and measurable economic costs to the user.

However, pavement smoothness, and to a lesser degree texture and structural response, also affect vehicle fuel consumption (Chatti and Zaabar 2012). Vehicles using a rough pavement (i.e., one with a higher International Roughness Index [IRI] value) will consume more fuel than those using a smoother pavement (i.e., one with a lower IRI value). This additional roughness not only has direct economic costs in additional fuel consumed, but environmental and societal costs as well through the generation of additional GHGs (e.g., carbon dioxide [CO₂]) and other harmful emissions (Van Dam et al. 2015). This is a major reason to design and construct pavements to be smooth initially and to maintain them in a smooth condition over their service lives.

This impact is most critical in pavements exposed to higher traffic volumes. As traffic volumes decrease, the saving in fuel consumption may be overtaken by

the extra environmental costs of constructing and maintaining the pavement in smooth condition. Research has demonstrated that for pavements carrying heavy traffic volumes, the environmental benefits of keeping the pavement in a smooth condition far outweigh the negative environmental impacts of materials production and construction associated with intervening maintenance or rehabilitation (Wang et al. 2012).

Yet, this same study conclusively demonstrated that for lower traffic-volume pavements, the opposite was true, emphasizing little environmental justification for keeping low-volume pavements in a smooth condition (note that other considerations remain, justifying a minimum smoothness criteria for low-volume pavements, including damage to vehicles, freight, human comfort, and safety).

In addition to roughness, pavement texture is also known to contribute to vehicle fuel consumption. Pavement texture can be separated into three components based on the maximum wavelength from a true planar surface: megatexture, macrotexture, and microtexture. Of these three, the main contributor to impacts on fuel efficiency is macrotexture (wavelengths of 0.02 to 2 in.).

For concrete pavements, directional textures (e.g., tining, grooving, and grinding) have made the assessment of macrotexture more difficult. Work conducted by Chatti and Zaabar (2012) found that macrotexture had a significant influence on vehicle fuel efficiency (particularly heavy trucks moving at slow speeds), but it was less important than smoothness. Further, it was felt that positive macrotexture (stones and textures protruding upward from the average surface elevation)

had a larger effect than negative macrotexture (downward gaps or grooves below the average surface). This is due to the bending of the tire tread around the protrusions consuming energy. Therefore, from a concrete pavement perspective, directional textures should be constructed that emphasize negative macrotextures versus positive macrotextures.

The impact of pavement structural responsiveness on vehicle fuel efficiency is an active area of research, with new information continually emerging. This mechanism reflects the consumption of vehicle energy in the pavement itself, as the pavement materials deform under passing vehicles. This includes delayed deformation of viscoelastic materials and other damping effects that consume energy in the pavement and subgrade (Van Dam et al. 2015) and has been characterized in terms of the deformation of the pavement such that the moving wheel is continually on a slope as it ascends the deflection basin (Flugge 1975, Chupin et al. 2013, Akbarian et al. 2015).

Pavement structural responsiveness to loading is determined by layer thicknesses, stiffnesses, and material types that determine viscoelastic and elastic pavement response under different conditions of wheel loading and vehicle speed, as well as temperature and moisture conditions. For a given pavement structure, the effect of this mechanism on viscoelastic materials can be highly dependent on daily and seasonal changes in pavement temperatures (particularly near the surface), as well as vehicle speed and loading (Akbarian et al. 2015). As such, the impact structural responsiveness has on vehicle fuel efficiency is constantly in flux, changing with time and conditions.

Models developed from bench-top experiments indicate that for stiffer pavement systems, such as concrete pavements, the impact of deflection-induced fuel consumption can be minimized and a significant impact on pavement life-cycle calculations can be realized (Akbarian et al. 2015). Comprehensive validation of the impact of pavement structural responsiveness of vehicle fuel consumption is ongoing, controlling for roughness and macrotexture, to calibrate models that can be used to make design and management decisions (Van Dam et al. 2015).

From a concrete pavement design perspective, these results suggest that for high-volume pavements (i.e., most interstate highways and arterials), there are considerable environmental and societal benefits in designing them to be smooth and to remain smooth throughout their design life. This could mean the

selection of design types (such as continuously reinforced concrete pavement [CRCP]) and design elements (e.g., thicker slabs, stronger bases, better load-transfer devices, good drainage) that will result in long-term smoothness while permitting smoothness to be easily and repeatedly restored through a surface renewal preservation technique like diamond grinding.

Regardless of whether roughness, macrotexture, or structural responsiveness are considered, these effects will not be as important for lower traffic-volume pavements as other characteristics such as longevity, aesthetics, and ease of repair. For example, in urban environments, local, low-volume pavements with aesthetic features that can be readily maintained and restored after an underground utility is repaired, will be an attractive choice. Concrete pavements with these features might include thin pavements with short joint spacing or concrete pavers. Thus, again, the design alternative from a sustainability perspective is context sensitive.

The selection of the appropriate functional and structural pavement design life is influenced by traffic, subgrade support, and environmental factors and should include the consideration of higher initial economic costs and environmental impacts associated with longer-life designs versus higher future costs and environmental impacts associated with shorter life designs because of the need for additional maintenance and rehabilitation activities.

End-of-life alternatives or use of extremely long-lived pavement, which will not be expected to need reconstruction over a period of 50 years or more, should also be considered. Economic impacts of these types of decisions are commonly considered through LCCA. A framework is currently under development through the FHWA's Sustainable Pavements Program to consider pavement environmental impacts through the use of LCA; whereas, rating systems, such as INVEST (FHWA 2012a) and Greenroads (www.greenroads.org/), are available to broadly assess the overall sustainability of pavement design alternatives.

Mechanistic-Empirical Design

Mechanistic-empirical pavement design methods offer greater opportunity than the empirical design methods of the past to consider alternative pavement structures, materials, and construction procedures, including comparisons of alternatives offering improved cost and environmental sustainability (Snyder et al. 2016). Whereas empirical pavement design methods can only consider how pavements perform within the range of

conditions (e.g., material types, pavement types and design features, environmental conditions, and traffic loadings) upon which the design model was calibrated, ME design can more directly consider material properties and slab geometry to calculate how the pavement reacts to applied vehicle and environmental loading, relating those parameters directly to pavement performance through available response and performance models.

An ME approach thus allows the consideration of designs featuring the use of new materials and geometries that may not have been previously encountered. It also allows a design to be better optimized for given soil and climatic conditions and thus has greater context sensitivity for a given site. An ME design can estimate critical concrete pavement distresses (e.g., slab cracking, faulting, joint spalling, and punchouts) and roughness (i.e., IRI) versus time, which allows the designer to consider alternative trigger levels for maintenance and rehabilitation.

The AASHTOWare Pavement ME Design software is currently the ME tool most commonly used by state highway agencies for pavement design (both for new pavements and overlays), although some state highway agencies, industry organizations, and countries use other concrete pavement ME design procedures and software tools. Mechanistic-empirical design methods are available for both new concrete pavements and rehabilitation design. Structural rehabilitation strategies for concrete-surfaced pavements include concrete (bonded and unbonded) and asphalt overlays, as well as reconstruction.

The use of the AASHTOWare Pavement ME Design software can provide opportunities by reducing wasteful overdesign and avoiding the use of poor design features. This was illustrated by Mack et al. (2013), who showed that, through thoughtful design, both initial and life-cycle costs and CO₂ emissions could be reduced. The authors used a case study featuring a California highway to illustrate the point.

Santero et al. (2013) also used the AASHTOWare Pavement ME Design software in comparing a number of pavement design alternatives generated using the older AASHTO 1993 *Guide to Pavement Design*. By doing so, the pavement thicknesses were significantly reduced, thus mitigating the costs and emissions from the associated materials and processes (note that it was assumed that performance was not compromised). It was found that significant monetary and GHG savings could be generated through the use of ME design by avoiding wasteful overdesign. The authors noted that

results may differ for different climates and that the perceived advantages of using ME design will differ from project to project (Santero et al. 2013). More detailed discussion on ME design is presented in [Chapter 3](#) of this manual.

Pavement Design Strategies for Longevity

In many circumstances, long-life designs (30 to 60 years) are generally justified for higher volume facilities as they may reduce costs, user delays, and environmental impacts over the life cycle as compared to a standard pavement design. Longer-life pavements typically use more durable materials and/or provide greater structural capacity achieved by increasing pavement thickness, stiffness and/or strength of critical layers, or both (Snyder et al. 2016). Longer-life concrete pavements are designed to resist structural and durability distress over the design life, requiring only periodic retexturing of the surface through diamond grinding to restore smoothness, friction, and noise performance.

These design objectives are achieved by using durable concrete mixtures, adopting slightly thicker concrete slabs placed on nonerrodible bases, using properly designed and corrosion-resistant dowel bars (and reinforcing steel where used), and incorporating stress-relieving design features, such as tied concrete shoulders or wide slabs. A number of state highway agencies have modified their standard designs and specifications to achieve long life for their most heavily trafficked pavement sections, including the following (Tayabji and Lim 2007):

- Illinois—Uses CRCP of up to 14 in. thick on stabilized base. High durability aggregates are used with stringent construction control.
- Minnesota—Uses jointed plain concrete pavement (JPCP) with slab thicknesses of up to 13.5 in. with highly corrosion-resistant dowel bars. A combined aggregate gradation is used with an SCM to reduce permeability, which is assessed using the rapid chloride penetration test (ASTM C1202).
- Texas—Uses CRCP with increased slab thickness and stabilized base, increased steel content, and limited coefficient of thermal expansion (CTE) of the concrete.
- Washington—Uses JPCP with a typical thickness of 12 in. on a hot-mixed asphalt base with top 1 in. of portland cement concrete (PCC) being considered “sacrificial” for future grinding. High corrosion-resistant dowels are used with either widened slab or tied concrete shoulders. A combined aggregate gradation with SCMs is used in the concrete mixture design.

Because of the increased thicknesses, the increased material stiffnesses/strengths, and the use of more durable materials, longer-life designs often have higher initial costs and/or greater initial environmental impacts, but the overall life-cycle costs and environmental impacts are often expected to be less (Snyder et al. 2016).

Design with Local and Recycled Materials

It is common practice to use recycled materials as aggregate in the base and subbase layers as part of a concrete pavement design. Recycled materials, such as RCA, air-cooled blast furnace slag (ACBFS), and even reclaimed asphalt pavement (RAP), have also been used as aggregate in new concrete. These options are often particularly attractive when the original pavement structure is the source of the recycled materials used in the reconstructed pavement.

One concrete pavement design option that is particularly well suited to incorporating recycled materials as aggregate in new concrete is two-lift composite pavement. In this design, the relatively thin upper concrete lift may include abrasion-resistant and more durable aggregates, possibly shipped great distances; whereas, the thicker lower lift uses recycled materials and/or other less suitable local aggregates. In combination, this strategy not only lowers costs, but also reduces environmental impacts, primarily by reducing the environmental burden of transporting materials. It is thus an effective strategy for improving utilization of materials with a lower environmental impact without compromising the surface characteristics of the pavement, thus enhancing sustainability.

The fundamental principles behind preparing a long-lasting mixture are no different for RCA than for conventional concrete. The additional factors that need to be considered in preparing a mixture for use in a pavement that contains RCA are discussed in [Chapter 4, Fundamentals of Materials Used for Concrete Pavements](#). Some agencies may treat RCA like regular aggregate, but consideration should be made to the changes in properties while addressing questions about the source concrete and why it was taken out of service. It is critical that, while striving to improve sustainability by using RCA, the engineering performance of the final pavement should not be compromised (FHWA 2007).

Recycled concrete aggregate should be considered an engineered material for which the properties must be determined prior to use so that appropriate mixture design or construction adjustments can be made as required. The National CP Tech Center has published

an excellent resource for practitioners: *Recycling Concrete Pavement Material: A Practitioner's Reference Guide* (2018). It is available for free download at <https://cptechcenter.org/concrete-recycling/>.

Additional Design Strategies and Features That Impact Sustainability

There are a number of other design strategies and features that can positively impact the sustainability of concrete pavements. These include surface texture, stormwater management, and modular pavement systems, among others.

Surface Texture

Concrete pavement surfaces can be textured in both the plastic and hardened states. This provides options for many different textures, each offering different potential noise and frictional characteristics, which impact environmental and societal aspects of pavement sustainability. The importance of macrotexture with regard to safety and vehicle fuel efficiency and associated emissions has already been discussed, with the desire to create negative macrotexture (characterized by gaps or grooves below the average elevation) in lieu of positive macrotexture (characterized by protrusions above the average elevation). This is most important for high traffic-volume roadways where the small incremental difference is important due to the high number of vehicles.

To create texture in concrete in the plastic state, current practice is to use longitudinal tining to maintain adequate friction while reducing noise generated through tire-pavement interaction compared to the traditional transverse tining used in the past. In hardened concrete, conventional diamond grinding or the specialized grinding and grooving pattern of a next-generation concrete surface (NGCS) provide excellent frictional and noise reduction characteristics, while also generating excellent negative macrotexture. Although the selection of a concrete pavement surface texture can be considered a part of the design process, the successful implementation of that texture in freshly placed concrete, and thus its impacts on pavement sustainability, are highly dependent on construction techniques. The impacts of constructed pavement characteristics are addressed later in this manual.

Stormwater Management

Concrete pavements can be constructed using permeable (also called “pervious”) materials to capture and store stormwater runoff, allowing it to percolate into the ground and thereby recharge groundwater supplies and/or control discharge outflow (Van Dam et al. 2015).

The U.S. Environmental Protection Agency (EPA) (2010) cites the use of fully permeable pavements as a best management practice for handling stormwater runoff on a local and regional basis.

Fully permeable pavements are those in which all pavement layers are intended to be permeable and the underlying pavement structure serves as a reservoir to store water during precipitation events to minimize the adverse effects of stormwater runoff. Examples of two fully permeable concrete pavement structures are shown in Figure 2-2. An FHWA tech brief on fully permeable pavements outlines an overview of pervious concrete and its use in pavement applications (FHWA 2012b).

Structural design methods for fully permeable pavements are empirical in nature and are available from the American Concrete Pavement Association (ACPA), including design software. An ME design approach for fully permeable interlocking concrete pavement validated with accelerated pavement testing is available from the Interlocking Concrete Paving Institute.

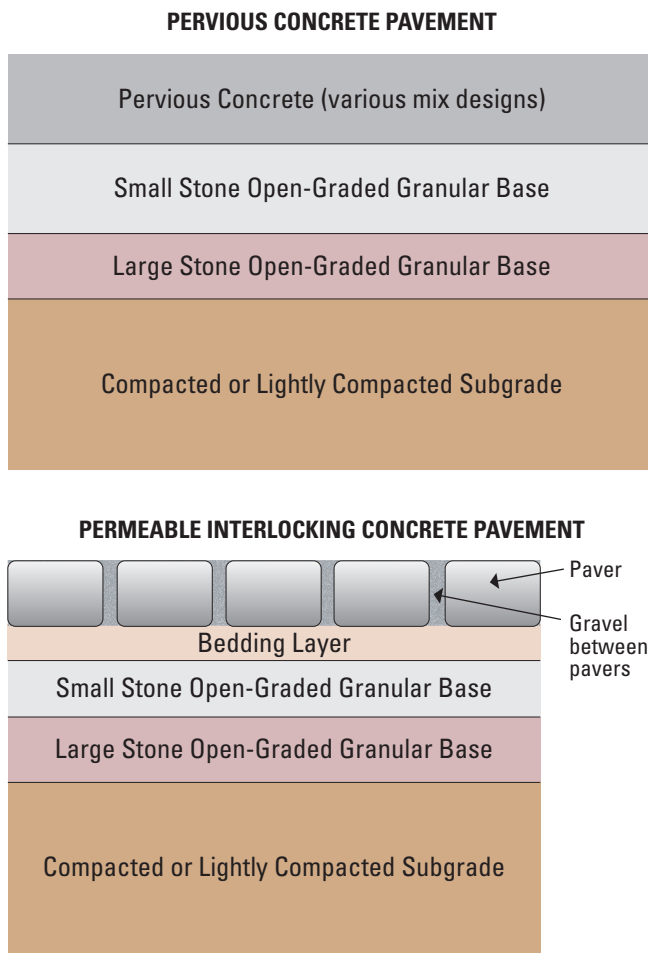

Recreated from Van Dam et al. 2015, used with permission from Applied Pavement Technology, Inc.

Figure 2-2. Examples of fully permeable concrete pavement systems

In North America, it is not common to use fully permeable pavements in areas subjected to high-speed traffic or heavy trucks. Instead, state highway agencies will use fully permeable pavements for low traffic-volume applications, such as for shoulders adjacent to conventional impermeable pavement and on occasion for some low-speed applications carrying trucks.

Surface Reflectivity

The thermal performance of a pavement is defined as the change in its temperature (most often surface temperature) over time as influenced by properties of the paving materials (e.g., surface reflectivity, thermal emittance, thermal conductivity, specific heat, and surface convection) and by ambient environmental conditions (e.g., sunlight, wind, and air temperature) (Van Dam et al. 2015). It is also influenced by evaporative cooling, which is related to ambient conditions, permeability, and the availability of near-surface water (primarily a factor for permeable pavement systems).

The single most important pavement material property affecting thermal performance is solar reflectance (also referred to as albedo), which is a measure of the ability of a surface to reflect solar radiation. Solar reflectance values range from 0 (no sunlight reflected) to 1 (all sunlight reflected). In general, light-colored materials have higher solar reflectance values than dark-colored materials, but it is recognized that color alone is not the only indicator of solar reflectance (Alleman and Heitzman 2013).

The thermal performance of pavements is believed to be important primarily in urban environments as the presence of relatively dark, impermeable surfaces covers upward of 30 percent of the land area and is a contributor to what is commonly called the urban heat island effect (UHIE). The UHIE is most noticeable on a summer afternoon when it is observed that urban areas are generally warmer than surrounding rural locations (Jones et al. 1990). This forms an island of heat over the urban area, as illustrated in Figure 2-3 (EPA 2003).

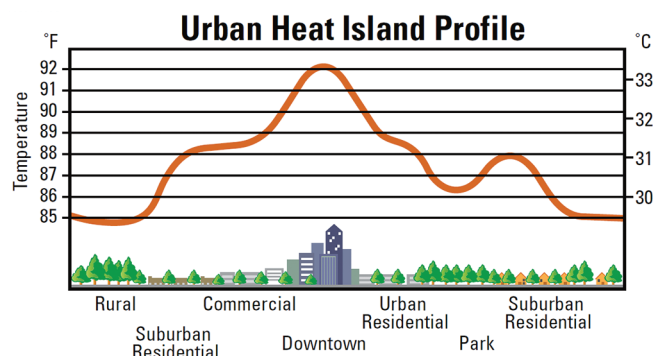

EPA 2003

Figure 2-3. Heat islands for various areas of development

As illustrated in Figure 2-3, the rise in the temperature of man-made urban areas is quite noticeable compared with the other land uses. The negative effects of the increased air temperatures include greater energy demands (and the associated environmental impacts of increased electrical energy production) when and where increases in air temperatures result in greater use of air conditioning to cool buildings. Further, in places that are already burdened with high temperatures, the UHIE can make cities warmer, more uncomfortable, and occasionally more life threatening (FEMA 2007).

The major question that arises is to what degree pavements in general, and pavement surface reflectivity in particular, contribute to the UHIE. Multiple studies have concluded, through simulation modeling, that low solar reflectance of paving materials can contribute to the formation of urban heat islands (Akbari et al. 1999, Taha et al. 1999, Rose et al. 2003, Rosenzweig et al. 2006, Millstein 2013, Li et al. 2013, Santamouris 2013). Yet these studies did not consider the full complexity of the problem because urban areas have differing sizes, pavement densities, tree canopies, building patterns, latitudes, and climates (Navigant 2010).

Furthermore, factors such as building ordering and heights create three-dimensional “urban canyons” that impact the flow of air through the urban environment and appear to have a significant effect on urban warming (Sobstyl 2013). Since pavements are for the most part at ground level, they are often shaded by buildings and trees. As a result, this area of research continues to advance, and at this time, there is not a consensus on the impact of pavement reflectivity on the UHIE or other local, regional, or global environmental factors.

In addition to UHIEs, there is a growing body of knowledge that relates planetary solar reflectance to global warming as a result of changes in radiative forcing. Although the concept of radiative forcing is fairly straightforward, in practice it is a very complex phenomenon. A common and accessible definition is that radiative forcing is the difference of insolation (sunlight) absorbed by the Earth and energy radiated back into space (Wikipedia 2018).

Factors contributing to radiative forcing are many and complex, and they often interact with each other. They include the natural incoming solar irradiance (which changes with solar activity), atmospheric aerosols, GHGs, cloud microphysics, and changes to the land surface (Cubasch et al. 2013). The latter two categories (changes to the atmosphere and land surface)

are influenced by both natural processes and human activities. The contribution of pavements to radiative forcing lies primarily in changes to the land surface by changing surface albedo.

Multiple studies have used modeling to demonstrate how increasing roof and pavement albedo can reduce urban solar heat gain, lower urban surface temperatures, and thereby decrease both convection and thermal radiation of heat into the atmosphere (Akbari et al. 2009, Millstein and Menon 2011, Akbari and Matthews 2012). Related work concluded that the global warming mitigation effect of increasing the average albedo of urban environments worldwide by 0.1 could be on the order of 49 billion short tons of CO₂ equivalents, with roughly 45 percent of this derived from increasing the albedo of pavements by at least 0.15 for roadway and parking surfaces (Menon et al. 2010). Work by the same team, focusing on the continental US, and using a more advanced model, found increased regional variability but concluded that overall even greater impacts could be achieved by increasing the average urban albedo of horizontal surfaces (Millstein and Menon 2011).

In a recent review of climate impacts of albedo, Xu et al. (2016) concluded through a comparative analysis of results from different studies that an increase in albedo of 0.01 results in a radiative forcing change from -2.9 to -1.3, reducing air temperature by 0.18°F on average. This would result in an annual global warming potential savings of up to 13 lb/yd² of CO₂ equivalents of urban area. Yet, reflecting on the complexity of this issue, conclusions drawn in another paper found that an increase in average surface albedo will result in less local cloud cover, thus actually increasing local incident solar radiation and potentially contributing to global warming (Jacobson and Ten Hoeve 2012).

In closing, the use of high-albedo pavements to provide global cooling through radiative forcing is currently uncertain, although most modeling efforts suggest a modest impact. If there is no interaction with clouds, more reflective pavements could provide important global cooling benefits. Once feedback to cloud formation is accounted for, however, the answer is not definitive and may depend on whether pavement albedo is universally increased in all locations or whether high-albedo pavements are constructed in select locations where effectiveness is demonstrated. The question of whether global changes in pavement albedo can provide global cooling benefits remains an active area of research.

In addition to thermal performance, the color and texture of the pavement can also aid in reducing the amount of lighting needed (Gajda and VanGeem 2001, Adrian and Jobanputra 2005, MnDOT 2010, FHWA 2012c). Lighter, more reflective pavement surfaces, or those with less texture, can provide the same level of luminance (the intensity of light emitted from the surface) at reduced illuminance (the amount of luminous flux per unit area) values. This can result in energy savings either by increasing the spacing between luminaries or by reducing the required lumens per luminary to achieve similar illumination.

Pavement Aesthetics

“Aesthetics” refers to the nature and appreciation of beauty. In the context of infrastructure, such as pavements, it refers to general appearance (typically meaning “visual appearance” but not necessarily excluding other senses) and usually implies a measure of beauty and harmony with the surrounding environment.

For most pavement applications, there are limited opportunities to address aesthetics because to a large degree pavements are designed and materials selected for engineering reasons rather than artistic ones (Van Dam et al. 2015). There are situations (most often in urban environments), however, where pavement aesthetics are important to the design—usually altering the color and/or texture of the pavement material. One example is using color and patterns to create increased visibility, separating pedestrian and bicycle features, as shown in Figure 2-4.

For concrete pavements, the normal gray color can be made nearly white through the use of white cement and/or slag cement, and pigments or stains can be used to create a range in colors. Concrete can also be patterned

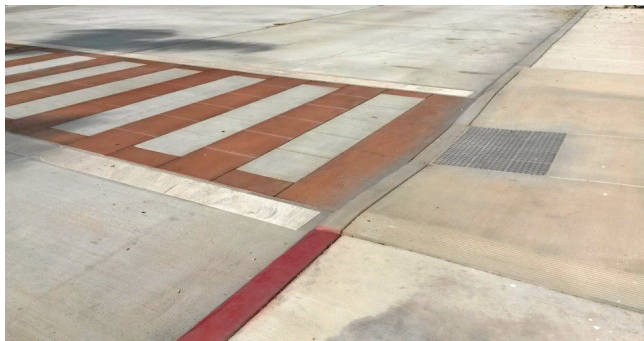

Thomas Van Dam

Figure 2-4. Using color and patterns in concrete to identify pedestrian crosswalk

to add aesthetic appeal. A similar effect can be achieved through the use of interlocking concrete pavers. Figure 2-5 shows how a combination of concrete pavement types, including different colored permeable interlocking concrete pavers and rain gardens, can add aesthetic appeal while addressing stormwater in Milwaukee, Wisconsin.

Modular Pavement Systems

Modular pavement systems are composed of precast concrete components that can be used to rapidly construct or repair a section of roadway, thereby reducing user delays, or to provide an aesthetically pleasing design (Snyder et al. 2016). Modular pavements offer certain sustainability advantages. High quality is possible with precast concrete pavement systems because the concrete is cast and cured under controlled conditions and is not exposed to potentially damaging field conditions and traffic while curing. This can permit the use of thinner and longer-lasting structures that reduce environmental impacts over the pavement life cycle as long as durability is ensured and consideration is given to using reduced cement contents and SCM replacements to reduce GHG emissions.

Precast concrete slabs are one type of modular pavement that is typically used for very short-duration construction windows to minimize user delays and to provide better performance than might be obtained using cast-in-place construction. Another type of modular pavement system is interlocking concrete pavers, which are typically used on low-speed facilities or in urban areas to provide aesthetically pleasing roadways (ASCE 2010, Smith 2011). Some removable and reusable modular pavement systems also allow easy access for utility repairs, thereby reducing repair costs, maintaining aesthetics, and minimizing user delays.



Thomas Van Dam

Figure 2-5. Concrete pavement and permeable interlocking concrete pavers in Milwaukee, Wisconsin

Key Points

- For concrete pavements, the largest environmental impact is tied to the production of portland cement. Significant reduction in GHG emissions and energy consumption associated with concrete can only be accomplished by reducing the amount of portland cement clinker in the concrete.
- Portland cement clinker can be reduced through the use of lower cementitious content mixtures incorporating optimized aggregate grading and by increasing the use of SCMs.
- The longevity of concrete is very important for sustainability because it reduces life-cycle costs and environmental impacts. Therefore, the durability of the concrete is extremely important to avoid premature failure.
- Maximizing the use of local materials and/or recycled, coproduct, or waste materials (RCWMs) reduces the amount of material that has to be transported, saving money and reducing emissions. In the case of RCWMs, it also reduces the need for virgin materials while diverting materials from disposal in landfills, putting them to positive use.
- Materials choices are context sensitive and thus must be considered broadly to enhance sustainability over the life cycle.

Background

The material phase encompasses the extraction and processing of the raw materials, transporting these materials to the plant, the concrete mixture design and proportioning processes, and the plant operations necessary to place materials into trucks for transportation to the project site. A few strategies that can be used to improve the sustainability of concrete pavements include the following:

- Use RCWMs wisely to reduce cost and environmental impact while maintaining or improving pavement performance.
- Reduce the amount of portland cement in concrete paving mixtures while maintaining or improving pavement performance through the use of lower cementitious content mixtures, incorporating optimized aggregate grading, and by increasing the use of SCMs.
- Ensure the longevity of the concrete in the environment in which it serves to avoid premature failures due to durability issues.

These are addressed in greater detail below.

Use of Recycled, Coproduct, and Waste Materials

It is important to understand the differentiation between recycled, coproduct, and waste materials; although they are similar, there are important distinctions. The following definitions were provided by Van Dam et al. (2015):

- **Recycled materials**—Materials obtained from an old pavement and included in materials to be used in the new pavement. A common recycled material is RCA. Depending on the regional market, these materials would be “waste” if not recycled, ending up in a landfill.
- **Coproducts**—Materials derived as part of another process (often industrial but possibly agricultural) that brings value to the overall process. For pavement applications, some of the most common coproducts result from the production of pig iron for steel making, including slag cement and air-cooled iron blast furnace slag aggregate.
- **Waste**—Materials that normally would be sent to a landfill, for which the cost of transport and processing is the only source of economic value. If the material has value beyond this, it is no longer considered a waste, but instead a coproduct. In some regional markets, fly ash can be categorized as waste; whereas, in other markets, it is clearly a coproduct because it has economic value beyond the cost of transport and disposal.

Although the differences may seem subtle, they are important when accounting for environmental impact in a process such as LCA. This is especially true with coproducts because the environmental burden of their production must be equitably distributed among the various processes using the material. How this can be done is discussed in Van Dam et al. (2015).

As an example, it must be understood that some of the burden involved in the production of the pig iron should be allocated to slag cement in a methodical and agreed-upon way. Along the same lines, as fly ash becomes increasingly scarce and therefore more valuable, it will no longer be considered as waste but instead a coproduct. When this occurs, some of the environmental burden of the originating process—the burning of coal to produce electricity—will be allocated to the fly ash and thus be borne by the concrete. In this way, all the environmental flows within multiple processes are accounted for accurately.

One other important consideration in the use of RCWMs is the mode and distance that they are transported. This must be considered on a project-by-project basis. The use of an RCA, for example, may enhance overall sustainability if the concrete pavement is to be recycled in place as base or subbase. But it may actually be environmentally damaging if a project requires the use of RCA at some set percentage to meet a “sustainability” goal, yet the nearest supply is located a great distance away requiring the need to ship it by truck. The energy consumed and emissions generated by the trucks can easily overcome any advantage of using the RCA compared to a suitable locally available material. Such unintended consequences must be avoided if true sustainability is to be enhanced.

Cementitious Materials and Concrete Mixtures

Concrete is basically a mixture of aggregate bound together by a hydraulic cement paste that is created when water is mixed with hydraulic cement. Initially, the paste is plastic, allowing the concrete to be mixed, transported, placed, consolidated, and finished. Chemical reactions between the hydraulic cement and water cause the paste to harden, turning the concrete into a rock-like mass. The hydraulic cement used today is most commonly a blend of portland cement (AASHTO M 85/ASTM C150); SCMs, such as fly ash, slag cement, natural pozzolans, etc.; and ground limestone. Chemical admixtures are almost always employed to modify the behavior of the fresh and hardened concrete, making it easier to place, enhancing its strength, and increasing its durability. The relevance of each of these materials with respect to sustainability is discussed below.

Portland Cement

Portland cement is manufactured by pyro-processing raw materials, dominated by limestone, in a rotary cement kiln at high temperatures (2460 to 2640°F). The consumption of fuel (which differs regionally, consisting of pulverized coal, natural gas, used tires,

waste industrial oils and solvents, and, in some cases, biomass) is responsible for a significant portion of the GHG emissions in cement production, but more than half of the production-related GHG emissions are released due to the decomposition of limestone (CaCO_3) into lime (CaO) and CO_2 (EPA 2013, Van Dam et al. 2015). While cement kiln energy efficiency has improved dramatically over the last two decades (significantly reducing the energy consumed and emissions associated in pyro-processing, clinker grinding, and other manufacturing processes), cement production remained responsible for approximately 0.5 percent of the US total GHG emissions of CO_2 equivalents in 2013 (EPA 2015).

Supplementary Cementitious Materials

When blended with portland cement, SCMs contribute to the properties of concrete through hydraulic or pozzolanic activity, or both (Kosmatka and Wilson 2016). Hydraulic activity occurs when the SCM chemically reacts with water, forming cementitious hydration products. Pozzolanic activity occurs in the presence of water when reactive siliceous or aluminosiliceous material in the SCM reacts with calcium hydroxide (CH) (a product of the hydration of portland cement) to form calcium-silicate-hydrate and other cementitious compounds, which generally improve concrete long-term strength and durability. SCMs that are commonly used in paving concrete include slag cement (specified under AASHTO M 302/ASTM C989) and fly ash (specified under AASHTO M 295/ASTM C618). Natural pozzolans (also specified under AASHTO M 295/ASTM C618) are increasing in popularity because multiple pressures have reduced the amount of fly ash that is available for use in concrete in many parts of the US.

Slag cement is an industrial coproduct from the smelting of iron in a blast furnace in which molten slag is quenched using water to form a glassy sand-like material containing amorphous oxides of calcium, aluminum, magnesium, and iron. It is subsequently ground to a fineness that is similar to that of portland cement. It is slowly reactive in the presence of water or more vigorously when activated in water in the presence of calcium hydroxide, which is present in the pore solution of hydrating portland cement. Fly ash is considered to be either a waste or coproduct, consisting of spherical glassy particles collected from the flue gases of coal-fired power plants. It varies in composition and mineralogy with the source of coal, how it is burned, and how the ash cools. Under AASHTO M 295, fly ash is classified as either a Class C fly ash or a Class F fly ash.

Natural pozzolans are derived from natural mineral deposits. Some natural pozzolans, such as volcanic ash, require little processing other than drying and grinding before being suitable for use as an SCM; whereas, others derived from shales and clays require sufficient heating to alter their natural structure into a disordered amorphous aluminosilicate with pozzolanic properties (Kosmatka and Wilson 2016). Regardless of the SCM, from a sustainability perspective, the energy and associated emissions necessary for processing need to be accounted for when considering the overall environmental impact of their use in concrete.

Blended Cements

Blended cement is produced and sold by cement manufacturers who intergrind or blend portland cement with fly ash, natural pozzolans, slag cement, and/or limestone to produce binary (two-component) or ternary (three-component) systems as specified under AASHTO M 240/ASTM C595. These materials are classified as Type IP (portland-pozzolan cement), Type IS (portland-slag cement), Type IL (portland-limestone cement [PLC]), and Type IT (ternary blended cement containing portland cement and two additional SCM components). The use of blended cements can significantly reduce CO₂ emissions compared to conventional portland cement while improving concrete durability and long-term strength.

Aggregate Materials

Aggregates make up the largest share of the mass and volume in a concrete pavement structure, whether used as unbound subbase or base material, or as part of an asphalt or hydraulic cementitious bound layer. Although aggregates have relatively low costs and a low environmental impact per unit mass relative to other materials that are used in pavements, they can have a significant impact on pavement sustainability because they are consumed in such large quantities.

Aggregates are sourced from natural sources, recycled pavement materials, coproducts, or other waste materials. The three most common RCWMs used in concrete pavements as aggregate are the following (Snyder et al. 2016):

- **Reclaimed asphalt pavement (RAP)**—This is produced from the millings of an existing asphalt pavement. Although the predominant use of RAP is in new asphalt pavement, it is also commonly used in aggregate bases, and coarse fractionated RAP (FRAP) is successfully used by the Illinois Tollway and others as coarse aggregate in concrete mixtures.

- **RCA**—This is created when concrete is purposefully crushed to create aggregates for use in subbase, base, or paving (asphalt or concrete) applications. When used as base or subbase, both the coarse and fine RCA are often used. RCAs typically contains some unhydrated cement that, when exposed to moisture in compacted bases and subbases, can hydrate to produce base/subbase materials with increased stiffness and other improved properties when compared with those of virgin aggregates (Chai et al. 2009). RCA may also be used in new concrete mixtures, particularly in the lower lift of two-lift paving operations. In new concrete, it is most common to use only the coarse fraction of the RCA.

- **Air-cooled blast furnace slag (ACBFS)**—This is another material that has been used as aggregate in concrete and unbound bases and subbases (Morian et al. 2013).

The use of RCWMs continues to increase for economic and environmental reasons. A proper engineering evaluation must be done when using these materials in concrete paving mixtures to ensure that their properties do not negatively impact the fresh or hardened properties of the concrete. Several publications provide good guidance concerning the use of these materials (ACPA 2009, Van Dam et al. 2012, Morian et al. 2012, Smith et al. 2012, Brand et al. 2012).

As mentioned, a major source of environmental burden associated with aggregate production is transportation. Aggregate must be transported from the source to the jobsite for unbound bases and subbases, and then it must be transported to the concrete plant and then to the project site. Transportation-related impacts primarily involve the burning of fossil fuel in trucks. The energy use and GHG emissions from transport can be larger than those from mining and processing, especially if trucks are used instead of more fuel-efficient transportation modes, such as rail or barges.

Aggregates in Concrete

In addition to the general aggregate sustainability considerations described previously, it is important to consider the impacts of aggregate properties (e.g., aggregate grading and durability) and the use of RCWMs on the sustainability of concrete paving mixtures. For example, aggregate grading can have a profound effect on the amount of cementitious material needed to obtain the desired fresh and hardened properties of the paving concrete. A properly proportioned concrete paving mixture will often have an “optimized” aggregate grading

that increases the aggregate volume through careful consideration of the particle size distribution. This allows for a reduction in cementitious material content while achieving the required fresh (workability, finishability, etc.) and hardened (strength and durability) properties. It is now common to find workable, strong, and durable concrete paving mixtures with total cementitious materials contents of 500 lb/yd³ or less, resulting in both economic and environmental savings compared to previous practices (Snyder et al. 2016). [Chapter 7](#) discusses mixture proportioning and the use of aggregate grading optimization.

In addition to aggregate grading, the importance of aggregate durability on the overall durability of concrete and pavement longevity cannot be overemphasized. Aggregates must meet applicable freeze-thaw durability, alkali-aggregate reactivity, and wear-resistance requirements. The AASHTO provisional protocol PP 65-11, *Standard Practice for Determining the Reactivity of Concrete Aggregates and Selecting Appropriate Measures for Preventing Deleterious Expansion in New Concrete Construction*, should be used to screen aggregates intended for use in paving concrete. SCMs, such as Class F fly ash or slag cement, should be used in alkali-silica reaction (ASR) mitigation strategies if susceptible aggregates are unavoidable.

Concrete Mixture Proportioning and Production

The concrete design, proportioning, and production processes must create a concrete paving mixture that economically meets all design strength, durability, and sustainability requirements over the pavement life cycle (Snyder et al. 2016). Enhancing sustainability of concrete mixtures often entails lowering the total cementitious materials content (e.g., 540 lb/yd³ or less), increasing the replacement of portland cement with high-quality SCMs up to 30 percent or more, and using durable aggregates. In addition, in freeze-thaw environments, the concrete will need to have a properly entrained air-void system and a relatively low w/cm ratio (0.40 to 0.45 is considered good for most applications). Following this guidance will reduce the GHG emissions at production and can be expected to have good long-term physical properties to provide excellent economic, environmental, and societal performance over the life cycle. However, it must be remembered that there is no one “recipe” that will create “sustainable” paving concrete. Instead, the concrete technologist/producer needs to work within project constraints and the available materials to balance a number of discrete and competing variables to enhance concrete mixture sustainability.

Other Concrete Mixtures and Emerging Technologies

There are other types of plant-mixed concrete that are sometimes used in paving applications with beneficial sustainability impacts. One of these is roller-compacted concrete (RCC), a stiff mixture of traditional concrete components that is often proportioned with higher aggregate content and lower cementitious material content than conventional concrete. Roller-compacted concrete is routinely mixed in a pugmill and placed with a high-density asphalt paver, being compacted with rollers similar to asphalt concrete. Another example is pervious concrete, comprising an open gradation of aggregate and lower cementitious material content, which allows precipitation to flow through voids in the concrete surface to be stored in the underlying open-graded base until it can infiltrate into the soil. This reduces stormwater runoff and offers the potential to recharge groundwater supplies.

There are a number of emerging technologies in concrete materials that may enhance the sustainability of concrete paving mixtures, including the development of high-volume SCM/PLC mixtures. These are becoming more common and offer the potential to significantly lower the GHG emissions associated with paving concrete. Another innovation is the development of photocatalytic cements that offer the opportunity to create highly reflective surfaces that remain clean while treating certain air pollutants through a photocatalytic reaction involving nanoparticles of titanium dioxide. Finally, lower carbon cementitious systems are available or becoming available, including calcium-sulfoaluminate and calcium-aluminate cements, geopolymers, and activated fly ash (Van Dam 2010).

Sustainable Strategies for Construction of Concrete Pavements

Key Points

- Achieving quality construction with available materials and construction equipment and expertise impacts the pavement sustainability. In particular, smoothness and longevity are very important from a sustainability perspective.
- Traffic delays in construction work zones may result in negative sustainability impacts where traffic volumes are high and traffic management plans (TMPs) cannot mitigate delays. Safety is also affected by the type and duration of construction work zones.

Background

Pavement construction can affect the overall sustainability of a paving project, although the impacts are generally smaller than what is encountered in other life-cycle phases. According to Snyder et al. (2016), the following are ways in which construction can impact sustainability:

- Fuel consumption during material transport and construction operations
- Exhaust and particulate emissions
- Traffic delays, congestion, and noise emissions generated during construction
- Construction quality, as it impacts pavement performance and overall life
- Constructed characteristics of the pavement surface, which impact surface friction (safety), noise, and possibly fuel efficiency during the use phase

These areas can be categorized as being related to construction operations (first three bullets) or constructed characteristics, including quality (last two bullets). The next section discusses important aspects of pavement construction that can affect pavement sustainability.

Sustainability of Pavement Construction Operations

Elements of construction that impact pavement system sustainability include construction-related energy consumption, effects of construction operations on the surrounding area (including particulate and gas emissions, noise, effects on residents and businesses, and

effects on wetlands and streams), and the economics of construction practices (including user costs resulting from construction-related traffic delays).

Construction-Related Energy Consumption

Pavement construction is energy and emissions intensive, involving excavation, earthwork movement, material processing, production and placement, and compaction/consolidation of the paving layers. The energy consumed by equipment is a function of the efficiency of the equipment and how efficiently it is operated. Other factors that can affect energy consumption and emissions include fuel type (e.g., diesel fuel, gasoline, biodiesel, and compressed natural gas) and the source of power for stationary equipment (i.e., generator driven versus grid powered). Site operations (e.g., haul distances, construction staging, and the need for multi-pass operations) and specific site-related conditions (e.g., quality and maintenance of haul road surfaces) also impact energy efficiency.

Practices for reducing construction-related fuel consumption and emissions include minimizing haul distances with the use of on-site recycling and optimally located staging areas (Ferrebee 2014, Smith et al. 2014), selecting appropriate equipment types and sizes for the job, implementing limitations on idling, using alternative fuels, retrofitting construction equipment with improved emissions control equipment, and using hybrid equipment.

Effects on the Surrounding Area

The use of heavy construction equipment generates engine combustion emissions that may significantly impact local air quality. This equipment is often diesel powered, which produces NO_x, GHG, and diesel exhaust particulate matter (PM) as significant emissions. Diesel exhaust PM emissions are reported as a toxic air contaminant, posing chronic and carcinogenic public health risks (AEP 2012). The EPA has established stringent standards for carbon monoxide, volatile organic carbon, nitrogen oxides, and PM that a vehicle and engine may emit, and manufacturers, refineries, and mixing plants are responsible for meeting those standards.

Construction indirectly impacts the surrounding area by creating congestion, traffic delays, noise, and other adverse effects. Construction analysis programs for pavements, such as CA4PRS (Lee et al. 2005), can be used to analyze the effects of pavement design, construction logistics, and traffic operation options on construction-related traffic delays and construction window policies. The impact of traffic delays on vehicle

energy consumption and GHG emissions relative to the impacts of materials production, construction, and the use phase will depend on the types of delays and the number and types of vehicles affected.

There are a number of strategies available to reduce the impact of construction on the surrounding area (Snyder et al. 2016):

- Strategies to improve air quality associated with pavement construction other than that resulting from vehicle emissions include utilization of effective dust control techniques, regular maintenance of dust collectors at asphalt and concrete plants, and consideration of the proximity of residential and light commercial areas in the selection of plant and materials storage locations.
- Approaches to reducing noise and noise impacts include equipment modifications and proper equipment maintenance, as well as time-of-day restrictions on some (or all) construction activities.
- Practices for minimizing pollution from runoff and erosion include the use of perimeter control barriers (fences, straw bales, etc.), minimization of the extent of disturbed areas, application of erosion control matting or blankets, and site planning to store/stockpile materials away from waterways.
- Traffic delays and disruption of residents and businesses can be reduced by the use of effective traffic control and lane closure strategies, the establishment of performance goals and measures for work zones, the use of project management software to optimize construction sequencing, and the use of intelligent transportation systems to dynamically manage traffic.
- Accelerated construction techniques can also be employed to minimize the duration of construction and associated lane-closure times. The use of materials such as rapid-setting or high early-strength concrete, RCC, and modular concrete are techniques that can accelerate construction.
- Concrete haul trucks and other equipment must be washed out frequently, but concrete wash water is toxic to fish and other aquatic life and can contaminate drinking water supplies if not handled appropriately. Concrete wash water must therefore be prevented from entering waterways, drainage systems, and groundwater. Best practices include the return of all concrete waste and wash water with each concrete truck for disposal at the concrete batch plant. At a minimum, an on-site concrete washout area should be established to collect washout water.

Economics of Construction Practices

Construction practices have a direct bearing on both the initial construction costs and the long-term life-cycle costs of the pavement project. Changes in construction practices that enhance the sustainability of the project (such as noise and pollution reduction procedures, controlling erosion and stormwater runoff, and providing better local access) often incur increased costs, which must be considered and weighed against expected benefits over the life cycle of the pavement to determine their effective impacts. Changes that incur unacceptable economic expense may not be easily adopted, in spite of potential environmental or societal benefits.

In addition, construction often temporarily reduces roadway capacity due to geometric restrictions, reduced speed limits, temporary closures, detours, and other congestion-inducing activities. Highway construction work zones account for nearly 24 percent of nonrecurring congestion in the US, translating to 482 million vehicle hours of delay per year (USDOT 2006). Highway construction work zones are estimated to be responsible for 10 percent of all highway congestion in the US, which translates to an annual fuel loss of \$700 million (Antonucci et al. 2005). For this reason, it is advantageous for heavily trafficked pavements to construct long-lasting concrete pavements that require minimal maintenance or rehabilitation over their design life.

Impacts of Constructed Characteristics on Pavement Sustainability

Construction directly impacts the sustainability of a concrete pavement because it significantly influences pavement performance. Sustainability is improved through increases in pavement performance, such as contributing to longer service life and higher and maintained levels of smoothness and frictional properties (Snyder et al. 2016). These are discussed below.

Construction Quality

Long service life is one of the primary drivers of pavement sustainability, and the ability to achieve a long service life is strongly impacted by the quality of construction. In fact, the potential gains in sustainability afforded by the optimization of structural design, the use of highly durable or recycled materials, and the improved efficiencies in the production of cement and other materials can be completely negated by poor construction quality and improper construction techniques that result in premature failure of the pavement.

In many cases, increases in performance can be achieved with small increases in construction quality and associated reductions in overall variability. A careful review of construction specifications may show where increased levels of quality can be achieved that would positively impact performance. [Chapter 9](#) discusses quality and testing.

There are many aspects of concrete pavement construction for which consistency and quality are essential in order to achieve the full potential for longevity (and, therefore, sustainability) of concrete pavements. These include (but are not limited to) the following:

- String-line setup and maintenance or correct setup for stringless paving (for control of pavement thickness and initial ride quality)
- Concrete plant setup and operation with plant certification
- Equipment setup and hauling (including haul time restrictions in normal and hot weather)
- Placement, installation, and (where applicable) alignment of dowel bars, tiebars, and slab reinforcement
- Placement of the concrete (to minimize segregation and maintain a constant head of material in front of the paver) and consolidation of concrete without overvibration through the use of vibratory frequency monitors and their adjustment with variations in the concrete mixture
- Control of water use at the jobsite, ensuring that no more water is added than called for in the mixture design
- Execution of quality assurance (QA) (i.e., quality control [QC] and acceptance), including monitoring mixture consistency through air, slump, and unit weight testing, as well as thickness control and strength or maturity testing
- Selection and use of curing materials
- Joint marking (to ensure proper panel size and dowel embedment lengths) and sawing operations

Best practices for all these aspects of concrete paving are described in detail in several key references (ACPA 2008, ACPA 2010).

Pavement smoothness is an important pavement construction quality indicator, and achieving a high level of smoothness during initial construction, as well as maintaining it throughout the service life of pavements,

is considered to be a key factor in improving overall sustainability by lowering fuel consumption and reducing vehicle-related emissions. Studies have also shown that, when structural or material durability problems are not present, improvements in initial ride quality translate directly into longer pavement service life (Smith et al. 1997). Obtaining good initial smoothness levels during the construction of new or rehabilitated high traffic-volume roadways, and maintaining those levels of smoothness throughout their service lives, can result in large reductions of use-phase energy consumption and emissions compared to the impacts associated with the use of different materials or construction techniques (Wang et al. 2012). Smoothness acceptance levels should be part of the construction specifications, and smoothness should be an important consideration in maintaining concrete pavements through their design life.

Finishing and Texturing

Concrete pavement finishing and texturing affect pavement sustainability through their potential impacts on service life (which impacts maintenance activities and life-cycle costs), noise, and fuel efficiency generated from tire-pavement interaction, and, of course, safety.

Overfinishing and the use of water as a surface finishing aid must be prohibited because loss of surface durability will result. Manual efforts to remedy minor surface defects in fresh concrete can result in improved appearances at the cost of pavement ride quality. If good mixture proportioning, hauling, and placement practices are followed and if the paving equipment is properly set up and well maintained, hand finishing should be performed sparingly and only as necessary to correct significant pavement surface flaws and profile defects. The ACPA (2010) provides additional details concerning best practices for concrete pavement finishing.

Concrete pavement surface texture must be constructed to provide adequate surface friction (sustainability through safety and reduced crash rates, particularly in wet weather), while also minimizing the generation of noise through tire-pavement interaction. There are many concrete pavement surface texture options, including transversely oriented textures (e.g., transverse tining, brooming, and grooving), longitudinal textures (e.g., longitudinal tining, brooming, grooving, turf drag, diamond grinding, and NGCS), and textures with no particular orientation (e.g., porous concrete and exposed aggregate finishes). Details concerning the tire-pavement noise and friction characteristics of each of these surface types throughout the use phase of the pavement life cycle were discussed by Van Dam et al. (2015), ACPA (2006), and Henry (2000).

References

AASHTO PP 65-11 *Standard Practice for Determining the Reactivity of Concrete Aggregates and Selecting Appropriate Measures for Preventing Deleterious Expansion in New Concrete Construction*.

Adrian, W. and R. Jobanputra. 2005. Influence of Pavement Reflectance on Lighting for Parking Lots. Portland Cement Association, Skokie, IL.

https://www.greenconcrete.info/downloads/8_Influence_PavementReflectanceLightingParkingLotsSN2458.pdf

Akbari, H., L. Rose, and H. Taha. 1999. *Characterizing the Fabric of the Urban Environment: A Case Study of Sacramento, California*. Lawrence Berkeley National Laboratory, University of California, Berkeley, CA.

Akbari, H., S. Menon, and A. Rosenfeld. 2009. Global Cooling: Increasing World-Wide Urban Albedos to Offset CO₂. *Climatic Change*, Vol. 94, No. 3–4, pp. 275–286.

Akbari, H. and H. D. Matthews. 2012. Global Cooling Updates: Reflective Roofs and Pavements. *Energy and Buildings*, Vol. 55, pp. 2–6.

Akbarian, M., A. Louhghalam, and F. Ulm. 2015. *Analyzing Pavement-Vehicle Interaction through Bench-Top Experiments*. Research Brief, Issue 7. MIT Concrete Sustainability Hub, Massachusetts Institute of Technology, Cambridge, MA.

Alleman, J. and M. Heitzman. 2013. *Quantifying Pavement Albedo – Phase I Final Report: Literature Review and Detailed Work Plan*. National Concrete Pavement Technology Center (NCPTC) and National Center for Asphalt Technology (NCAT) for Federal Highway Administration, Turner-Fairbank Highway Research Center, McLean, VA.

ACPA. 2006. *Pavement Surface Characteristics: A Synthesis and Guide*. EB235P. American Concrete Pavement Association, Skokie, IL.

———. 2008. *Concrete Pavement Field Reference: Pre-Paving*. EB237P. American Concrete Pavement Association, Skokie, IL.

———. 2009. *Recycling Concrete Pavements*. EB043P. American Concrete Pavement Association, Skokie, IL.

———. 2010. *Concrete Pavement Field Reference: Paving*. EB238P. American Concrete Pavement Association, Rosemont, IL.

ASCE. 2010. *Structural Design of Interlocking Concrete Pavement for Municipal Streets and Roadways*. American Society of Civil Engineers, Reston, VA.

Antonucci, N. D., K. K. Hardy, J. E. Bryden, T. R. Neuman, R. Pfefer, and K. Slack. 2005. *NCHRP Report 500: Guidance for Implementation of the AASHTO Strategic Highway Safety Plan. Volume 17: A Guide for Reducing Work Zone Collisions*. National Cooperative Highway Research Program, Washington, DC.

Association of Environmental Professionals (AEP). 2012. *California Environmental Quality Act (CEQA) Statute and Guidelines*. Association of Environmental Professionals, Palm Desert, CA.

Brand, A., J. Roesler, I. Al-Qadi, and P. Shangguan. 2012. *Fractionated Reclaimed Asphalt Pavement (FRAP) as a Coarse Aggregate Replacement in a Ternary Blended Concrete Pavement*. Illinois Center for Transportation, University of Illinois at Urbana-Champaign, Urbana, IL.

Chai, L., C. L. Monismith, and J. Harvey. 2009. *Re-Cementation of Crushed Material in Pavement Bases*. California Department of Transportation, Sacramento, CA.

Chatti, K. and I. Zaabar. 2012. *NCHRP Report 720: Estimating the Effects of Pavement Condition on Vehicle Operating Costs*. National Cooperative Highway Research Program, Washington, DC.

Chupin, O., J. M. Piau, and A. Chabot. 2013. Evaluation of the Structure-Induced Rolling Resistance (SRR) for Pavements Including Viscoelastic Material Layers. *Materials and Structures*, Vol. 46, No. 4, pp. 683–696.

Cubasch, U., D. Wuebbles, D. Chen, M. C. Facchini, D. Frame, N. Mahowald, and J.-G. Winther. 2013. Introduction. In: *Climate Change 2013: The Physical Science Basis. Contribution of Working Group I to the Fifth Assessment Report of the Intergovernmental Panel on Climate Change*. Cambridge University Press, Cambridge, UK and New York, NY. pp. 119–158.

EPA. 2003. *Cooling Summertime Temperatures: Strategies to Reduce Urban Heat Islands*. U.S. Environmental Protection Agency, Washington, DC. <https://www.epa.gov/sites/production/files/2014-06/documents/hiribrochure.pdf>.

- . 2010. *Post-Construction Stormwater Management in New Development and Redevelopment*. U.S. Environmental Protection Agency, Washington, DC.
- . 2013. *Green Infrastructure Strategic Agenda 2013*. U.S. Environmental Protection Agency, Washington, DC. https://www.epa.gov/sites/production/files/2015-10/documents/2013_gi_final_agenda_101713.pdf.
- . 2015. *Inventory of U.S. Greenhouse Gas Emissions and Sinks: 1990-2013*. U.S. Environmental Protection Agency, Washington, DC. <https://www.epa.gov/ghgemissions/inventory-us-greenhouse-gas-emissions-and-sinks-1990-2013>.
- FEMA. 2007. *Extreme Heat*. Federal Emergency Management Agency, Washington, DC. https://www.fema.gov/media-library-data/20130726-1549-20490-2128/natural_hazards_2.pdf.
- FHWA. 2011. *Life-Cycle Cost Analysis Software*. Federal Highway Administration, Washington, DC. <https://www.fhwa.dot.gov/infrastructure/asstmgmt/lccasoft.cfm>.
- . 2012a. *INVEST*. Federal Highway Administration, Washington, DC. www.sustainablehighways.org.
- . 2012b. *Pervious Concrete*. Tech Brief. FHWA-HIF-13-006. Federal Highway Administration, Washington, DC. <https://www.fhwa.dot.gov/pavement/concrete/pubs/hif13006/hif13006.pdf>.
- . 2012c. *FHWA Lighting Handbook*. FHWA-SA-11-22. Federal Highway Administration, Washington, DC. https://safety.fhwa.dot.gov/roadway_dept/night_visib/lighting_handbook/.
- . 2018. *Sustainable Pavements Program*. Federal Highway Administration, Washington, DC. <http://www.fhwa.dot.gov/pavement/sustainability/>.
- Ferrebee, E. C. 2014. *Development of the Materials, Construction, and Maintenance Phases of a Life Cycle Assessment Tool for Pavements*. Master's Thesis. University of Illinois at Urbana-Champaign, Urbana, IL.
- Flugge, W. 1975. *Viscoelasticity*. Springer-Verlag Berlin Heidelberg New York. Springer, New York, NY.
- Gajda, J. and M. VanGeem. 2001. *A Comparison of Six Environmental Impacts of Portland Cement Concrete and Asphalt Cement Concrete Pavements*. Portland Cement Association, Skokie, IL. https://www.nrmca.org/taskforce/Item_4_TechnicalSupport/A%20Comparison%20of%20Six%20Environmental%20Impacts%20of%20Portland%20Cement%20Concrete%20and%20Asphalt%20Cement%20Concrete%20Pavements%20-%20SN2068.pdf.
- Henry, J. J. 2000. NCHRP Synthesis 291: *Evaluation of Pavement Friction Characteristics*. National Cooperative Highway Research Program, Washington, DC. http://onlinepubs.trb.org/onlinepubs/nchrp/nchrp_syn_291.pdf.
- Investopedia. 2018. *Opportunity Cost*. Investopedia, New York, NY. <http://www.investopedia.com/terms/o/opportunitycost.asp>.
- Jacobson, M. and J. Ten Hoeve. 2012. Effects of Urban Surfaces and White Roofs on Global and Regional Climate. *Journal of Climate*, Vol. 25, No. 3, pp. 1028–1044.
- Jones, P. D., P. Y. Groisman, M. Coughlan, N. Plummer, W. C. Wang, and T. R. Karl. 1990. Assessment of Urbanization Effects in Time Series of Surface Air Temperature Over Land. *Nature*, Vol. 347, No. 6289, pp. 169–172.
- Kosmatka, S. and M. Wilson. 2016. *Design and Control of Concrete Mixtures*. 16th Edition. Portland Cement Association. Skokie, IL.
- Lee, E. B., J. T. Harvey, and M. M. Samadian. 2005. Knowledge-Based Scheduling Analysis Software for Highway Rehabilitation and Reconstruction Projects. *Transportation Research Record: Journal of the Transportation Research Board*, No. 1907, pp. 15–24.
- Mack, J., F. Ulm, J. Gregory, R. Kirchain, M. Akbarian, O. Swei, and M. Wildnauer. 2013. Designing Sustainable Concrete Pavements Using the Pavement-ME Mechanistic Empirical Pavement Design and Life Cycle Analysis. Paper presented at the 2013 NRMCA International Concrete Sustainability Conference, May 6-8, San Francisco, CA. <https://cshub.mit.edu/sites/default/files/documents/mack-Sustainable-PCC-Pavements-2012.pdf>.

Menon, S., H. Akbari, S. Mahanama, I. Sednev, and R. Levinson. 2010. Radiative Forcing and Temperature Response to Changes in Urban Albedos and Associated CO₂ Offsets. *Environmental Research Letters*, Vol. 5, No. 1, pp. 1–11.

Millstein, D. and S. Menon. 2011. Regional Climate Consequences of Large-Scale Cool Roof and Photovoltaic Array Deployment. *Environmental Research Letters*, Vol. 6, No. 3, pp. 1–9.

Millstein, D. 2013. Cool Communities: Benefits of Cool Pavements in CA Cities. Paper presented at the 2013 NRMCA International Concrete Sustainability Conference, May 6-8, San Francisco, CA.

Minnesota Department of Transportation. 2010. *Mn/ DOT Roadway Lighting Design Manual*. Minnesota Department of Transportation, St. Paul, MN.

Morian, D., T. Van Dam, and R. Perera. 2012. *Use of Air-Cooled Blast Furnace Slag as Coarse Aggregate in Concrete Pavements*. FHWA-HIF-12-008. Federal Highway Administration. Washington, DC. <http://www.fhwa.dot.gov/pavement/concrete/pubs/hif12008.pdf>.

Muench, S. and T. Van Dam. 2014. *Pavement Sustainability*. Tech Brief. FHWA-HIF-14-012. Federal Highway Administration, Washington, DC. <https://www.fhwa.dot.gov/pavement/sustainability/hif14012.pdf>.

Navigant Consulting, Inc. 2010. *Assessment of International Urban Heat Island Research—Literature Review of International Studies on Urban Heat Island Countermeasures*. U.S. Department of Energy, Washington, DC.

Rangaraju, P. R., S. Amirkhanian, and Z. Guven. 2008. *Life Cycle Cost Analysis for Pavement Type Selection*. FHWA-SC-08-01. South Carolina Department of Transportation, Columbia, SC.

Rose, L., H. Akbari, and H. Taha. 2003. *Characterizing the Fabric of the Urban Environment: A Case Study of Metropolitan Houston, Texas*. Lawrence Berkeley National Laboratory, University of California, Berkeley, CA. <https://www.osti.gov/servlets/purl/816533>.

Rosenzweig, C., W. Solecki, L. Parshall, S. Gaffin, B. Lynn, R. Goldberg, J. Cox, and S. Hodges. 2006. Mitigating New York City’s Heat Island with Urban Forestry, Living Roofs, and Light Surfaces. Paper presented at the Sixth Symposium on the Urban Environment, January 27–February 3, Atlanta, GA. <https://www.giss.nasa.gov/research/news/20060130/103341.pdf>.

Santamouris, M. 2013. Using Cool Pavements as a Mitigation Strategy to Fight Urban Heat Island—A Review of the Actual Developments. *Renewable and Sustainable Energy Reviews*, Vol. 26, pp. 224–240.

Santero, N., E. Masanet, and A. Horvath. 2011. Life-Cycle Assessment of Pavements. Part I: Critical Review. *Resources, Conservation and Recycling*, Vol. 55, No. 9–10, pp. 801–809.

Santero, N., A. Loijos, and J. Ochsendorf. 2013. Greenhouse Gas Emissions Reduction Opportunities for Concrete Pavements. *Journal of Industrial Ecology*, Vol. 17, No. 6, pp. 859–868.

Smith, K. L., K. D. Smith, L. D. Evans, T. E. Hoerner, M. I. Darter, and J. H. Woodstrom. 1997. *NCHRP Web Document 1: Smoothness Specifications for Pavements*. National Cooperative Highway Research Program, Washington, DC.

Smith, D. R. 2011. *Permeable Interlocking Concrete Pavements Manual—Design, Specification, Construction, Maintenance*. Fourth Edition. Interlocking Concrete Pavement Institute, Chantilly, VA.

Smith, K. D., D. A. Morian, and T. J. Van Dam. 2012. *Use of Air-Cooled Blast Furnace Slag as Coarse Aggregate in Concrete Pavements—A Guide to Best Practice*. FHWA-HIF-12-009. Federal Highway Administration, Washington, DC.

Smith, R., E. Ferrebee, Y. Ouyang, and J. Roesler. 2014. Optimal Staging Area Locations and Material Recycling Strategies in Sustainable Highway Reconstruction. *Computer-Aided Civil and Infrastructure Engineering*, Vol. 29, pp. 559–571.

- Snyder, M., T. Van Dam, J. Roesler, and J. Harvey. 2016. *Strategies for Improving Sustainability of Concrete Pavement*. Tech Brief. FHWA-HIF-16-013. Federal Highway Administration. Washington, DC. <https://www.fhwa.dot.gov/pavement/sustainability/hif16013.pdf>.
- Sobstyl, J. 2013. Urban Physics: City Texture Matters. Paper presented at the 2013 NRMCA International Concrete Sustainability Conference, May 6–8, San Francisco, CA.
- Taha, H., S. Konopacki, and S. Gabersek. 1999. Impacts of Large-Scale Surface Modifications on Meteorological Conditions and Energy Use: A 10-Region Modeling Study. *Theoretical and Applied Climatology*, Vol. 62, No. 3–4, pp. 175–185.
- Tayabji, S. and S. Lim. 2007. *Long-Life Concrete Pavements: Best Practices and Directions from the States*. Tech Brief. FHWA-HIF-07-030. Federal Highway Administration. Washington, DC. <http://www.fhwa.dot.gov/pavement/concrete/pubs/07030/07030.pdf>.
- U.S. Department of Transportation. 2006. *National Strategy to Reduce Congestion on America's Transportation Network*. U.S. Department of Transportation (USDOT), Washington, DC.
- University of California Pavement Research Center. 2010. *Pavement Life Cycle Assessment Workshop*. Pavement Research Center (UCPRC), University of California, Berkeley and Davis, CA. <http://www.ucprc.ucdavis.edu/P-LCA/>.
- Van Dam, T. 2010. *Geopolymer Concrete*. Tech Brief. FHWA-HIF-10-014. Federal Highway Administration, Washington, DC. <https://www.fhwa.dot.gov/pavement/concrete/pubs/hif10014/hif10014.pdf>.
- Van Dam, T., J. Harvey, S. Muench, K. Smith, M. Snyder, I. Al-Qadi, H. Ozer, J. Meijer, P. Ram, J. Roesler, and A. Kenda. 2015. *Towards Sustainable Pavement Systems: A Reference Document*. FHWA-HIF-15-002. Federal Highway Administration, Washington, DC. <https://www.fhwa.dot.gov/pavement/sustainability/hif15002/hif15002.pdf>.
- Walls, J. and M. R. Smith. 1998. *Life-Cycle Cost Analysis in Pavement Design—Interim Bulletin*. FHWA-SA-98-079. Federal Highway Administration, Washington, DC. <https://www.fhwa.dot.gov/infrastructure/asstgmt/013017.pdf>.
- Wang, T., I. S. Lee, A. Kendall, J. Harvey, E. B. Lee, and C. Kim. 2012. Life Cycle Energy Consumption and GHG Emission from Pavement Rehabilitation with Different Rolling Resistance. *Journal of Cleaner Production*, Vol. 33, pp. 86–96.
- Wikipedia. 2018. Radiative Forcing. *Wikipedia, the Free Encyclopedia*. https://en.wikipedia.org/wiki/Radiative_forcing.
- World Commission on Environment and Development (WCED). 1987. *Our Common Future: The Report of the World Commission on Environment and Development*. Oxford University Press, University of Oxford, Oxford, UK.
- Xu, X., J. Gregory, and R. Kirchain. 2016. Climate Impacts of Surface Albedo: Review and Comparative Analysis. Paper presented at the Transportation Research Board 95th Annual Meeting, January 10–14, Washington, DC.

Chapter 3

Basics of Concrete Pavement Design

Integrated Pavement Design	30
Common Concrete Pavement Types	32
Design Considerations: What Do We Want?	33
Design Considerations: What Site Factors Do We Have to Accommodate?	41
Design Procedures: Getting What We Want for Given Site Factors	42
Constructability Issues	44
Concrete Overlays	46
References	49

Integrated Pavement Design

Key Points

- The objective of concrete pavement design is to select a pavement slab thickness and design details—such as joint dimensions, base considerations, drainage, load-transfer requirements, reinforcement, and so on—that will economically meet the traffic loading, soil, and climatic conditions of a specific paving project.
- Traditionally, concrete pavement design has focused on slab thickness. A more integrated approach to pavement design considers all elements of the pavement system that affect performance.
- The American Association of State Highway and Transportation Officials (AASHTO) *Mechanistic-Empirical Pavement Design Guide* (MEPDG) (AASHTO 2015) and accompanying AASHTOWare Pavement ME Design software incorporate an integrated approach to slab thickness determination.
- Most concrete pavements constructed today are jointed plain concrete pavement (JPCP) (unreinforced). These designs are generally cost-effective and reliable.
- Unjointed continuously reinforced concrete pavement (CRCP) designs, although more expensive to construct, may be warranted for certain high-traffic routes, such as some urban routes.

To integrate best materials and construction practices, it is important to understand the basics of concrete pavement design. This chapter provides an introduction to concrete pavement design that includes general materials and construction issues related to design, as well as some technological changes that allow the assumed design variables to relate more closely to as-built results.

The chapter begins with brief overviews of the philosophy of integrated pavement design and basic concrete pavement design types. It then discusses the elements of pavement design: first determining what we want;

then determining the specific site variables that must be accommodated; and, finally, providing direction on designing pavements that give us what we want in light of the variables. The chapter ends with a discussion of concrete overlay design.

Pavement design is the selection of slab thickness, joint dimensions, reinforcement and load-transfer requirements, and other pavement features. Figure 3-1 shows the basic features that must be determined when designing a traditional JPCP. Figure 3-2 shows the basic features that must be determined when designing a CRCP.

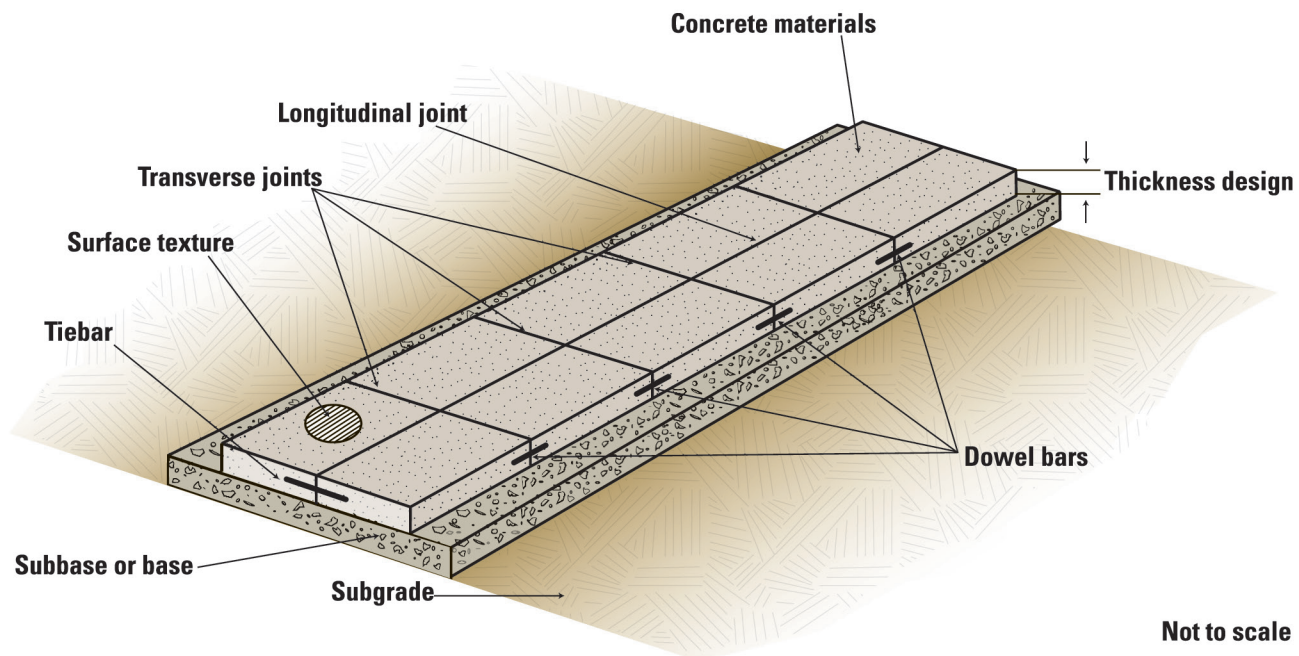

ACPA, used with permission

Figure 3-1. Design features of JPCP

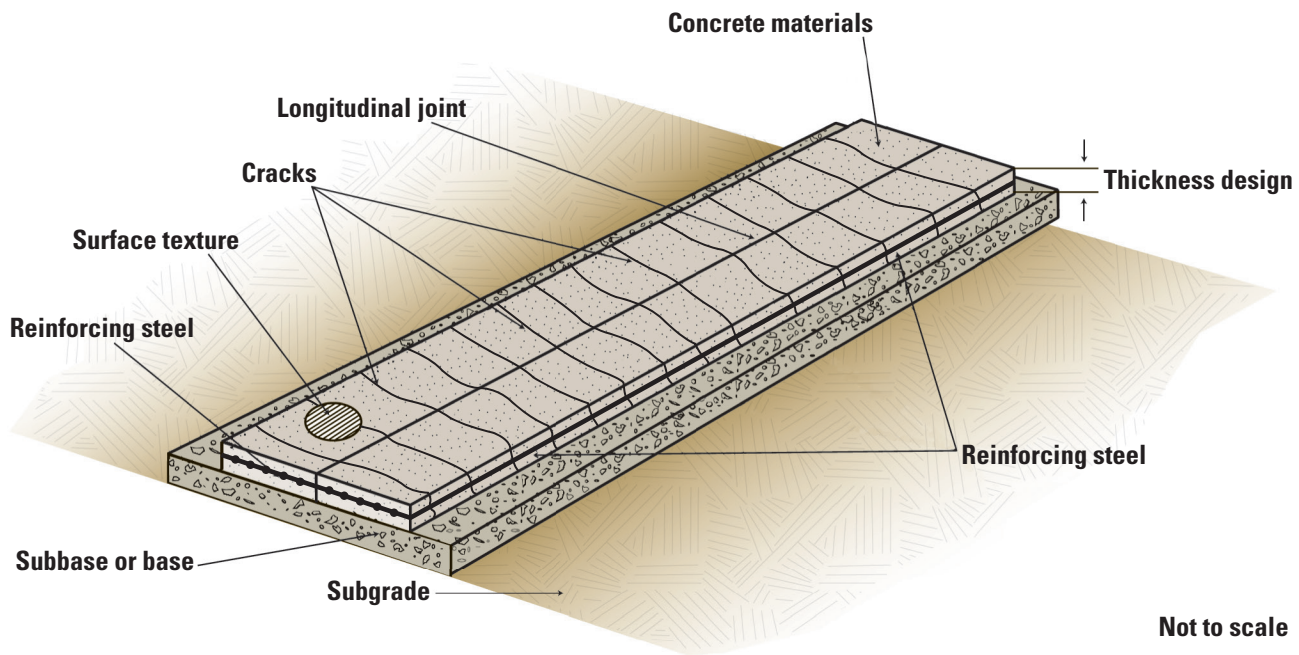

After ACPA

Figure 3-2. Design features of CRCP

Mechanistic-Empirical Design

During the design process, broad assumptions are often made about materials and construction issues that can have a significant impact on the performance of a specific pavement design. It is therefore critical to properly characterize materials through a rigorous testing regime that includes testing of proposed constituent materials, testing of concrete during the mixture proportioning process, and verification of concrete mixture properties during construction. In addition, subgrade and base construction activities should also be monitored. Such tests are important not only to ensure the quality of the materials used, but also to ensure that the actual concrete, base, and subgrade materials reflect the assumptions made during the pavement design process.

The focus of concrete pavement design has generally been on determining how thick the slab should be. Today, agencies are adopting a more integrated approach to pavement design. Such an approach simultaneously considers key pavement features, as well as durable concrete mixtures, constructability issues, etc., and is reflected in the long-life pavement concepts that have been adopted by many highway agencies. This integrated approach can also be observed in the thickness determination concepts incorporated into the MEPDG (AASHTO 2015).

More detailed information on concrete pavement design may be found in several sources (Yoder and Witzak 1975, Packard 1984, AASHTO 1993, AASHTO 1998, Smith and Hall 2001, ACI 2002, NCHRP 2004, AASHTO 2015).

Common Concrete Pavement Types

As mentioned previously, two concrete pavement design types are commonly used: JPCP and CRCP (Figure 3-3). Both design types can provide long-lasting pavements that meet or exceed specific project requirements. Both JPCP and CRCP are suitable for new construction, reconstruction, and unbonded overlays (resurfacing) of existing roads (see section on [Concrete Overlay Options](#) later in this chapter). Thin concrete pavements (TCP) are just now starting to be used in the US, mainly in commercial settings; although, they have been used internationally for many years.

JPCP - Jointed plain

Plan

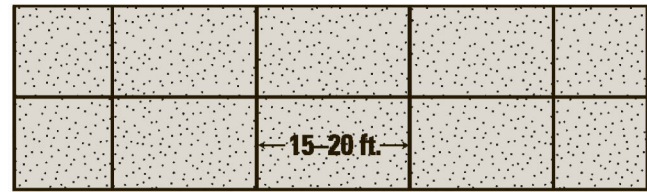

Profile

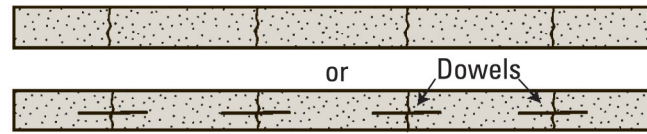

CRCP - Continuously reinforced

Plan

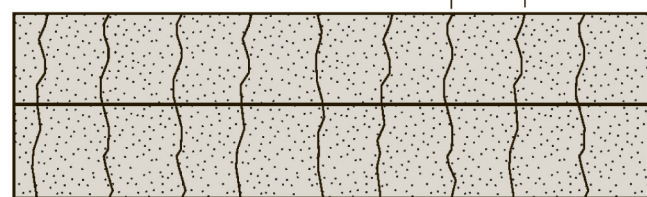

Profile



About 0.7% steel by area
 (No joints except at ends)

Not to scale

Adapted from ACPA

Figure 3-3. Concrete pavement types

Jointed Plain Concrete Pavement

Because of their cost-effectiveness and reliability, the vast majority of concrete pavements constructed today are JPCP designs. As the name implies, the slabs do not contain distributed reinforcement between the transverse joints, which are generally spaced 15 to 20 ft apart. They may contain dowel bars across the transverse joints to transfer heavy (e.g., trucks and buses) traffic loads across slabs and may contain tiebars across longitudinal joints to promote aggregate interlock between slabs.

Continuously Reinforced Concrete Pavement

CRCP is designed without transverse joints (transverse joints that do exist are either construction joints or terminal joints used to isolate the pavement from structures such as bridges; these require special attention). Instead, CRCP contains a significant amount of longitudinal reinforcement, typically 0.6 to 0.8 percent of the cross-sectional area of the slab. The high content of longitudinal reinforcement both influences the development of transverse cracks within an acceptable spacing (about 3 to 8 ft apart) and serves to hold cracks tightly together to maintain aggregate interlock for load transfer over the design life. Transverse reinforcement is also used to support the longitudinal steel during construction. Some agencies use CRCP designs for high-traffic urban routes because of their suitability for heavy traffic loads and long, relatively maintenance-free, service life.

Thin Concrete Pavement

In TCP design, the concrete pavement thickness is selected by optimizing the slab size to suit a given geometry of truck wheel and axle spacing, while considering environmental and support conditions. Slab size is configured so that not more than one set of wheels is on any given slab, thereby minimizing the critical tensile stress that develops in each slab (Covarrubias 2012). Typical thicknesses in TCP can be as low as 3 in. and up to 6 in., with common slab dimensions of 6×8 ft or 6×6 ft. The use of short slabs reduces curling stresses and helps maintain load transfer across the joints because each individual joint has little movement compared to joints in conventional JPCP with larger slab sizes. Because TCP is not currently in widespread use in the US, the remainder of this chapter will focus on JPCP and CRCP.

Design Considerations: What Do We Want?

Key Points

- For every concrete pavement project, the designer must define certain parameters:
 - Level of structural and functional performance
 - Target service life or design life
 - Levels of various concrete properties—strength, stiffness, dimensional stability, permeability, etc.—required (or tolerated) to achieve optimum performance for the design life
- Pavements must perform well structurally (i.e., carry imposed truck traffic loads) and functionally (i.e., provide safety and a comfortable, quiet ride). Performance is generally described in terms of structural and functional attributes.
- Concrete strength has traditionally been considered the most influential factor in design and is still a primary design input for determining slab thickness.
- Concrete stiffness and dimensional stability (thermal movement and drying shrinkage) influence performance, but until recently they have not traditionally been considered in design procedures.
- Concrete durability is a critical aspect of long-term pavement performance, but it is neither a “measurable” property nor a direct input in pavement structural design procedures (concrete durability is instead ensured through testing of constituent materials and measurement of related properties, such as permeability, as addressed through appropriate material and construction specifications).

For each specific pavement design, a designer defines the desired service life, pavement performance, and various concrete properties.

Service Life

Concrete pavements can be designed for virtually any service life, from as little as 10 years to 60 years or more. The primary factors in the design life are the quality of the materials selected and slab thickness, although other elements of design (e.g., slab geometry, drainage, shoulder support, and base support) may be equally or more important. Pavement mixtures with enhanced strength and durability characteristics, combined with enhanced structural design elements, are necessary for long-life concrete pavements (FHWA 2002).

Structural design methodologies assume that the mixtures will survive the environment to which they are exposed. Concrete mixtures specified for long-life pavements ideally contain high-quality, durable, and well-graded aggregate; a targeted air content for the environment in which the pavement will serve (6 to 8 percent entrained air with an ASTM C457 spacing factor of < 0.008 in. for increased freeze-thaw protection in severe freeze-thaw regions); an appropriate amount of supplementary cementitious materials (SCMs) such as slag cement or fly ash for reduced permeability and mitigation of alkali-silica reaction (ASR); and a w/cm ratio of 0.38 to 0.45 for severe environments. Concrete dimensional stability can be assessed through measurement of drying shrinkage (AASHTO T 160/ASTM C157) and the coefficient of thermal expansion (CTE) (AASHTO T 336). Another requirement may include a measure of the concrete's permeability based on electrical methods such as rapid chloride penetrability (AASHTO T 277/ASTM C1202) or surface resistivity (AASHTO T 358). Proper curing is also an important factor. The key to success is to understand the materials being used and the environment in which the concrete will serve and proportion the mixture accordingly.

Pavement Performance

The goal of all pavement design methods is to provide a pavement that performs well; that is, the goal is to provide a serviceable pavement over the design period for the given heavy traffic and environmental loadings. A pavement's desired performance is generally described in terms of structural and functional performance:

- Structural performance is a pavement's ability to carry the imposed traffic loads.

- Functional performance is a pavement's ability to provide users a safe, quiet, and comfortable ride for a specified range of speed.

Both structural and functional distresses are considered in assessing overall pavement performance or condition. Even well-designed and well-constructed pavements tend to degrade at an expected rate of deterioration as a function of the imposed loads and climate. Poorly designed pavements (even if they are well constructed) will likely experience accelerated deterioration (Figure 3-4).

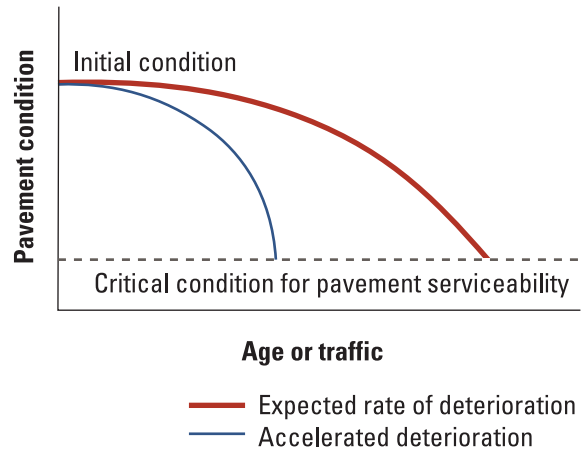

ACPA, used with permission

Figure 3-4. Pavement condition as a function of time or traffic

Durable concrete, obtained through proper selection of constituent materials, good mix design and proportioning, and proper construction practices, is necessary to achieve the expected level of pavement performance over the design life. Poor materials selection, mixture design/proportioning, and/or construction practices may significantly accelerate the development of structural and/or functional deterioration, leading to premature pavement failure.

Structural Performance

Structural performance is the ability of the pavement to support current and future heavy traffic loadings and to withstand environmental influences. Structural performance of concrete pavements is influenced by many factors, including design, material selection, and construction practices. The most influential design-related variables for structural performance at a given level of heavy traffic are slab thickness, reinforcement and load transfer, concrete strength, elastic modulus (characterization of the concrete's stiffness), and subgrade support conditions.

The most prevalent type of structural distress is load-related cracking, which may appear as corner cracking, transverse cracking, longitudinal cracking, or shattered slabs.

Corner Cracking

Corner cracking, or corner breaks, as shown in Figure 3-5, is usually caused by structural failure under loading, particularly due to repeated heavy loading, reduced edge support, and/or voids that have developed under slab corners due to the presence of moisture and/or pumping.



Figure 3-5. Corner cracking in jointed concrete pavement

Factors that contribute to corner cracking include excessive corner deflections from heavy traffic loads, inadequate load transfer across the joint, poor support conditions, curling and warping (see [Curling and Warping in Chapter 6](#)), insufficient slab thickness, inadequate curing, and/or inadequate concrete strength. It is critical that uniform support be provided to prevent excessive stresses resulting from varying support conditions at the corner. In addition, the slab is best able to distribute wheel loads at the center of the slab, rather than at the edges; therefore, longitudinal joints near or in the wheel track should be avoided. Corner cracking is not common when realistic truck traffic projections are used in the design and where effective, uniform base support, good drainage, and joint load transfer exist.

Transverse Cracking

Transverse cracking is a common type of structural distress in concrete pavements, but not all transverse cracks (also called mid-panel cracks) are indicative of structural failure. Moreover, many transverse cracks may have little or no impact on long-term performance. In general, cracks that do not separate and fault (i.e., undergo differential vertical movement or displacement) are not typically detrimental to pavement structural performance. The transverse cracking shown in Figure 3-6 is considered a structural distress because faulting is evident. Such cracking has significant structural implications because the dynamic loading from a rough pavement reduces structural life.



Kurt Smith

Figure 3-6. Structural transverse crack

Transverse cracking can be due to a number of factors, including excessive early-age loading, late joint sawing, locked up joints due to dowel bar misalignment, poor joint load transfer, inadequate or nonuniform base support, excessive slab curling and warping (see [Curling and Warping in Chapter 6](#)), insufficient slab thickness, inadequate sawing, and materials deficiencies.

Longitudinal Cracking

Longitudinal cracking may or may not be considered a structural distress, depending on whether the crack remains tight and nonworking. Figure 3-7 shows a longitudinal crack typical of poor support conditions. Note that the crack has significant separation and shows differential vertical movement, which indicates a structural distress.



Shiraz Tayabji

Figure 3-7. Structural longitudinal crack

Longitudinal cracking is generally associated with poor or nonuniform support conditions related to frost heave, moisture-induced shrinkage/swelling in the subgrade, or poor soil compaction. Longitudinal cracking may also result from inadequate placement of longitudinal joints, over-reinforcing of longitudinal joints, too-shallow joint saw cuts, or structural fatigue, particularly in thinner concrete slabs.

Shattered Slabs

Shattered slabs are those that are divided into three or more pieces by intersecting cracks (Figure 3-8). These working cracks allow for rapid differential settlement of the slab sections under loading.



Figure 3-8. Shattered slab

This type of distress can be attributed to numerous factors, the most important being heavy truck loading, inadequate slab thickness, and poor support.

Functional Performance

Most often, functional performance is thought to consist of surface friction (i.e., safety) and ride quality, although other factors such as noise and geometrics may also come into play. For pavement design, functional performance is generally considered through the change in ride quality over time. Ride quality is assessed through measurement of the pavement profile from which an index is calculated, such as the International Roughness Index (IRI). The IRI is one of the main pavement performance indicators used in the MEPDG (AASHTO 2015).

The functional performance of a concrete pavement is impacted by many of the same factors that contribute to structural performance, including concrete material selection, design, construction practices, and environmental conditions. Concrete pavement thickness design methods consider structural performance directly and functional performance only in terms of pavement smoothness and faulting. Additional functional distress types are generally considered through specifications governing items like surface friction characteristics and noise.

Some distresses, such as ASR and D-cracking, can arise from materials-related problems (see [Aggregate Durability in Chapter 4](#)). The cracking and spalling resulting from these distress types affect the functional characteristics of the pavement, including ride quality and safety, as well as impact the structural capacity of the pavement. However, distresses like ASR and D-cracking are not pavement design issues; they must be addressed through materials selection and mixture proportioning and verification (see [Adjusting Properties in Chapter 7](#)).

Surface friction is the most important functional characteristic of pavements. However, friction is not considered a pavement design element per se; in concrete pavements, it is instead addressed through the selection of abrasion-resistant aggregates that do not polish under traffic and texturing to establish macrotexture. Texture has implications with regard to noise generated through tire-pavement interaction.

Skid resistance increases with increasing texture, which is often separated into microtexture and macrotexture. The smaller microtexture is most closely related to the properties of the fine and coarse aggregate particles and how they microscopically fracture under the action of traffic. Aggregates that “polish” under traffic typically have fine-grain structures that become smooth, eventually resulting in a reduced microtexture (see [Abrasion Resistance in Chapter 6](#)). Aggregate specifications targeting minimum silica content in the fine aggregate or insoluble content in carbonate coarse aggregate are often used to address polishing.

For concrete pavements, the larger macrotexture is largely established by surface texturing. It has a significant impact on friction developed under wet conditions because the gaps between ridges provide channels for water to flow while the ridges grip and bend the tire tread. Surface texturing also significantly affects noise generated by tire-pavement interaction. Various texturing techniques are available to promote a macrotexture that provides good skid resistance while minimizing noise (see [Texturing in Chapter 8](#)).

Ride quality is considered a key indicator of functional performance and is affected by both initial construction and the occurrence of distress. Ride quality is generally assumed to equate to pavement smoothness, although this is not always the case. There are many methods to determine pavement smoothness, ranging from profilographs and profilometers that are appropriate for construction quality control (QC) to noncontact, high-speed inertial profilers that are useful for a network-level analysis.

Structural distress will almost always result in a reduction in functional performance because structural distresses generally reduce ride quality. Faulting is one example. Faulting results from a combination of inadequate load transfer at the joints, high corner deflections caused by heavy truck traffic loading, and inadequate, reduced, or erodible base support conditions.

Joint faulting is shown in Figure 3-9. Faulting is also possible where cracks have developed in the pavement, as described earlier. Faulted cracks have the same impact on the functional and structural performance of the pavement as faulted joints.



Figure 3-9. Faulting

Concrete Properties

Many concrete properties are critical to the performance of concrete pavements over the design life. Some of these properties are used as inputs to the pavement design process; others are assumed in determining concrete thickness or are not considered in the design process (see [Critical Properties of Concrete in Chapter 6](#)).

The most influential concrete properties for concrete performance include strength and stiffness, dimensional stability (drying shrinkage and thermal expansion), and properties related to durability, which are discussed in the following sections.

Concrete Strength

Concrete strength is a primary thickness design input in all pavement design procedures. Usually, flexural strength (also called the modulus of rupture [MOR]) is used in concrete pavement design because it characterizes the strength under the type of loading that the pavement will experience in the field (bending) (see [Strength and Strength Gain in Chapter 6](#)).

Flexural strength testing is conducted on a concrete beam under either center-point or third-point loading conditions. The third-point loading configuration, described under AASHTO T 97/ASTM C78, is more commonly used in pavement design and provides a more conservative estimate of the flexural strength than the center-point test.

Although flexural strength is specified in design, many state transportation agencies do not mandate the use of beam tests for monitoring concrete quality during construction. Instead, it is common to develop mixture-specific empirical correlations to other tests, such as compressive strength or split tensile strength, which are more convenient and less variable (Kosmatka and Wilson 2016). Each individual concrete mixture has its own empirical correlation of compressive strength to flexural strength. That is, the correlation is mixture specific, can vary from mixture to mixture, and should be established in laboratory testing during the mixture proportioning phase of the project. In general, the correlation can be approximated by the use of either of two equations (ACPA 2012, Raphael 1984):

$$MR = a \times \sqrt{f'_c} \quad (3.1)$$

$$MR = b \times f'_c^{(2/3)} \quad (3.2)$$

where:

MR = 28-day MOR (flexural strength), in pounds per square inch (lb/in²).

f'_c = 28-day compressive strength, lb/in².

a = coefficient ranging from 7.5 to 10 for lb/in² (coefficient must be determined for specific mixture).

b = 2.3 for lb/in² (exact coefficient must be determined for specific mix).

The more conservative equation should be used, depending on the range of values being used (Figure 3-10).

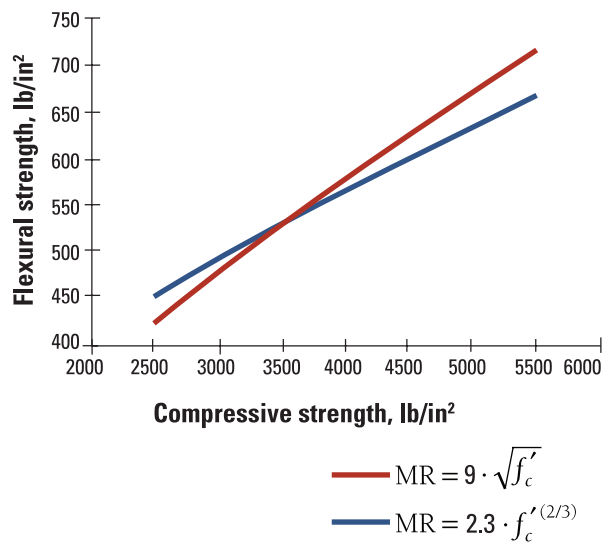

Figure 3-10. Comparison of compressive and flexural strength correlations, based on equations 3.1 and 3.2

The use of the maturity tests is becoming increasingly more common for assessing the in-place strength of concrete for opening the pavement to traffic (ASTM C1074, ACPA 2015). Maturity testing provides a reliable technique for continuously monitoring concrete strength gain during the first 72 hours. The technology offers several advantages over traditional testing methods, the most important being that it allows the pavement to be opened to traffic as soon as it has attained the necessary strength, without delay, whether or not it is a fast-track project (see Maturity Testing in Chapter 6).

Elastic Modulus (Stiffness)

Another concrete property important in pavement design is the elastic modulus, E, which typically ranges from 3 million to 6 million lb/in². The elastic modulus, or stiffness, of concrete is a measure of how much the material will deflect under load and strongly influences how the slab distributes loads. The determination of elastic modulus is described in ASTM C469. However, elastic modulus is often determined from the empirical formula related to compressive strength (ACI 2014):

$$E = 57,000 \times \sqrt{f'_c} \tag{3.3}$$

where:

$$E = 28\text{-day modulus elasticity (E), lb/in}^2$$

$$f'_c = 28\text{-day compressive strength, lb/in}^2$$

Drying Shrinkage and Thermal Expansion/Contraction

Concrete is affected by drying shrinkage and thermal expansion/contraction (see Shrinkage and Temperature Effects in Chapter 6). Drying shrinkage depends on a number of influential factors, including total water content, types and amounts of cementitious materials, w/cm ratio, coarse and fine aggregate types and quantities, and curing method. Total paste volume is being forwarded as a way to bring many of these factors together into a single variable (AASHTO PP 84). Thermal expansion/contraction is characterized through measurement of the concrete’s CTE (AASHTO T 336) and is most strongly influenced by the coarse aggregate.

Slab curling and warping (vertical translation in the slab due to differential temperatures and moisture contents, respectively) are functions of differential volume changes in the concrete. Excessive curling and warping have a substantial effect on long-term pavement performance in terms of cracking, faulting, and smoothness (see Curling and Warping in Chapter 6).

In the past, concrete volume changes were not a design input. However, volume changes play an important role in the MEPDG (AASHTO 2015). Accounting for drying shrinkage and thermal expansion/contraction properties in thickness design evaluation leads to better designs that optimize the slab thickness required for the design circumstances.

Joint spacing, another important element of concrete pavement design, should take into account potential volume changes of the concrete from temperature expansion/contraction and curling/warping. Reducing joint spacing typically controls curling and warping. Higher degrees of drying shrinkage and concrete CTE can be accommodated without increasing the risk of cracking problems.

Durability

Durable concrete is stable in its environment; that is, it experiences minimum deterioration due to freeze-thaw cycles, adverse chemical reactions between the concrete and its surroundings (for example, deicing chemicals), or internal reactions between the portland cement and aggregates (see the sidebar on Concrete Durability in Chapter 6).

Concrete durability is the most critical aspect of long-term pavement performance. However, durability is not a measurable concrete property, cannot be characterized by concrete strength, and is not a direct input in design procedures. Instead, durability is assumed in design and ensured through selection of quality materials and adherence to construction specifications. For example, freeze-thaw durability of the hydrated cement paste is primarily affected by the environment and the air-void system entrained in the concrete. ASR is controlled through specifications by prohibiting the use of aggregates that have been tested and found to be reactive, using an adequate amount of effective SCM or other additive to mitigate ASR if reactive aggregates are to be used, and/or by reducing the total alkali loading in the concrete below a specified level. D-cracking, related to freeze-thaw deterioration of certain coarse aggregates, can be controlled by testing aggregate sources and rejecting those that fail and/or reducing the maximum size of a susceptible coarse aggregate and blending it with a nonsusceptible aggregate.

A pavement designer must be aware of the potential impact of materials selection (made to improve durability) on structural and functional performance. Potential material selection impacts include the following:

- Small top-sized coarse aggregates, selected to delay D-cracking, will likely reduce load transfer at joints and cracks (critical for CRCP) and increase paste volume, thus increasing drying shrinkage.
- Air content targets (for freeze-thaw durability) that exceed 6 percent will likely decrease the concrete strength achieved, all other things held equal.
- Higher levels of strength used in design may increase paste content, increase shrinkage, decrease durability, and increase the risk of cracking.

Surface Texture: Balancing Friction and Noise

Work was conducted to find the optimum means of achieving satisfactory skid resistance while reducing noise effects at the tire/pavement interface (Rasmussen et al. 2011). Hall et al. (2009) provide information for defining methods for texturing concrete pavements to address specific climate, site, and traffic conditions; whereas, recent guidance is provided by Rasmussen et al. (2012) on practices for constructing and texturing concrete pavement surfaces to reduce noise.

Conventional Texturing Techniques

During construction, various tools or materials are dragged across the fresh concrete surface to produce a texture that enhances skid resistance. These tools and materials include moistened burlap, brooms, tining rakes, and artificial turf. Another technique to apply texture is diamond grinding the hardened concrete surface.

Diamond Grinding

Diamond grinding is a process that removes a thin layer of hardened concrete from the pavement surface using closely spaced diamond saw blades. Diamond grinding has traditionally been used during construction to achieve a desired level of smoothness (“bump grinds”) and to restore smoothness to an existing pavement that has become rough due to faulting and/or slab warping. It is becoming more common as an application for newly constructed concrete to provide a smooth, textured surface. The tight blade spacing in conventional diamond grinding results in closely spaced grooves with a “land area” between them created as the fin of concrete between the blades breaks off. An alternative diamond grinding surface, called the next-generation concrete surface (NGCS), combines grinding and grooving to significantly reduce noise from tire-pavement interaction while increasing friction (Figure 3-11).



Figure 3-11. Next-generation concrete surface (NGCS)

Drag Textures

Dragging artificial turf or moistened, coarse burlap across the surface of plastic concrete creates a shallow surface texture. This texturing method is inexpensive, results in relatively quiet pavements, and provides sufficient friction characteristics for many roadways, particularly those with speeds less than 45 mph. Iowa has found that drag textures can provide adequate friction on roadways with higher speeds when the concrete mixture includes adequate amounts of polishing-resistant (e.g., siliceous) sand (Cackler et al. 2006).

Longitudinal Tining

Longitudinally tined textures are created by moving a tining device (commonly a metal rake attached to a mechanical device) along the plastic concrete surface in the direction of paving. Longitudinal tining provides adequate friction on high-speed roadways while reducing tire-pavement noise associated with transverse tining (Hoerner and Smith 2002, ACPA 2002, Scofield 2013).

Recommendations for longitudinal tining include the following (FHWA 2005):

- A width of 0.1 in. ± 0.02 in. and a depth of 0.1 in. maximum are recommended. Narrower, deeper grooves are better than wider, shallower grooves, within the limits indicated, for minimizing noise.
- Straight, uniformly spaced grooves spaced at 0.7 in. have been shown to provide adequate handling characteristics for small vehicles and motorcycles.

Transverse Tining

Transversely tined textures are created by moving a tining device across the width of the plastic pavement surface. The tines can be uniformly or randomly spaced, or skewed at an angle.

Transverse tining is an inexpensive method for providing durable, high-friction pavement surfaces. The friction qualities are especially evident on wet pavements.

However, uniform transverse tining has been shown to exhibit undesirable noise due to tire-pavement interaction, creating an audible whine that is very annoying and should be avoided if possible.

Contrary to earlier studies, more recent observations have found that although randomly spaced and/or skewed transverse tining may reduce the audible whine while providing adequate friction, random and/or skewed transverse tining is not an adequate solution for reducing tire-pavement noise (Cackler et al. 2006).

Innovative Texturing Techniques

Exposed aggregate pavements and pervious pavements are being investigated for their friction and noise levels.

Exposed Aggregate

Texture is created through exposed aggregate on a pavement surface via a two-layer, “wet on wet” paving process. A thin layer of concrete containing fine siliceous sand and high-quality coarse aggregate is placed over a thicker layer of more modest durability. A set-retarding agent is applied to the newly placed top layer. After 24 hours, the surface mortar is brushed or washed away, exposing the durable aggregates.

When designed and constructed properly, these pavements have been reported to improve friction and durability while reducing noise.

In Europe, exposed aggregate pavements are regarded as one of the most advantageous methods for reducing tire-pavement noise while providing adequate friction. Smaller aggregate sizes have been reported to provide larger noise reductions, while aggregates with a high resistance to polishing increase durability. In trial projects in North America, however, reported noise levels on exposed aggregate surfaces have not been low.

Pervious Concrete

Pervious concrete has large voids intentionally built into the concrete mixture, allowing water and air to flow through the pavement. In addition to providing thorough surface drainage, the voids tend to absorb tire-pavement noise. The sound absorption levels of pervious concrete pavements have been shown to increase with higher porosity levels and smaller aggregate sizes.

Design Considerations: What Site Factors Do We Have to Accommodate?

Key Points

- Concrete pavements need adequate, well-draining, uniform subgrade/base support. Uniformity is especially important.
- Environmental factors can have a significant effect on pavement performance. The design procedure in the MEPDG attempts to incorporate important environmental factors.
- Truck and other heavy traffic data, particularly regarding the anticipated number of trucks, axle types, and loads, are major factors in pavement design.

Site-specific factors unique to the location of a particular paving project that significantly affect its design and performance include subgrade support conditions, environmental forces, and anticipated truck and heavy traffic loadings.

Subgrade Support

Concrete pavements distribute wheel loading to the subgrade over a large area through the bending action of the slab. Poor or nonuniform support under the slab, or degradation of support with time, leads to cracking and failure. Concrete pavements do not require as much support as other pavement materials, thus reducing the extent of necessary base preparation, but they do require relatively uniform support over their service life for good long-term performance.

In concrete pavement design, subgrade support is characterized by the modulus of subgrade reaction (k). The k can be determined through a plate load test, back-calculation of deflection data, or correlation to other readily determined soil parameters.

The support value used in design generally represents a seasonally adjusted average over the design life of the project. It is assumed that the support is nonerodible and relatively constant.

Environmental Factors

Environmental factors, such as precipitation and temperatures, can significantly affect pavement performance. Generally, pavements exposed to severe climates (e.g., higher rainfall or more freeze-thaw cycling) may not perform as well as pavements in moderate climates. Pavements in similar climatic regions or exposed to similar climatic forces should perform in a similar manner if similar materials, proportions, and construction practices are followed.

Most empirical-based design procedures do not incorporate environmental factors or may consider only a few of them indirectly. The MEPDG, through the use of the enhanced integrated climatic model (EICM), predicts changes in temperature and moisture profiles through the pavement structure (i.e., surface to subgrade) over time. For concrete pavements, the EICM is used to determine concrete thermal gradients, slab curvature, moisture warping, joint and crack opening/closing, temperature effects on asphalt base modulus, freezing index, and number of freeze-thaw cycles.

Daily and seasonal environmental variations can influence the behavior of concrete pavement in the following ways (Smith and Hall 2001):

- Opening and closing of transverse joints in response to daily and seasonal variation in slab temperature, resulting in fluctuations in joint load-transfer capability
- Upward and downward curling of the slab due to daily cycling of the temperature gradient through the slab thickness ([see Curling and Warping in Chapter 6](#))
- Upward warping of the slab due to the moisture gradient (drier on top than the bottom) through the slab thickness
- Erosion of base and foundation materials due to inadequate drainage
- Freeze-thaw weakening of subgrade soils
- Freeze-thaw damage to some coarse aggregates
- Corrosion of steel, especially in coastal environments and in areas where deicing salts are used

Truck and Heavy Traffic Considerations

The number, weight, and configuration of trucks and other heavy vehicles that are anticipated to use the roadway over its design life represent a major factor in pavement design. Of particular interest is the number of trucks and the axle loads (axle type, axle weight, number of axles, and axle spacing). For urban applications, buses can make up a significant percentage of the heavy traffic loading, and in some applications such as bus corridors, they may be the dominant source of traffic loading.

Design Procedures: Getting What We Want for Given Site Factors

Key Points

- The MEPDG, which uses ME design principles, is replacing the 1993 AASHTO design procedure.
- Mechanistic-empirical design combines mechanistic principles (stress/strain/deflection analysis and resulting damage accumulation) and empirical data for real-world validation and calibration.
- The validity of any pavement design procedure is only as good as the data used as inputs and the values used for local conditions in the models.
- In a constructability review process (CRP), designers partner with construction personnel who have extensive construction knowledge early in the design process to ensure that a project is buildable, cost effective, biddable, and maintainable. In addition, many agencies are developing a CRP for the early stages of concrete pavement design to help ensure project success.

Mechanistic-Empirical Design Procedure

Although several state highway agencies are still using the 1993 (or earlier) AASHTO pavement design procedure, the majority of agencies have either implemented or are in the process of implementing the MEPDG in the next several years (Pierce and McGovern 2014).

The MEPDG, and the companion AASHTOWare Pavement ME Design software, are available through AASHTO. The MEPDG was developed in an effort to improve the basic pavement design process (NCHRP 2004).

The MEPDG procedure must be verified and, if necessary, locally calibrated so that the pavement performance prediction models reflect local conditions. The validity of any pavement design is only as good as the data used as inputs and the prediction capability of the pavement performance models.

ME design procedures combine mechanistic principles (calculation of stress, strain, deflection, and resulting damage accumulation) with field performance verification and calibration. The MEPDG is considered to be a more scientifically based approach to pavement design than the previous AASHTO pavement design procedures, incorporating many new aspects of pavement design and performance prediction.

The MEPDG is based on the accumulation of incremental damage, in which a load is placed on the pavement at a critical location, the resulting stresses/strains and deflections are calculated, the damage due to the load is assessed, and finally a transfer function is used to estimate the distress resulting from the load. A similar procedure is followed for each load (based on axle load spectra) under the conditions existing in the pavement at the time of load application (considering load transfer, uniformity and level of support, curling and warping, concrete material properties, and so on). The final step is to sum all of the distresses that accumulate in the pavement as a function of time or heavy traffic.

One benefit of the MEPDG is that it predicts specific distress types as a function of time or heavy traffic applications. Cracking, faulting, and changes in smoothness (based on the IRI) are estimated. Threshold values for each distress type are inputted by the designer based on experience, policy, or risk tolerance.

MEPDG Input Parameters

The MEPDG (AASHTO 2015) is based on the process of adjusting factors that can be controlled during construction in order to accommodate factors that we cannot control (e.g., climate) and to achieve the parameters and performance that we want.

1. What do we want?

The MEPDG is able to model the performance of the following concrete pavement types. The performance models use inputs from items 2 and 3 below to predict pavement performance at the end of the selected design life. If the results are unacceptable, the parameters can be adjusted and the analysis can be rerun until the desired performance is obtained.

- JPCP
 - Acceptable surface roughness (i.e., IRI) at the end of the life
 - Acceptable transverse cracking at the end of the life
 - Acceptable faulting at the end of the life
- CRCP
 - Acceptable surface roughness (i.e., IRI) at the end of the life
 - Acceptable number of punchouts at the end of the life

2. What do we have to accommodate?

These are parameters that vary from location to location and cannot be changed, but they must be accounted for in the modeling.

- Expected heavy traffic loading
 - Type of truck (and bus, if applicable) traffic (classes)
 - Growth of heavy traffic density with time
- Climate in which the pavement is built
- Subgrade soils
- Water table depth

3. What can we adjust?

These are the parameters that can be adjusted in the design process in order to achieve the properties and performance required in item 1:

- Pavement type (JPCP or CRCP)
- JPCP joint details (dowel diameter, dowel spacing, joint spacing, and sealant type)
- CRCP design details (percent steel, bar diameter, steel depth, and crack spacing)
- Edge support (widened slab and tied shoulders)
- Erodibility index (nonerrodible to very errodible)
- Portland cement concrete (PCC)-base contact friction
- Permanent curl/warp effective temperature difference
- Layer 1: Concrete properties
 - Thickness
 - Mix (cement type, cementitious content, water to cement ratio, zero-stress temperature, ultimate shrinkage, reversible shrinkage, time to develop 50 percent of ultimate shrinkage, and curing method)
 - Strength (modulus of rupture, compressive strength, and modulus of elasticity)
 - Thermal properties (coefficient of thermal expansion, conductivity, and heat capacity)
 - Unit weight
 - Poisson’s ratio
- Layer 2: Stabilized layer properties
 - Material type (flexible or chemical)
 - Thickness
 - Poisson’s ratio
 - Unit weight
 - Flexible
 - Mixture volumetrics (air voids and effective binder content)
 - Mechanical properties (asphalt binder type, creep compliance, dynamic modulus, indirect tensile strength, and reference temperature)
 - Thermal properties (heat capacity, conductivity, and contraction)
- Chemical (cement, lime-cement-fly ash, lime-fly ash, lime, and soil-cement)
 - Strength (resilient modulus)
 - Thermal properties (heat capacity and conductivity)

- Layer 3: Nonstabilized layer properties
 - Thickness
 - Coefficient of lateral earth pressure
 - Poisson’s ratio
 - Strength (resilient modulus)
 - Thermal (conductivity and heat capacity)
 - Gradation
- Layer 4: Soil properties
 - Type (soils classification)
 - Coefficient of lateral earth pressure
 - Strength (resilient modulus)
 - Gradation

Other Design Tools

PavementDesigner.org is an online resource provided by the ACPA, the Ready Mixed Concrete (RMC) Research & Education Foundation, and the Portland Cement Association (PCA) that combines current versions of ACPA’s StreetPave, AirPave, and WinPAS programs with PCA’s PCAPave program. The portal provides design guidance, substructure sensitivity, and asphalt design evaluation capabilities. It is intended to be used by city, county, and consultant engineers and addresses full-depth concrete, concrete overlays and composite pavements, roller-compacted concrete, cement-treated bases, and full-depth reclamation with cement.

Constructability Issues

Constructability refers to the feasibility of constructing the proposed pavement design, including the materials, construction, and maintenance aspects. It is the assurance that the pavement design can be capably constructed using available materials and methods and then effectively maintained over its service life.

To help ensure the success of their construction projects, many agencies are exploring development of a CRP. As defined by the AASHTO Subcommittee on Construction, constructability review is “a process that utilizes construction personnel with extensive construction knowledge early in the design stages of projects to ensure that the projects are buildable, while also being cost-effective, biddable, and maintainable” (AASHTO 2000).

Implementing a CRP is expected to offer the following advantages (AASHTO 2000):

- Enhance early planning
- Minimize scope changes
- Reduce design-related change orders
- Improve contractor productivity
- Develop construction-friendly specifications
- Enhance quality
- Reduce delays
- Improve public image
- Promote public/work zone safety
- Reduce conflicts, disputes, and claims
- Decrease construction and maintenance costs

Constructability issues are involved in all aspects of the concrete pavement design and construction process. Furthermore, the issues can range from very general to very detailed. Some constructability issues in the concrete pavement design and construction process at the broadest level include the following:

- Mix design
- Pavement design
- Construction
- Curing and opening to traffic
- Maintenance

Mix Design

Are quality materials available for the proposed mix design? Does the proposed mix design provide the required properties (workability, durability, and strength) for the proposed application? What special curing requirements may be needed for the mix?

Pavement Design

What design procedure was used in developing the slab thickness design? Was an alternative design procedure used for verification? Have the individual design elements been developed as a part of the entire pavement system? Has an effective jointing plan been developed for intersections or other complex locations?

Construction

Are competent contractors available to do the work? Do the properties of the base and subgrade materials meet the design assumptions? Does the design have any unique construction requirements? What are the duration of construction and the anticipated weather conditions? Is there an extreme weather management plan in place? Are contractors familiar with hot-weather (ACI 2010a) and cold-weather (ACI 2010b) concrete construction? Are safeguards in place to prevent rain damage during construction? Are safeguards in place to prevent damage from early freezing during construction? What curing is required? How will traffic be maintained or controlled during construction?

Curing and Opening to Traffic

What curing is required for the mix design in order to meet opening requirements? What systems are in place to monitor strength gain? What protocols are in place to deal with adverse environmental changes or conditions?

Maintenance

Is the design maintainable? Are there features that may create maintenance problems in the future? Should a longer-life design be contemplated to minimize traffic disruptions for future maintenance and rehabilitation activities?

Again, these represent very general items; many more detailed items may be added to the review process. Various levels and frequencies of constructability reviews can be conducted, depending on the scope and complexity of the project. More detailed information on constructability reviews is available from the National Cooperative Highway Research Program (Anderson and Fisher 1997) and AASHTO (2000).

Concrete Overlays

Key Points

- Concrete overlays are used as maintenance and rehabilitation techniques on existing concrete, asphalt, and composite (asphalt on concrete) pavements.
- The most important aspect of concrete overlay design is the interface with the existing pavement.
- Concrete overlays include bonded concrete overlays and unbonded concrete overlays, ranging in thickness from 2 to 10 in.
- If an existing concrete pavement is cracked and is to have a bonded overlay, the crack needs to be repaired or it will reflect through the overlay. If the overlay is unbonded, a separation layer prevents the cracks from reflecting up through the new layer.
- For overlays over asphalt, any cracks in the asphalt normally will not reflect through the overlay.
- If the existing pavement suffers from materials-related distress, it may not be a good candidate for an overlay.

Concrete overlays are being used more often as maintenance and rehabilitation techniques on existing concrete and asphalt pavements. Concrete overlays can serve as cost-effective maintenance and rehabilitation solutions for almost any combination of existing pavement type and condition, desired service life, and anticipated traffic loading (Harrington and Fick 2014). Across the country, at least one type of concrete overlay has been used to maintain or rehabilitate aging pavements in every state. Concrete overlays offer many important benefits, including extended service life, increased load-carrying capacity, accelerated construction times, limited maintenance requirements, and reduced life-cycle costs.

Concrete Overlay Options

Concrete overlays are classified according to the existing pavement type and the bonding condition between layers (Smith et al. 2002). Concrete overlays form two families: bonded concrete overlays and unbonded concrete overlays (Figure 3-12 and Figure 3-13).

Bonded Concrete Overlays on Concrete Pavements

—previously called bonded overlay—

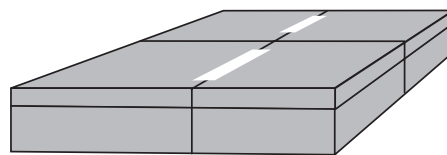

Bonded Concrete Overlays on Asphalt Pavements

—previously called ultra-thin whitetopping—

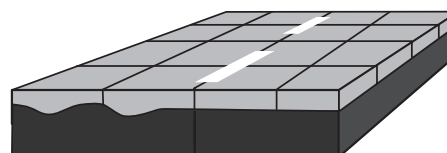

Bonded Concrete Overlays on Composite Pavements

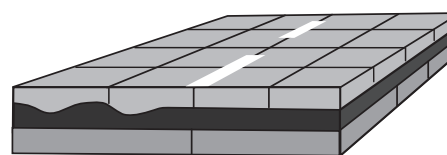
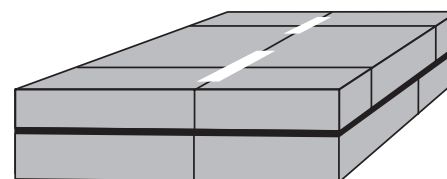

Figure 3-12. Examples of bonded overlays

Unbonded Concrete Overlays on Concrete Pavements

—previously called unbonded overlay—



Unbonded Concrete Overlays on Asphalt Pavements

—previously called conventional whitetopping—

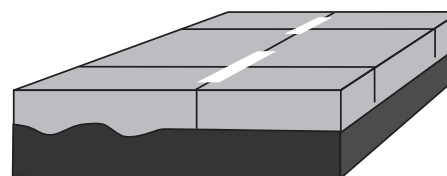

Unbonded Concrete Overlays on Composite Pavements

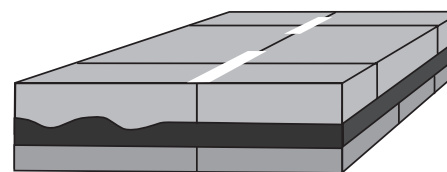

Figure 3-13. Examples of unbonded overlays

Bonded concrete overlays are bonded to an existing pavement, creating a monolithic structure. The purpose of bonded concrete overlays is to improve structural capacity and eliminate existing surface distress (Harrington and Fick 2014). Bonded concrete overlays require that the existing concrete pavement be in good structural condition and the existing asphalt pavement be in fair condition.

Unbonded concrete overlays add structural capacity to the existing pavement. Constructed essentially as new pavements on a stable base, unbonded overlay projects do not require bonding between the overlay and the underlying pavement.

Both bonded and unbonded overlays can be placed on existing concrete pavements, asphalt pavements, or composite pavements (original concrete pavements that have been resurfaced previously with asphalt). For more information on concrete overlays, see Harrington and Fick (2014).

Concrete Overlays on Concrete Pavements

Bonded Concrete Overlays on Concrete Pavements

A bonded concrete overlay on concrete is a thin concrete surface layer (typically 2 to 5 in. thick) that is bonded to an existing concrete pavement. Bonded overlays are used to increase the structural capacity of an existing concrete pavement or to improve its overall ride quality, skid resistance, and reflectivity.

Bonded overlays should be used only where the underlying pavement is free of structural distress and in relatively good condition, without existing cracks that will reflect through the new layer. To perform well, the joints should be aligned with joints in the underlying pavement. Matched joints help eliminate reflective cracking and ensure that the two layers of the pavement structure move together.

Unbonded Concrete Overlays on Concrete Pavements

Unbonded overlays on concrete contain a separation layer between the existing concrete pavement and the new concrete surface layer. The separation layer prevents mechanical interlocking of the new pavement with the existing pavement, so both are free to move independently. The separation layer has traditionally been 1 in. of hot mix asphalt placed to provide a shear plane that helps prevent cracks from reflecting up from the existing pavement into the new overlay. Recently, thick geotextile fabrics have been used with great success as a separation layer (Cackler et al. 2018).

Unbonded concrete overlays are typically constructed about 6 to 11 in. thick. Because of the separation layer, they can be placed on concrete pavements in practically any condition, although areas that will not provide adequate support to the overlay should be removed and replaced. Overlays on pavements in advanced stages of deterioration or with significant materials-related problems (such as D-cracking or ASR) should be considered cautiously because expansive materials-related distresses can cause cracking in the new overlay.

Some highway agencies specify that joints in unbonded concrete overlays should be mismatched with those in the underlying pavement to maximize the benefits of load transfer. However, many agencies do not intentionally mismatch joints and have not experienced any adverse effects.

Concrete Overlays on Asphalt Pavements

Bonded Concrete Overlays on Asphalt Pavements

Bonded concrete overlays on asphalt (BCOA) may be used as a maintenance or resurfacing technique on existing asphalt pavements. These thin treatments have been used most often on state highways and secondary routes.

BCOA pavements typically involve the placement of a 4 to 6 in. concrete layer on an existing asphalt pavement. The existing asphalt pavement may be milled, but this is not necessary, and at least 3 in. of asphalt should remain after milling to ensure adequate load carrying capacity from the asphalt pavement. Small square slabs are also used (typically from 3 to 8 ft) to reduce the overall thermal movement of each panel so the concrete does not separate from the asphalt and to reduce curling and warping stresses (see *Curling and Warping in Chapter 6*).

Unbonded Concrete Overlays on Asphalt Pavements

Unbonded concrete overlays on asphalt are often placed on existing distressed asphalt pavements. This type of overlay is generally designed as a new concrete pavement structure and constructed 6 to 11 in. thick. Bonding between the concrete overlay and hot mix asphalt pavement is not purposely sought or relied on as part of the design procedure. Some bonding may increase the effective thickness through composite action. It is not necessary to try to prevent bonding for these types of overlays since the concrete will dominate in its movement and thus can separate from the underlying asphalt. The jointing pattern of the overlay is similar to normal concrete.

Concrete Overlays on Composite Pavements

Concrete overlays on composite pavements follow many of the same principles as concrete overlays on concrete and asphalt pavements.

Mechanistic-Empirical Concrete Overlay Thickness Design

The MEPDG also provides a means to design selective concrete pavement overlays, integrating materials and environmental factors. The design of concrete overlays has always been a pavement design option within the MEPDG. However, the July 2016 release of AASHTOWare Pavement ME Design included an option for designing thin (less than 6 in.) bonded concrete overlays of asphalt pavements.

The AASHTOWare Pavement ME Design incorporates the bonded concrete overlay of asphalt pavements ME design (BCOA-ME) process developed by Julie Vandenbossche, University of Pittsburg (Vandenbossche 2016). Within the AASHTOWare Pavement ME Design software, this process is referred to as short JPCP overlay of asphalt concrete pavements (SJPCP/AC).

Many of the inputs for concrete overlay thickness design are the same as those previously described in MEPDG Input Parameters. Therefore, this section will focus on the unique features specific to concrete overlays.

1. What do we want?

The MEPDG can evaluate and design the following concrete overlay pavement types. As with new construction, if the predicted performance results are unacceptable, the parameters that can be changed are adjusted and the analysis is rerun to determine if the anticipated performance is obtained.

- Unbonded JPCP overlay over existing asphalt pavement, JPCP, and CRCP
 - Acceptable surface roughness at the end of the life
 - Acceptable transverse cracking at the end of the life
 - Acceptable faulting at the end of the life
- Unbonded CRCP overlay over existing asphalt pavement, JPCP, and CRCP
 - Acceptable surface roughness at the end of the life
 - Acceptable number of punchouts at the end of the life

- Bonded JPCP over asphalt pavement and JPCP
 - Acceptable surface roughness at the end of the life
 - Acceptable transverse cracking at the end of the life
 - Acceptable faulting at the end of the life
- Bonded CRCP over asphalt pavement and CRCP
 - Acceptable surface roughness at the end of the life
 - Acceptable number of punchouts at the end of the life

2. What do we have to accommodate?

This is the same as with new construction.

3. What can we adjust?

This is the same as with new construction, with the following additions:

- Assess the condition of existing pavement (e.g., slabs distressed/replaced before restoration and asphalt milled thickness)
- SJPCP/AC analysis can evaluate the following joint spacing in feet: 2×2, 3×3, 4×4, 6×6, 7×7, 10×12, 12×12, and 15×12

A number of design methods are available specifically for the design of BCOA, with the most popular being BCOA-ME (http://www.engineering.pitt.edu/Sub-Sites/Faculty-Subsites/J_Vandenbossche/BCOA-ME/BCOA-ME-Design-Guide/).

Additional Design Considerations

Some of the important aspects of overlay design are the condition of the underlying pavement, traffic loading, and the type of climatic conditions the overlay will be in.

Conventional concrete paving mixtures may be used for concrete overlays.

Some concrete overlays (particularly the thinner ones) require additional materials considerations:

- For bonded concrete overlays on concrete pavements, it is important to match the thermal expansion/contraction effects of the overlay concrete material to the existing concrete substrate (pavement). If two concrete layers with vastly different coefficients of thermal expansion are bonded, the bond line will be stressed during cycles of temperature change.

Materials with similar temperature sensitivity will expand and contract similarly at the interface. Thermal expansion/contraction problems generally result from different types of coarse aggregate in the original concrete slab and the concrete overlay (see [Thermal Expansion/Contraction in Chapter 6](#)). (This is not an important consideration when placing a concrete overlay on asphalt.)

- For BCOA pavements, including fibers in the overlay concrete mixture (see [Materials for Dowel Bars, Tiebars, and Reinforcement in Chapter 4](#)) can help control plastic shrinkage cracking and provide post-cracking integrity (Smith et al. 2002, Harrington and Fick 2014).

A few additional issues need to be considered specific to the preparation for and construction of concrete overlays.

References

AASHTO PP 84-18 *Standard Practice for Developing Performance Engineered Concrete Pavement Mixtures*.

AASHTO T 97 *Standard Method of Test for Flexural Strength of Concrete (Using Simple Beam with Third Point Loading)*.

AASHTO T 160 *Standard Method of Test for Length Change of Hardened Hydraulic Cement Mortar and Concrete*.

AASHTO T 277 *Electrical Indication of Concrete's Ability to Resist Chloride Ion Penetration*.

AASHTO T 336 *Standard Method of Test for Coefficient of Thermal Expansion of Hydraulic Cement Concrete*.

AASHTO T 358 *Standard Method of Test for Surface Resistivity Indication of Concrete's Ability to Resist Chloride Ion Penetration*.

ASTM C78 *Standard Test Method for Flexural Strength of Concrete (Using Simple Beam with Third-Point Loading)*.

ASTM C157M-04 *Standard Test Method for Length Change of Hardened Hydraulic Cement, Mortar, and Concrete*.

ASTM C457 *Standard Test Method for Microscopical Determination of Parameters of the Air-Void System in Hardened Concrete*.

ASTM C469 *Standard Test Method for Static Modulus of Elasticity and Poisson's Ratio of Concrete in Compression*.

ASTM C1074 *Standard Practice for Estimating Concrete Strength by the Maturity Method*.

ASTM C1202 *Standard Test Method for Electrical Indication of Concrete's Ability to Resist Chloride Ion Penetration*.

AASHTO. 1993. *AASHTO Guide for Design of Pavement Structures*. American Association of State Highway and Transportation Officials, Washington, DC.

AASHTO. 1998. *Supplement to the AASHTO Guide for Design of Pavement Structures, Part II—Rigid Pavement Design and Rigid Pavement Joint Design*. American Association of State Highway and Transportation Officials, Washington, DC.

AASHTO. 2000. *Constructability Review Best Practices Guide*. Subcommittee on Construction, American Association of State Highway and Transportation Officials, Washington, DC.

AASHTO. 2015. *Mechanistic-Empirical Pavement Design Guide: A Manual of Practice*. Second Edition. American Association of State Highway and Transportation Officials, Washington, DC.

ACI. 2002. *Guide for Design of Jointed Concrete Pavements for Streets and Local Roads*. ACI 325.12R-02. American Concrete Institute, Farmington Hills, MI.

———. 2010a. *Guide to Hot Weather Concreting*. ACI 305R-10. American Concrete Institute, Farmington Hills, MI.

———. 2010b. *Guide to Cold Weather Concreting*. ACI 306R-10. American Concrete Institute, Farmington Hills, MI.

———. 2014. *Building Code Requirements for Structural Concrete and Commentary*. ACI 318-14. American Concrete Institute, Farmington Hills, MI.

———. 2002. *Longitudinal Texture for Smooth Quiet Ride. Concrete Pavement Findings*. American Concrete Pavement Association, Skokie, IL.

ACPA. 2012. *WinPAS Pavement Analysis Software User Guide*. American Concrete Pavement Association, Skokie, IL.

———. 2015. *Maturity Testing*. American Concrete Pavement Association, Skokie, IL. http://wikipave.org/index.php?title=Maturity_Testing.

Anderson, S. D. and D. J. Fisher. 1997. *NCHRP Report 391: Constructibility Review Process for Transportation Facilities*. National Cooperative Highway Research Program, Washington, DC.

ARA, Inc., ERES Consultants Division. 2004. *Guide for Mechanistic-Empirical Design of New and Rehabilitated Pavement Structures*. National Cooperative Highway Research Program, Washington, DC. <http://onlinepubs.trb.org/onlinepubs/archive/mepdg/guide.htm>.

Cackler, T., T. Burnham, and D. Harrington. 2018. *Performance Assessment of Nonwoven Geotextile Materials Used as the Separation Layer for Unbonded Concrete Overlays of Existing Concrete Pavements in the US*. National Concrete Pavement Technology Center, Iowa State University, Ames, IA.

Cackler, T., T. Ferragut, D. S. Harrington, R. O. Rasmussen, and P. Wiegand. 2006. *Evaluation of U.S. and European Concrete Pavement Noise Reduction Methods*. National Concrete Pavement Technology Center, Ames, IA.

Covarrubias, J. P. 2012. Design of Concrete Slabs with Optimized Geometry and Built-in Curling Effect on Performance. Paper presented at 10th International Conference on Concrete Pavements, July 8–12, Quebec City, Quebec, Canada.

FHWA. 2002. High Performance Concrete Pavements: Project Summary. FHWA-IF-02-026. Federal Highway Administration, Washington, DC.

FHWA. 2005. *Surface Texture for Asphalt and Concrete Pavements*. Technical Advisory T 5040.36. Federal Highway Administration, Washington, DC.

Hall, J. W., K. L. Smith, and P. Littleton. 2009. *NCHRP Report 634: Texturing of Concrete Pavements*. National Cooperative Highway Research Program, Washington, DC.

Harrington, D. and G. Fick. 2014. *Guide to Concrete Overlays: Sustainable Solutions for Resurfacing and Rehabilitating Existing Pavements*. Third Edition. National Concrete Pavement Technology Center, Ames, IA.

Hoerner, T. E. and K. D. Smith. 2002. *PCC Pavement Texturing: Effects on Tire-Pavement Noise and Surface Friction*. Federal Highway Administration, Washington, DC.

Kosmatka, S. H. and M. Wilson. 2016. *Design and Control of Concrete Mixtures*. 16th Edition. Portland Cement Association, Skokie, IL.

Packard, R. G. 1984. *Thickness Design for Concrete Highway and Street Pavements*. Portland Cement Association, Skokie, IL. <https://ceprofs.civil.tamu.edu/dzollinger/cven-637-fall%202004/eb109.pdf>.

Pierce, L. M. and G. McGovern. 2014. *NCHRP Synthesis 457: Implementation of the AASHTO Mechanistic-Empirical Pavement Design Guide and Software*. National Cooperative Highway Research Program, Washington, DC.

Raphael, J. M. 1984. Tensile Strength of Concrete. *ACI Journal*, Vol. 8, No. 2, pp. 158–165.

Rasmussen, R. O., R. Sohaney, and P. Wiegand. 2011. *Concrete Pavement Specifications for Reducing Tire-Pavement Noise*. Tech Brief. National Concrete Pavement Technology Center, Ames, IA.

Rasmussen, R. O., P. D. Weigand, G. J. Fick, and D. S. Harrington. 2012. *How to Reduce Tire-Pavement Noise: Better Practices for Constructing and Texturing Concrete Pavement Surfaces*. National Concrete Pavement Technology Center, Ames, IA.

Scofield, L. 2003. *SR 202 PCCP Whisper Grinding Test Sections: Construction Report*. Arizona Department of Transportation, Phoenix, AZ. <https://www.igga.net/wp-content/uploads/2018/08/Arizona-SR202-PCCP-Whisper-Grinding-Test-Sections-Final-Report-2003.pdf>.

Smith, K. D. and K. T. Hall. 2001. *Concrete Pavement Design Details and Construction Practices*. Reference Manual for NHI Course 131060. National Highway Institute, Arlington, VA.

Smith, K. D., H. T. Yu, and D. G. Peshkin. 2002. *Portland Cement Concrete Overlays (State of the Technology Synthesis)*. FHWA-IF-02-045. Federal Highway Administration, Washington, DC.

Vandenbossche, J. 2016. *BCOA-ME*. Swanson School of Engineering, University of Pittsburgh, Pittsburgh, PA. http://www.engineering.pitt.edu/Sub-Sites/Faculty-Subsites/J_Vandenbossche/BCOA-ME/BCOA-ME-Technical-Documents/.

Yoder, E. J. and M. W. Witzak. 1975. *Principles of Pavement Design*. Second Edition. John Wiley and Sons, New York, NY.

Chapter 4

Fundamentals of Materials Used for Concrete Pavements

Cementitious Materials	53
Aggregates	63
Water	75
Chemical Admixtures	78
Dowel Bars, Tiebars, and Reinforcement	84
Curing Compounds	87
References	89

At its simplest, concrete is a mixture of glue (cement, water, and air) binding together fillers (aggregate) (Figure 4-1). However, other materials, such as supplementary cementitious materials (SCMs) and chemical admixtures, are added to the mixture. During pavement construction, dowel bars, tiebars, and reinforcement may be added to the system, and curing

compounds are applied to the concrete surface. All these materials affect the way concrete behaves in both its fresh and hardened states.

This chapter discusses each material in turn—why it is used, how it influences concrete, and the standard specifications that govern its use.

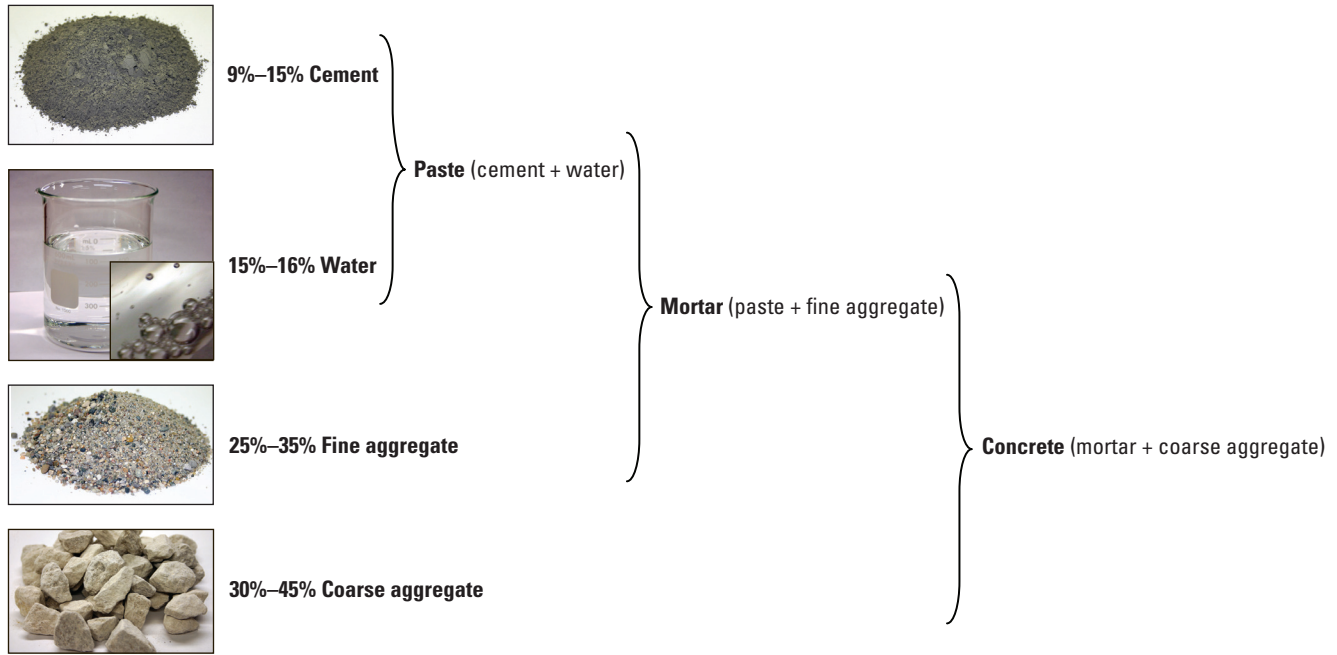

PCA, used with permission

Figure 4-1. Concrete is basically a mixture of cement, water/air, and aggregates (percentages are by volume for pavements)

Key Points

- Cementitious materials are the key components of the binder that holds concrete together. The chemical composition of the cementitious materials influences concrete behavior.
- Cementitious materials include hydraulic cements and a variety of SCMs that complement the behavior of hydraulic cements.
- Hydraulic cements react with water in a nonreversible chemical reaction (hydration) to form hydrated cement paste, a strong, stiff material.
 - Portland cement is a type of hydraulic cement commonly used in construction.
 - Blended cements are a manufactured blend of portland cement and one or more SCMs and, like portland cement, are used in all aspects of concrete construction.
- SCMs contribute to the fresh and hardened properties of concrete by reacting with water or calcium hydroxide (CH), or both, to form hydration products.
 - Some SCMs hydrate like hydraulic cements.
 - Pozzolanic SCMs react chemically with calcium hydroxide (CH) to form additional calcium silicate hydrate (C-S-H), a beneficial product of cement hydration that contributes to concrete strength and impermeability.
- Fly ash is the most widely used SCM. It is used in about 50 percent of ready-mixed concrete.
- Fly ash and slag cement can be beneficial in mixtures for paving projects because they prolong the strength-gaining stage of concrete or contribute to durability in other ways.
- It is important to test mixtures containing SCMs to ensure they are achieving the desired results, to verify the correct proportions, and to detect any unintended effects.
- Hydraulic cements can be specified using prescriptive-based specifications (ASTM C150/ C150M or AASHTO M 85, ASTM C595/ C595M or AASHTO M 240) or by a performance specification (ASTM C1157/C1157M or ASTM C1600/C1600M). Fly ash and natural pozzolans can be specified using ASTM C618 or AASHTO M 295. Slag cement can be specified using ASTM C989/C989M or AASHTO M 302.
- See Chapter 5 for details about cement chemistry and hydration.

Although aggregates account for most of the volume in concrete, the cementitious materials used significantly influence the behavior of fresh and hardened concrete. For example, the cement hydration products are more likely to be affected by chemical attack and to change dimensionally with a changing environment (e.g., drying shrinkage).

Portland cement is the most common cement used in concrete for construction. SCMs like fly ash and slag cement are typically used along with portland cement in concrete mixtures for pavements.

This section introduces the characteristics and behavior of all cementitious materials, including hydraulic cements and SCMs.

For specific information on the chemistry of cements and cement hydration, see all of Chapter 5. (For specific information on proportioning cementitious materials in concrete mixtures, see Absolute Volume Method in Chapter 7.)

Hydraulic Cement

Hydraulic cement is a material that sets and hardens when it comes in contact with water through a chemical reaction called hydration, and it is capable of doing so under water (ASTM C125). Hydration is a nonreversible chemical reaction. It results in hydrated cement paste, a strong, stiff material. ([For a complete discussion of hydraulic cement chemistry and hydration, see Chapter 5.](#))

Hydraulic cements include portland cement, calcium aluminate cement, some fly ash-based cements, and calcium sulfoaluminate cements. Portland cement is used for general construction and repair, while the other types of cement are used for special applications, such as repair or for pavements where fast turnaround times are critical (Kosmatka and Wilson 2016). Hydraulic cements are also produced pre-blended with ground calcium carbonate or SCMs and are referred to as blended cements.

Portland Cement

ASTM C150/C150M or AASHTO M 85

Portland cement is by far the most common hydraulic cement used in concrete for construction. It is composed primarily of calcium silicates, with a smaller proportion of calcium aluminates ([see Chapter 5 for more details of these compounds](#)). The composition of portland cement falls within a relatively narrow band, but specific cement properties are attained by producing different cement compositions and controlling other properties, such as fineness.

Portland cement is made by heating controlled amounts of finely ground siliceous materials (shale) and calcareous materials (limestone) to temperatures above 2,500°F. The product of this burning is a clinker, normally in the form of hard spheres approximately 1 in. in diameter. The clinker is then ground with gypsum to form the gray or white powder known as portland cement. (The inventor of the first portland cement thought its color was similar to that of rock found near Portland, England; thus, the name.) The final particle size of portland cement is around 50 percent, passing 10 microns. The particle size characteristic is generally expressed in terms of specific surface area as measured by the Blaine method (ASTM C204). The average Blaine fineness of modern portland cements ranges from 300 to 500 m²/kg, although Type III and blended cements are often higher.

Different types of portland cement are manufactured to meet physical and chemical requirements for specific purposes and to meet the requirements of applicable specifications (Johansen et al. 2005). ASTM International and the American Association of State Highway Transportation Officials (AASHTO) work to keep their respective portland cement and blended cement harmonized through the Joint AASHTO-ASTM Harmonization Task Group.

ASTM C150/C150M and AASHTO M 85 describe types of portland cement using Roman numeral designations (Table 4-1). You may see these type designations with the subscript “A,” which indicates the cement contains air-entraining admixtures (AEAs). However, air-entraining cements are not commonly available.

Table 4-1. Portland cement classifications (ASTM C150/C150M and AASHTO M 85)*

Type	Description
I	Normal
II	Moderate sulfate resistance
II (MH)	Moderate heat of hydration and moderate sulfate resistance
III	High early strength
IV	Low heat of hydration
V	High sulfate resistance

**It is not uncommon for a portland cement to meet requirements for more than one type of cement. Thus, a Type I/II cement is not a distinct cement classification, but it indicates that the cement meets specification requirements of both Type I and Type II cements.*

Blended Cements

ASTM C595/C595M or AASHTO M 240

Blended cements are manufactured by grinding or blending portland cement, or portland cement clinker, together with SCMs such as fly ash, slag cement, or another pozzolan ([see SCM information later in this chapter](#)), or by grinding with limestone or blending with ground calcium carbonate.

Blended cements are used in all aspects of concrete construction in the same applications as portland cements. Like portland cements, blended cements can be the only cementitious material in concrete, or they can be used in combination with other SCMs added at the concrete plant.

Using Blended Cements

There are advantages to using a blended cement in a concrete mixture instead of adding portland cement and one or more SCMs separately to the mixture at the concrete plant. By blending the cement and SCMs at the cement manufacturing plant, the chemical composition of the final product can be carefully and deliberately balanced, thereby reducing the risk of incompatibility problems (see Potential Materials Incompatibilities in Chapter 5). There is also less variability in the properties of a blended cement compared to SCMs added at the concrete plant.

Blended cements are defined by ASTM C595/C595M and AASHTO M 240, which are prescriptive-based specifications (Table 4-2). Like portland cements, blended cements can be used as a component in a performance-based cement as well.

Table 4-2. Blended cement classifications (ASTM C595/C595M and AASHTO M 240)

Type	Blend
IS(X)	Portland blast-furnace slag cement
IP(X)	Portland-pozzolan cement
IL(X)	Portland-limestone cement
IT(A, B)	Ternary blended cement

where:
X = targeted percentage of slag, pozzolan, or limestone
AX, BY = A and B are either "S" for slag cement, "P" for pozzolan, or "L" for limestone, whichever is present in larger amount by mass; X is the targeted percentage by mass of constituent A; and Y is the targeted percentage by mass of constituent B.

Optional requirements are indicated by suffixes added to the cement type:
(A) = air-entraining cement
(MS) = moderate sulfate resistance
(HS) = high sulfate resistance
(LH) = low heat of hydration
(MH) = moderate heat of hydration
For example, a Type IS(25)(MS) cement contains 25% slag cement and has met optional performance requirements indicating it is moderately sulfate resistant.

Performance Specifications for Hydraulic Cements
ASTM C1157/C1157 or ASTM C1600/1600M

Performance specifications classify hydraulic cements by their performance attributes rather than by their chemical composition. Under this approach, hydraulic cements must meet physical performance test requirements, as opposed to prescriptive restrictions on ingredients or chemistry as found in other cement specifications.

ASTM C1157/C1157M is designed generically for hydraulic cements, including portland cement and blended cement, and provides for six types (Table 4-3). ASTM C1600/C1600M is designed for rapid hardening cements that exhibit rapid strength gain during the first 24 hrs of hydration and provides for four types (with varying classes of hardening rate). Calcium aluminate cements, calcium sulfoaluminate cements, and hydraulic fly ash-based cements may be specified under these performance-based specifications.

Table 4-3. Performance classifications of hydraulic cement (ASTM C1157/C1157M)

Type	Performance
GU	General use
HE	High early strength
MS	Moderate sulfate resistance
HS	High Sulfate Resistance
MH	Moderate heat of hydration
LH	Low heat of hydration

Selecting and Specifying Hydraulic Cements

When specifying cements for a project, check the local availability of cement types; some types may not be readily available in all areas. If a specific cement type is not available, you may be able to achieve the desired concrete properties by combining another cement type with the proper amount of certain SCMs. For example, a Type I cement with appropriate amounts of fly ash may be able to provide a lower heat of hydration.

Allow flexibility in cement selection. Limiting a project to only one cement type, one brand, or one standard cement specification can result in increased costs and/or project delays, and it may not allow for the best use of local materials.

Do not require cements with special properties unless the special properties are necessary. Project specifications should focus on the needs of the concrete pavement and allow the use of a variety of materials to meet those needs. A cement may meet the requirements of more than one type or specification. For instance, a material classified as Type II will also comply with the requirements for Type I, and likewise a material classified as Type V will also comply with the sulfate requirements for Type II. Table 4-4 lists hydraulic cement types for various applications.

Hydraulic materials will set and harden when mixed with water. Slag cement is a hydraulic material. Pozzolanic materials require a source of calcium hydroxide (CH), usually supplied by hydrating portland cement. Class F fly ashes are typically pozzolanic, while Class C fly ash has both hydraulic and pozzolanic characteristics.

Use of SCMs in concrete mixtures has been growing in North America since the 1970s. There are similarities among many of these materials:

- SCM chemical reactions complement or are synergistic with portland cement chemical reactions.
- Most SCMs are byproducts of industrial processes.
- The judicious use of SCMs is desirable, not only for the environment and energy conservation, but also for the technical benefits they provide to concrete.

SCMs can be used to improve a particular concrete property, such as resistance to alkali-aggregate reactivity. However, mixtures containing SCMs should be tested to determine whether (1) the SCM is indeed improving the property, (2) the addition rate is optimum, and (3) there are not any unintended effects such as a significant delay in early strength gain. It is also important to remember that SCMs may react differently with different cements (see Potential Materials Incompatibilities in Chapter 5).

Using Unfamiliar Cements

As with other concrete ingredients, if an unfamiliar portland cement or blended cement is to be used, the concrete should be tested for the properties required in the project specifications (PCA 2000, Detwiler et al. 1996).

Supplementary Cementitious Materials

In at least 60 percent of modern concrete mixtures in the US, portland cement is supplemented or partially replaced by SCMs (PCA 2000). When used in conjunction with portland cement, SCMs contribute to the properties of concrete through hydraulic or pozzolanic activity, or both.

Table 4-4. Cement types for common applications*

Cement specification	General purpose	Moderate heat of hydration (massive elements)	Moderate sulfate resistance (in contact with sulfate soils or seawater)	High early strength (patching)	Low heat of hydration (very massive elements)	High sulfate resistance (in contact with high sulfate soils)
ASTM C150/ AASHTO M 85 portland cements	I	II(MH)	II, II(MH)	III	IV	V
ASTM C595/ AASHTO M 240 blended cements	IL IP IS(<70) IT(S<70)	IL(MH) IP(MH) IS(<70)(MH) IT(S<70)(MH)	IL(MS) IP(MS) IS(<70)(MS) IT(S<70)(MS)	—	IL(LH) IP(LH) IS(<70)(LH) IT(S<70)(LH)	IL(HS) IP(HS) IS(<70)(HS) IT(S<70)(HS)
ASTM C1157 hydraulic cements	GU	MH	MS	HE	LH	HS

*Check the local availability of specific cements because all cement types are not available everywhere.

Source: Adapted from Kosmatka and Wilson 2016

Traditionally, fly ash, slag cement, calcined clay, calcined shale, and silica fume have been used in concrete individually. Today, due to improved access to these materials, concrete producers can combine two or more of these materials to optimize concrete properties. Mixtures using three cementitious materials, called ternary mixtures, are becoming more common.

Table 4-5 lists the applicable specifications SCMs should meet. The use of these materials in blended cements is discussed by Detwiler et al. (1996). Table 4-6 provides typical chemical analyses and selected properties of several pozzolans.

Table 4-5. Specifications for supplementary cementitious materials

Type of SCM	Specifications
Slag cement	ASTM C989/AASHTO M 302
Fly ash and natural pozzolans	ASTM C618/AASHTO M 295
Silica fume	ASTM C1240
Blended SCMs	ASTM C1697
Highly reactive pozzolans	AASHTO M 321

Table 4-6. Chemical analyses and selected properties of Type I cement and several supplementary cementitious materials

	Type I portland cement	Class F fly ash	Class C fly ash	Slag cement	Silica fume	Calcined clay	Calcined shale	Metakaolin
SiO ₂ , %	19.8	52	35	35	90	58	50	53
Al ₂ O ₃ , %	5.1	23	18	12	0.4	29	20	43
Fe ₂ O ₃ , %	2.5	11	6	1	0.4	4	8	0.5
CaO, %	63.3	5	21	40	1.6	1	8	0.1
SO ₃ , %	3.3	0.8	4.1	2	0.4	0.5	0.4	0.1
Na ₂ O, %	0.2	1.0	5.8	0.3	0.5	0.2	—	0.05
K ₂ O, %	0.7	2.0	0.7	0.4	2.2	2	—	0.4
Na ₂ O _{eq} , %	0.62	2.2	6.3	0.6	1.9	1.5	—	0.3
Loss on ignition, %	2.2	2.8	0.5	1.0	3.0	1.5	3.0	0.7
Fineness, ft²/lb								
Blaine	1,938	2,051	2,051	1,953		4,834	356	
Nitrogen absorption					97,649			83,001
Relative density	3.15	2.38	2.65	2.94	2.40	2.50	2.63	2.50

Source: Kosmatka and Wilson 2016

Types of Supplementary Cementitious Materials

Fly Ash

Fly ash is the most widely used SCM in concrete. It is used in about 50 percent of all ready-mixed concrete (PCA 2000).

Class F fly ashes are pozzolans but may have some hydraulic properties. Most Class C ashes, when exposed to water, will hydrate and harden, meaning they are a hydraulic material. However, Class C ash may also exhibit pozzolanic properties.

Fly ash generally affects concrete as follows:

- Less water is normally required to achieve a given level of workability
- Setting time may be delayed
- Early strengths may be decreased, but later strengths increased, because fly ash reaction rates are initially slower and continue longer
- Heat of hydration is reduced

- Resistance to alkali-silica reaction (ASR) and sulfate attack is improved when the appropriate fly ash and substitution rate is used
- Permeability is reduced; consequently, resistance to chloride ion penetration is improved
- Incompatibility with some cements and chemical admixtures may cause early stiffening

Generally, mixture designs for pavements will include Class F fly ash at 15 to 25 percent by mass of the total cementitious material. Class C fly ash is used in higher amounts, typically 15 to 40 percent of the total cementitious material. The amount of fly ash used should be based on the desired effects on the concrete.

Fly ash is a byproduct of burning finely ground coal along with other materials added in the fuel mixture in power plants. During combustion of the pulverized coal fuel, residual minerals in the coal and the additives melt and fuse in suspension, and then they are carried through the combustion chamber by the exhaust gases. In the process, the fused material cools and solidifies into spherical glassy ash particles (Figure 4-2). The fly ash is then collected from the exhaust gases by electrostatic precipitators or fabric bag filters.

Fly ash is primarily silicate glass containing silica, alumina, calcium, and iron. Minor constituents are sulfur, sodium, potassium, and carbon, all of which can affect concrete properties. Crystalline compounds should be present in small amounts only. The specific gravity of fly ash generally ranges between 1.9 and 2.8. The color is gray or tan.

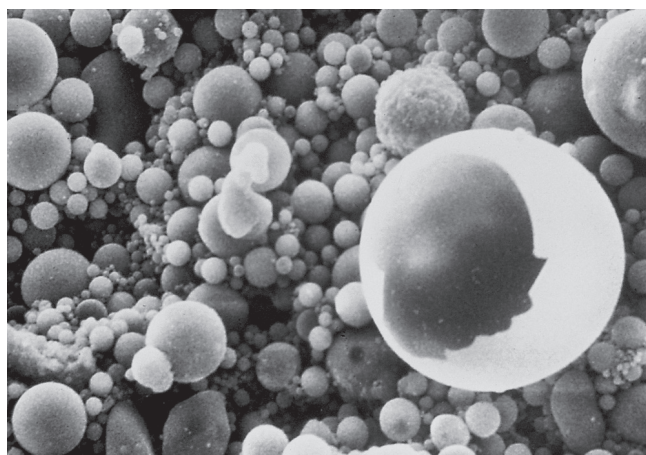

Note the characteristic spherical shape that helps improve workability. Average particle size is approximately 0.4 mil.

Kosmatka and Wilson. 2016, © 2016 PCA, used with permission

Figure 4-2. Scanning electron micrograph of fly ash particles

Particle sizes vary from less than 1 μm to more than 100 μm , with the majority measuring under 10 μm in diameter. The surface area is typically 300 to 500 m^2/kg , similar to cement (Figure 4-3).

Fly ash will lose mass when heated to 1,830°F, mainly due to organic volatiles and combustion of residual carbon. This mass loss is referred to as loss on ignition (LOI) and is limited in applicable specifications to less than 6 percent.

ASTM C618 and AASHTO M 295 Class F and Class C fly ashes are used in many different types of concrete. For more information on fly ash, see ACAA (2003) and ACI 232 (2003).

Recent trends in power production include conversion to natural gas fuels, which results in less fly ash production. Also, the coal combustion residuals (CCR) rule has led to the rapid closure of all surface impoundments of fly ash. Together, these changes have caused ash providers to increasingly turn to fly ash recovered from landfills and impoundments to meet the needs of the concrete industry. Recovered fly ash is required to meet all requirements of ASTM C618 or AASHTO M 295.

Slag Cement

Slag cement has been used as a cementitious material in concrete since the beginning of the 1900s (Abrams 1924). Because of its chemical composition, slag cement behaves as a hydraulic, but hydration rates are significantly accelerated when CH is present or the pH of the system is otherwise increased.

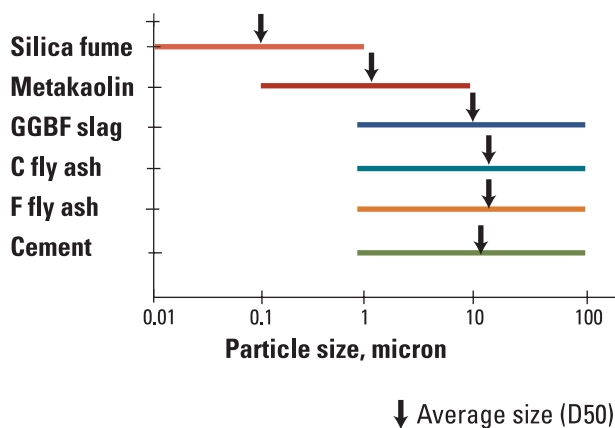

CTLGroup, used with permission

Figure 4-3. Typical size distributions of cementitious materials

Slag cement generally affects concrete as follows:

- Slightly less water is required to achieve the same workability
- Setting time may be delayed
- Early strengths may be reduced, but later strengths are increased
- Resistance to chloride penetration is significantly improved

When used in general purpose concrete for paving mixtures in North America, slag cement commonly constitutes at least 35 percent of the cementitious material. Higher dosages may be considered if required for providing resistance to alkali-silica reaction, improvement of resistance to deicer chemicals, or reducing the heat of hydration.

Slag cement is a byproduct of producing iron from iron ore. It is the molten nonferrous material that separates from the iron in a blast furnace. It is drained from the furnace and granulated by pouring it through a stream of cold water, or pelletized by cooling it in cold water and spinning it into the air using a rotary drum. The resulting quenched solid is a glassy material that is ground to a size similar to portland cement (Figure 4-4). Slag that is not rapidly cooled or granulated is not useful as an SCM, but it can be used as a coarse aggregate.

The granulated material is normally ground to a Blaine fineness of about 400 to 700 m²/kg. The specific gravity for slag cement is in the range of 2.85 to 2.95. The bulk density varies from 66 to 86 lb/ft³.

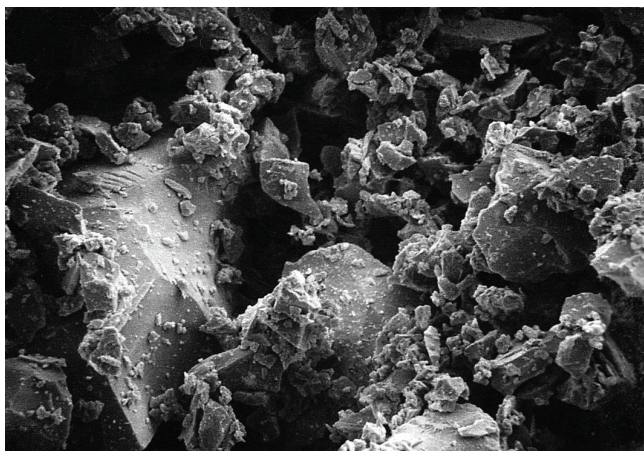

Note the angular shape.

Kosmatka and Wilson, 2016, © 2016 PCA, used with permission

Figure 4-4. Scanning electron micrograph of slag cement particles

Slag cement consists essentially of silicates and aluminosilicates of calcium, the same basic phases in portland cement. Slag cement generally does not contain tricalcium aluminate (C₃A), which affects setting.

ASTM C989/C989M and AASHTO M 302 classify slag cement by its level of reactivity as Grade 80, 100, or 120 (where Grade 120 is the most reactive). ACI 233 (2003) provides an extensive review of slag cement.

Natural Pozzolans

In general, pozzolans are included in concrete mixtures to help convert CH, a less desirable product of hydration, into the more desirable C-S-H ([see the discussion of CH to C-S-H conversion in the section on Pozzolanic SCMs in Chapter 5](#)).

Natural pozzolans have been used for centuries. The term “pozzolan” comes from a volcanic ash mined at Pozzuoli, a village near Naples, Italy. However, the use of volcanic ash and calcined clay dates back past 2,000 B.C. Many of the Roman, Greek, Indian, and Egyptian pozzolan concrete structures can still be seen today, attesting to the durability of these materials.

ASTM C618 defines Class N pozzolans as “raw or calcined natural pozzolans.” The most common Class N pozzolans used today are processed materials, having been heat-treated in a kiln and then ground to a fine powder; they include calcined clay, calcined shale, and metakaolin.

Calcined clays are used in general purpose concrete construction in much the same way as other pozzolans. They can be used as a component of the total cementitious material, typically in the range of 15 to 35 percent, and can enhance strength development and resistance to sulfate attack, control ASR, and reduce permeability. Calcined clays have a relative density between 2.40 and 2.61, with Blaine fineness ranging from 3,173.6 to 6,591.3 ft²/lb.

Calcined shale may contain on the order of 5 to 10 percent calcium, which results in its having some cementing or hydraulic properties.

Metakaolin is produced by low-temperature calcination of high-purity kaolin clay. The product is ground to an average particle size of about 0.04 to 0.08 mil; this is about 10 times finer than cement, but still 10 times coarser than silica fume. Metakaolin is used in special applications where very low permeability or very high strength is required. In these applications, metakaolin is used as an addition to the total cementitious material, not as a component of an overall cementitious content.

Typical additions are around 10 percent of the total of all other cementitious materials.

Natural pozzolans are emerging as one alternative to fly ash and slag cement for general purpose concrete. They are geographically limited, however, with primary deposits in the US being located in the western states. Natural pozzolans are classified as Class N pozzolans by ASTM C618 and AASHTO M 295. ACI 232.1R (2012) provides a review of natural pozzolans.

Silica Fume

Because it can reduce workability and is expensive, silica fume is typically not used in pavements except for special applications such as those subjected to studded tires or in curbs and gutters.

Silica fume, also referred to as microsilica or condensed silica fume, is a byproduct of the silicon or ferrosilicone industries. The product is the vapor that rises from electric arc furnaces used to reduce high-purity quartz with coal. When it cools, it condenses and is collected in fabric filters, then processed to remove impurities. The particles are extremely small, some 100 times smaller than cement grains, and are mainly glassy spheres of silicon dioxide.

The loose bulk density is very low and the material is difficult to handle. In order to improve handling, silica fume is usually densified by tumbling in an air stream that causes the particles to agglomerate into larger grains held together by electrostatic forces. It is important that concrete mixtures containing silica fume are batched and mixed in a way that ensures these agglomerations are broken up and the material is uniformly distributed in the mixture.

The material is used as a pozzolan and is specified in ASTM C1240 and AASHTO M 307. The water requirement of silica fume may be high, requiring that superplasticizers be used in concrete containing more than 5 percent silica fume by mass of cement. The resulting concrete normally exhibits significantly increased strength and reduced permeability. Concrete containing silica fume is often at higher risk of plastic shrinkage cracking because bleeding is markedly reduced. Specific gravity of silica fume is in the range of 2.2 to 2.6.

Other Pozzolans

Other industrial byproducts like rice husk ash and some nonferrous slags are used as pozzolans. There is no specification for these materials. In some cases, they may meet the requirements of AASHTO M 321 for high-reactivity pozzolans. For materials that do not fall under categories covered by other specifications, ASTM has a guide, ASTM C1709, for evaluating these materials for their suitability in concrete.

Effects of Supplementary Cementitious Materials in Concrete

SCMs in concrete affect a wide range of fresh and hardened concrete properties. Some of the effects may be considered desirable and are the reason why the materials are used. Other side effects may be less desirable and have to be accommodated. An understanding of all the potential effects is essential to prevent surprises.

The effects of SCMs on properties of fresh and hardened concrete are briefly discussed in the following sections and summarized in Figures 4-5 and 4-6, respectively ([see Chapter 6 for a complete discussion of concrete properties](#)).

In most cases, the extent of change in concrete behavior will depend on the particular material used, the amount used, and the properties of other ingredients in the concrete mixture.

Trial batching with unfamiliar material combinations is essential to provide assurance of critical concrete properties.

Fresh Properties

In fresh concrete, SCMs can affect workability and setting times in the following ways:

- Workability is always changed by SCMs. Fly ash will generally increase workability, as will slag cement to a lesser extent. Silica fume may significantly reduce workability when used at a level greater than 5 percent of total cementitious material.
- The rate of slump loss (stiffening) may be increased if there are chemical incompatibilities ([see Potential Materials Incompatibilities in Chapter 5](#)).
- Setting times may be delayed and early strength gain slowed if slag cement and fly ash are included. However, this effect will depend on the product used.

	Fly ash				Natural pozzolans		
	Class F	Class C	Slag cement	Silica fume	Calcined shale	Calcined clay	Metakaolin
Water demand	↓	↓	↓	↑	↔	↔	↑
Workability	↑	↑	↑	↓	↑	↑	↓
Bleeding and segregation	↓	↓	↕	↓	↔	↔	↓
Setting time	↑	↕	↑	↔	↔	↔	↔
Air content	↓	↓	↔	↓	↔	↔	↓
Heat of hydration	↓	↕	↓	↔	↓	↓	↔

Effect depends on material composition, dosage, and other mixture parameters

Key: ↓ lowers
↑ increases
↕ may increase or lower
↔ no impact

Source: Kosmatka and Wilson 2016, PCA

Figure 4-5. Effects of supplementary cementitious materials on fresh concrete properties

	Fly ash				Natural pozzolans		
	Class F	Class C	Slag cement	Silica fume	Calcined shale	Calcined clay	Metakaolin
Early age strength gain	↓	↔	↕	↑	↓	↓	↑
Long term strength gain	↑	↑	↑	↑	↑	↑	↑
Abrasion resistance	↔	↔	↔	↔	↔	↔	↔
Drying shrinkage and creep	↔	↔	↔	↔	↔	↔	↔
Permeability and absorption	↓	↓	↓	↓	↓	↓	↓
Corrosion resistance	↑	↑	↑	↑	↑	↑	↑
Alkali-silica reactivity	↓	↓	↓	↓	↓	↓	↓
Sulfate resistance	↑	↕	↑	↑	↑	↑	↑
Freezing and thawing	↔	↔	↔	↔	↔	↔	↔
Deicer scaling resistance	↔	↔	↔	↔	↔	↔	↔

Effect depends on material composition, dosage, and other mixture parameters; these general trends may not apply to all materials and therefore testing should be performed to verify the impact.

Key: ↓ lowers
↑ increases
↕ may increase or lower
↔ no impact
↔ may lower or have no impact

Source: Kosmatka and Wilson 2016, PCA

Figure 4-6. Effects of supplementary cementitious materials on hardened concrete properties

All of these factors can have a significant effect on the timing of finishing and saw cutting in pavements, making it important to test the performance of the cementitious system being selected for a project in trial batches well before the project starts. Trial batches need to be tested at the temperatures expected when the paving operation will be conducted.

Durability/Permeability

SCMs generally improve potential concrete durability by reducing permeability. Almost all durability-related failure mechanisms involve the movement of fluids through the concrete. Tests show the permeability of concrete decreases as the quantity of hydrated cementitious materials increases and the water-to-cementitious materials (w/cm) ratio decreases.

With adequate curing, fly ash, slag cement, and natural pozzolans generally reduce the permeability and absorption of concrete. Slag cement and fly ash can result in very low chloride penetration at later ages. Silica fume and metakaolin are especially effective and can provide concrete with very low chloride penetration (Barger et al. 1997).

In order for SCMs to improve durability, they must be of adequate quality and used in appropriate amounts, and finishing and curing practices must be appropriate.

Alkali-Silica Reactivity Resistance

The alkali-silica reactivity of most reactive aggregates (see [Aggregate Durability](#) later in this chapter) can be controlled with the use of certain SCMs. Low-calcium Class F fly ashes have reduced reactivity expansion, up to 70 percent or more in some cases. At optimum proportioning, some Class C fly ashes can also reduce reactivity, but at a low level a high-calcium Class C fly ash may exacerbate ASR. This is referred to as the pessimum effect. For further discussion, see Thomas et al. (2013).

SCMs mitigate ASR (Bhatty 1985, Bhatty and Greening 1978) by producing additional C-S-H that chemically tie up the alkalis in the concrete, reducing the alkali content of the system, and reducing permeability, thus slowing the ingress of water.

It is important to determine the optimum proportioning for a given set of materials to maximize the reduction in reactivity and to avoid dosages and materials that can aggravate reactivity. SCM proportioning should be verified by tests, such as ASTM C1567 or ASTM C1293. (Descriptions of aggregate testing and preventive measures to be taken to prevent deleterious alkali-aggregate reaction are discussed later in this chapter under [Aggregate Durability](#).)

SCMs that mitigate alkali-silica reactions will not mitigate alkali-carbonate reactions, a type of reaction involving cement alkalis and certain dolomitic limestones. Alkali-carbonate reactivity (ACR) cannot be mitigated by any approach.

Sulfate Resistance

With proper proportioning and materials selection, silica fume, fly ash, natural pozzolans, and slag cement can improve the resistance of concrete to external sulfate attack. This is done primarily by reducing permeability and by reducing the amount of reactive phases, such as tricalcium aluminate (C₃A), that contribute to expansive sulfate reactions.

One study showed that for a particular Class F ash, an adequate amount was approximately 20 percent of the cementitious system (Stark 1989). It is also effective to control permeability through mixtures with low w/cm ratios (see the section on [Sulfate Resistance](#) in Chapter 6).

Concrete produced with Class F ash is generally more sulfate resistant than concrete produced with Class C ash. Slag cement is generally considered beneficial in sulfate environments. However, slag cement must be 50 percent or more of the total cementitious material in order to effectively mitigate sulfate attack (ACI 233R-13).

Calcined clay has been demonstrated to provide sulfate resistance greater than high-sulfate resistant Type V cement (Barger et al. 1997).

Resistance to Freeze-Thaw Damage and Deicer Scaling

There is a perception that concrete containing SCMs is more prone to frost-related damage than plain concrete. This is partially due to the severity of the test methods used (i.e., ASTM C666/C666M, ASTM C672/C672M) but may also be related to the changing bleed rates and finishing requirements for concretes with SCMs (Schlorholtz 2008, Bektas 2010). With or without SCMs, concrete that is exposed to freezing cycles must have sound aggregates (see [Aggregate Durability](#) later in this chapter), adequate strength, a proper air-void system, and proper curing methods.

For concrete subject to deicers, the ACI 318 (2014) building code states the maximum proportion of fly ash, slag cement, and silica fume should be 25, 50, and 10 percent by mass of cementitious materials, respectively. Total SCM content should not exceed 50 percent of the cementitious material. Concretes, including pavement mixtures, with SCMs at proportions higher than these limits may still be durable, however.

Selection of materials and proportions should be based on local experience. Durability should be demonstrated by field or laboratory performance when new materials and mixture designs are introduced.

Drying Shrinkage

When used in low to moderate amounts, the effect of fly ash, slag cement, calcined clay, calcined shale, and silica fume on the drying shrinkage of concrete of similar strength is generally small and of little practical significance.

Effect of Pozzolans in Cement Paste

In very broad terms, the primary reaction in hydrating cement is the following:

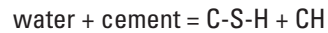

C-S-H is the primary compound that contributes to the strength and impermeability of hydrated cement paste. CH is not as strong and is more soluble, so it is somewhat less desirable.

Adding a pozzolan like fly ash, in the presence of water, results in conversion of the CH to more C-S-H:

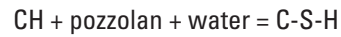

This conversion is a significant benefit of adding pozzolans like fly ash to the mixture. (See Chapter 5 for a detailed description of cement chemistry and hydration, including the effects of specific SCMs on the hydration process.)

Aggregates

Key Points

- In concrete, aggregate (rocks and minerals) is the filler held together by the cement paste. Aggregate forms the bulk of the concrete system.
- Aggregates are generally chemically and dimensionally stable; therefore, it is desirable to maximize aggregate content in concrete mixtures compared to the more chemically reactive cement paste.
- Aggregate strongly influences concrete's fresh properties (particularly workability) and long-term durability.
- It is critical that the aggregate be well graded. That is, there should be a wide range of aggregate particle sizes. Well-graded aggregate has less space between aggregate particles to be filled with the more chemically reactive cement paste. It also contributes to achieving a workable mixture with a minimum amount of water.
- For durable concrete pavements, the aggregate should be durable. In general, this means not alkali reactive, not prone to frost damage, or not susceptible to salt damage. Many kinds of aggregate can be used, but granite and limestone are common in concrete pavements.
- Always prepare trial batches of concrete using the specific project aggregates to establish the final mixture characteristics and, if necessary, make adjustments to the mixture.
- The physical and durability requirements of aggregate for concrete mixtures, as well as classifications of coarse and fine aggregates, are covered in ASTM C33/C33M.

Aggregate—rocks and minerals—is the filler held together by cement paste. Aggregate typically accounts for 60 to 75 percent of concrete by volume. Compared to cement paste, aggregates are generally more chemically stable and less prone to moisture-related

volume changes. Therefore, in concrete mixtures it is desirable to maximize the volume of aggregate and reduce the volume of cement while maintaining desired concrete properties.

Aggregates used in concrete mixtures for pavements must be clean, hard, strong, durable, and relatively free of absorbed chemicals, coatings of clay, and other fine materials that could affect hydration and bonding with the cement paste. Aggregates are often washed and graded at the pit or plant. Some variation in type, quality, cleanliness, grading, moisture content, and other properties is expected from load to load.

Ways to Describe Aggregates

Aggregates—rocks and minerals—can be described by their general composition, source, or origin:

- General composition
 - Mineral: Naturally occurring substance with an orderly structure and defined chemistry
 - Rock: Mixture of one or more minerals
- Source
 - Natural sands and gravels: Formed in riverbeds or seabeds and usually dug from a pit, river, lake, or seabed; sands are fine aggregates; gravels are coarser particles
 - Manufactured aggregate (crushed stone or sand): Quarried in large sizes, then crushed and sieved to the required grading; also, crushed boulders, cobbles, or gravel
 - Recycled: Made from crushed concrete
- Origin
 - Igneous: Cooled molten material; includes siliceous materials primarily consisting of compounds of silica (for example, granite)
 - Sedimentary: Deposits squeezed into layered solids; includes carbonate materials from deposited seashells (for example, limestone)
 - Metamorphic: Igneous or sedimentary rocks that have been transformed under heat and pressure

Service records are invaluable in evaluating aggregates, particularly with respect to ASR. In the absence of a performance record, aggregates should be tested before they are used in concrete. As with the introduction of any material into a concrete mixture design, prepare trial batches using the specific project aggregates to establish the characteristics of the resultant concrete mixture and identify any necessary mixture adjustments.

This section describes the types of aggregates and the properties of aggregates that affect concrete mixes for pavements.

Aggregate Types

Aggregates are sometimes identified by their mineralogical classification, that is, by their chemistry and how they were formed. These classifications are important because they provide a means of partially predicting a specific aggregate's effect on plastic and hardened concrete mixtures. However, different materials from the same geological formation may be significantly different. Before using aggregate from a new source or quarry, verify its performance in concrete mixtures.

Naturally occurring aggregates, like those from pits or quarries, are a mixture of rocks and minerals (see ASTM C294 for brief descriptions). A mineral is a naturally occurring solid substance with an orderly internal structure and a narrow chemical composition range. Rocks are generally composed of several minerals.

Single-mineral rocks that may be used for concrete aggregates include dolomite and magnetite. Minerals that appear in rocks used for aggregates include silica (e.g., quartz), silicates (e.g., feldspar), and carbonates (e.g., calcite). Rock types composed of more than one mineral include granite, gabbro, basalt, quartzite, traprock, limestone, shale, and marble.

These lists are not exhaustive. More information is shown in Tables 4-7 and 4-8.

Rocks are classified according to their origin. Igneous rocks are the product of cooled molten magma, sedimentary rocks are the product of sediment deposits compressed into layered solids, and metamorphic rocks are the product of igneous or sedimentary rocks that have been transformed under heat and pressure.

Table 4-7. Mineral constituents in aggregates

Silica	Quartz	
	Opal	
	Chalcedony	
	Tridymite	
	Cristobalite	
Silicates	Feldspars	
	Ferromagnesian	
	Hornblende	
	Augite	
	Clay	
	Illites	
	Kaolins	
	Chlorites	
	Montmorillonites	
	Mica	
	Zeolite	
	Carbonate	Calcite
		Dolomite
Sulfate	Gypsum	
	Anhydrite	
Iron sulfide	Pyrite	
	Marcasite	
	Pyrrhotite	
Iron oxide	Magnetite	
	Hematite	
	Goethite	
	Imenite	
	Limonite	

Source: Kosmatka and Wilson 2016

Coarse-grained igneous rocks (for example, granite) and sedimentary rocks consisting of carbonate materials from deposited sea shells (for example, limestone) are two rock types commonly used as aggregate in concrete, as discussed below. Carbonate materials are primarily composed of calcium compounds; whereas, siliceous materials (including granite) are predominantly based on compounds of silica.

Table 4-8. Rock constituents in aggregates*

Igneous rocks	Sedimentary rocks	Metamorphic rocks	
Granite	Conglomerate	Marble	
Syenite	Sandstones	Metaquartzite	
Diorite		Quartzite	Slate
Gabbro (Traprock)	Graywacke	Phyllite	
Peridotite	Subgraywacke	Schist	
Pegmatite	Arkose	Amphibolite	
Volcanic glasses	Claystone, siltstone, argillite, and shale	Hornfels	
Obsidian	Carbonates	Gneiss	
Pumice		Limestone	Serpentinite
Tuff		Dolomite	
Scoria		Marl	
Perlite		Chalk	
Pitchstone		Chert	
Felsite			
Basalt			

*Roughly in order of abundance.

Source: Kosmatka and Wilson 2016

For a detailed discussion of other rock types, see Barksdale (1991).

The types of aggregates have different effects on the performance of concrete in different environments and traffic. For instance, siliceous materials tend to resist wearing and polishing. Carbonate rocks have low coefficients of thermal expansion, which is beneficial in reducing expansion and shrinkage in climates where large fluctuations in temperature occur ([see the section on Aggregate Coefficient of Thermal Expansion later in this chapter](#)).

Some rock types are unsound for use in concrete mixtures because they expand, causing cracking. Examples include shale and siltstone.

Carbonate Rock

There are two broad categories of carbonate rock: (1) limestone, composed primarily of calcite, and (2) dolomite, composed primarily of the mineral dolomite. Mixtures of calcite and dolomite are common (Figure 4-7).

Carbonate rock has several different modes of origin and displays many textural variations. Two carbonate rocks having the same origin may display a great range of textures. In some carbonate rocks, the texture is so dense that individual grains are not visible. Others may have coarse grains with the calcite or dolomite readily recognizable. In many carbonate rocks, fragments of seashells of various kinds are present. Shell sands and shell banks, as well as coral reefs and coralline sands, are examples of carbonate deposits.

Carbonate rocks display a large range of physical and chemical properties. They vary in color from almost pure white through shades of gray to black. The darker shades are usually caused by plant-based (carbonaceous) material. The presence of iron oxides creates buffs, browns, and reds. Dolomite is commonly light in color. It often has ferrous iron compounds that may oxidize, tinting the rock shades of buff and brown.

The properties of limestone and dolomite vary with the degree of consolidation. The compressive strength of commercial limestone typically varies from 10,000 to 15,000 lb/in². The porosity of most limestone and dolomite is generally low, and the absorption of liquids is correspondingly small.

Granite

Granites are igneous rocks composed predominantly of forms of silica (for example, quartz) and silicates (for example, feldspar). The grain or texture varies from fine to coarse. Granites may vary markedly in color and texture within individual quarries, but more commonly the color and texture are uniform for large volumes of rock.

Because of its mineral composition and interlocking crystals, granite is hard and abrasion resistant. Its compressive strength typically ranges from 7,000 to 60,000 lb/in², with the typical value of 24,000 lb/in² in the dry state. Most granite is capable of supporting any load to which it might be subjected during ordinary construction uses. The flexural strength of intact granite, expressed as a Modulus of Rupture (MOR), varies from about 9 to 1,300 to 4,000 lb/in². The modulus of elasticity of granite is higher than that of any of the other rock types for which data are available.

Gravel and Sand

Close to half of the coarse aggregates used in concrete in North America are natural gravels dug or dredged from a pit, river, lake, or seabed. Weathering and erosion of rocks produce particles of stone, gravel, sand, silt, and clay. Gravel (including sand) is natural material that has broken off from bedrock and has been transported by water or ice. During transport, gravel is rubbed smooth and graded to various sizes.

	(1) Calcite (mineral), CaCO ₃	100	90	80	70	60	50	40	30	20	10	0
Mineral component, %	(2) Dolomite (mineral), CaMg(CO ₃) ₂	0	10	20	30	40	50	60	70	80	90	100
Rock type		High calcium limestone	Magnesium limestone		Dolomitic limestone				Calcitic dolomite			Dolomite

CTLGroup, used with permission

Figure 4-7. Family of carbonate minerals showing rock and mineral names

Gravel and sand are often a mixture of several minerals or rock types. The quality (or soundness) of sand and gravel depends on the bedrock from which the particles were derived and the mechanism by which they were transported. Sand and gravel derived from sound rocks, like many igneous and metamorphic rocks, tend to be sound. Sand and gravel derived from rocks rich in shale, siltstone, or other unsound materials tend to be unsound.

Sand and gravel deposited at higher elevations from glaciers may be superior to deposits in low areas. The reason is that the rock high in an ice sheet has been carried from higher, more mountainous areas, which tend to consist of hard, sound rocks. Sand and gravel that have been smoothed by prolonged agitation in water (Figure 4-8 [bottom]) usually are considered better quality because they are harder and have a more rounded shape than less-abraded sand and gravel.



Kosmatka and Wilson 2016 , © 2016 PCA, used with permission

Figure 4-8. Aggregates produced by crushing operation (top) have a rougher surface texture and are angular compared to round river gravel (bottom)

Manufactured Aggregate

Manufactured aggregate (including manufactured sand) is often used in regions where natural gravels and sands are either not available in sufficient quantities or are of unsuitable quality (Owens 2001). It is produced by crushing sound parent rock at stone crushing plants.

Manufactured aggregates differ from gravel and sand in their grading, shape, and texture. Because of the crushing operation, they have a rough surface texture, are very angular in nature (Figure 4-8 [top]), and tend to be cubical in shape (depending on the method of crushing) and uniform in grade (size) (Wigum et al. 2004). In the past, manufactured sands were often produced without regard to sizing, but producers can now provide high-quality material meeting specified particle shapes and gradations (Addis and Owens 2001). In many cases, the particle elongation and flakiness of manufactured sands can be reduced through appropriate crushing techniques. Impact crushers generate better particle shape than compression crushers.

Many of the characteristics of manufactured aggregates are attributable directly to the inherent properties of the rock type from which they were produced. Manufactured aggregates are less likely than gravel and sand to be contaminated by deleterious substances such as clay minerals or organic matter (Addis and Owens 2001). Some specifications permit higher fines content in manufactured sands because of the expectation of less clay contamination (Addis and Goldstein 1994).

The sharpness and angularity of manufactured sands may result in a “harsh” mixture—one that is difficult to work and finish. Such mixtures also typically require more water (Quiroga and Fowler 2004). On the other hand, the appropriate use of manufactured sand can improve edge slump control during slipform paving and may also lead to slight increases in concrete strength for a fixed water content (McCaig 2002). As with the introduction of any material into a concrete mixture design, prepare trial batches using the specific project materials to establish the characteristics of the resultant concrete mixture and identify any necessary mixture adjustments.

Recycled Aggregates

Recycling concrete pavement is a relatively simple process. It involves breaking and removing the pavement, removing reinforcement and other embedded items, and crushing the concrete into material with a specified size. The crushing characteristics of hardened concrete are similar to those of natural rock and are not significantly affected by the grade or quality of the original concrete.

According to an Federal Highway Administration (FHWA) study (2002), many states use recycled aggregate as an aggregate base. Recycled-aggregate bases have experienced some leaching of calcium carbonate into the subdrains (Snyder et al. 2018).

In addition to using recycled aggregate as a base, some states use recycled concrete in new portland cement concrete. (Table 3.1 in Snyder et al. 2018 includes a checklist of considerations for use of recycled concrete aggregate [RCA] in different applications.) Most of these agencies specify recycling the concrete material directly back into the project being reconstructed. When used in new concrete, recycled aggregate is generally combined with virgin aggregate. Recycled material is not recommended for use as fine aggregate, however, because of the high water demand.

The quality of concrete made with recycled coarse aggregate depends on the quality of the recycled aggregate. Typically, recycled coarse aggregate is softer than natural aggregate and may have a higher alkali or chloride content than natural aggregate. Recycled aggregate may also have higher porosity, leading to higher absorption. Therefore, relatively tighter quality controls (QCs) may be required to prevent constructability problems. The recycled aggregate should be taken from a single pavement that is known not to have experienced materials-related problems. Care must be taken to prevent contamination of the recycled aggregate by dirt or other materials, such as asphalt.

More than 100 projects have been constructed in the US using recycled crushed concrete as a part of the aggregate system (Snyder et al. 1994, Reza and Wilde 2017). Most have performed satisfactorily; whereas, others have indicated some limitations and presented opportunities to identify some of the changes required when using RCA

in concrete paving mixtures (FHWA 2007). A thorough review by the Minnesota Department of Transportation (MnDOT) indicated that durable concrete mixtures can be prepared using RCA if the properties of the RCA are properly evaluated and accounted for in mixture proportioning (Reza and Wilde 2017).

Table 4-9 provides an overview of how mixture properties may be affected when using RCA. The important point to keep in mind is that there are potential adjustments to the mixture that can be considered during the mixture design stage that will enable the mixture properties to satisfy the mixture design requirements.

Physical Properties of Aggregates

The factors that can be monitored in an aggregate from a given source are the grading, particle shape, texture, absorption, and durability. In general, the required physical and durability characteristics of aggregates are covered in ASTM C33/C33M.

Aggregate Gradation

Gradation is a measure of the size distribution of aggregate particles, determined by passing aggregate through sieves of different sizes (ASTM C136/C136M and AASHTO T 27). Grading and grading limits are usually expressed either as the percentage of material passing or retained on sieves with designated opening sizes. Aggregates are classified as fine or coarse materials by ASTM C33/C33M and AASHTO M 6/M 80 as follows:

- **Coarse:** Aggregate retained on a #4 sieve (greater than 3/16 in. in diameter) (Abrams and Walker 1921); consists of gravel, crushed gravel, crushed stone, air-cooled blast furnace slag (ACBFS) (not the slag cement used as an SCM), or crushed concrete; maximum size generally in the range of 3/8 to 1 1/2 in.

Table 4-9. Summary of mixture properties that may be affected when using RCA and potential consideration for mitigating the changes in mixture properties

Property	Coarse RCA only	Coarse and fine RCA	Potential adjustments
Compressive strength	0%–24% lower	15%–40% lower	Reduce w/cm ratio
Tensile strength	0%–10% lower	10%–20% lower	Reduce w/cm ratio
Variability of strength	Slightly greater	Slightly greater	Increase average strength compared to specified strength
Modulus of elasticity	10%–33% lower	25%–40% lower	May be considered a benefit with respect to cracking of slabs on grade
Coefficient of thermal expansion/contraction	0%–30% higher	0%–30% higher	Reduce panel sizes
Drying shrinkage	20%–50% higher	70%–100% higher	Reduce panel sizes
Permeability	0%–500% higher	0%–500% higher	Reduce w/cm ratio
Specific gravity	0%–10% lower	5%–15% lower	—

- **Fine:** Aggregate passing a #4 sieve (less than $\frac{3}{16}$ in. in diameter) (Abrams and Walker 1921); consists of natural sand, manufactured sand, or a combination
- **Clay:** Very small, fine particles with high surface area and a particular chemical form

Why Well-Graded Aggregate Is Critical

Because aggregates are generally more chemically and dimensionally stable than cement paste, it is important to maximize the amount of aggregate in concrete mixtures, within other limits, like the need for sufficient paste to coat all the aggregate particles for workability. This can be accomplished largely by selecting the optimum aggregate grading. Well-graded aggregate—that is, aggregate with a balanced variety of sizes—is preferred, because the smaller particles fill the voids between the larger particles, thus maximizing the aggregate volume (Figure 4-9).

In Figure 4-9, the level of liquid in the cylinders, representing voids, is constant for equal absolute volumes of aggregates of uniform (but different) sizes.

Generally Desirable Physical Properties of Aggregate

Although mixtures can be developed to compensate for the lack of some of the following characteristics in the aggregate, in general it is desirable that the aggregate has the following qualities:

- Well graded (for mixtures that require less water than mixtures with gap-graded aggregates, have less shrinkage and permeability, are easier to handle and finish, and are usually the most economical)
- Rough surface texture (for bond and interlock)
- Low absorption (reduces water requirement variability)
- Low alkali-aggregate reactivity (for reduced risk of deleterious ASR and ACR)
- Frost resistant (for durability associated with D-cracking and popouts)
- Low salt susceptibility (for durability)
- Low coefficient of thermal expansion (CTE) (for reduced cracking from volume change due to changing temperatures)
- Abrasion resistant (for durability and skid resistance)

When different sizes are combined, however, the void content decreases.

In addition, the amount of mixture water is often governed by the aggregate properties. In order to be workable, concrete mixtures must contain enough paste to coat the surface of each aggregate particle. Excessive water in the paste, however, reduces concrete durability by reducing strength and increasing permeability. It is important to achieve optimum water content. This, too, can largely be accomplished by selecting the optimum aggregate size and grading. Smaller (finer) aggregates require more paste because they have higher specific surface areas. In natural sands, it is common for much of the very fine (i.e., #100 sieve) particles to be clay, with extremely high specific surface areas. Therefore, the amount of such fine materials is limited in specifications. Crushed fine aggregate is less likely to contain clay particles, and consideration may be given to permitting slightly higher dust contents.

Finally, mixtures containing well-graded aggregate generally will have less shrinkage and permeability, will be easier to handle and finish, and will be the most economical.

The use of gap-graded (single-sized) aggregate, on the other hand, can result in mixtures that segregate and require more water to achieve workability. Very fine sands are often uneconomical; they may increase water demand in the mixture and can make entraining air difficult. Very coarse sands and coarse aggregate can produce harsh, unworkable mixtures. In general, aggregates that do not have a large deficiency or excess of any size (they will give a smooth grading curve) will produce the most satisfactory results.

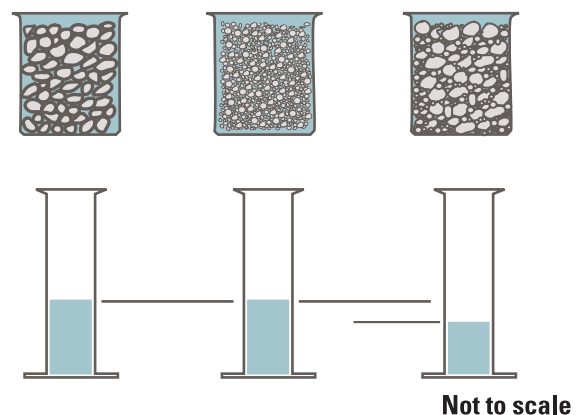

PCA, used with permission

Figure 4-9. Well-graded aggregate with a balanced variety of sizes allows smaller particles to fill voids between larger particles, maximizing aggregate volume

Consistent Grading Is Critical

Variations in aggregate grading between batches can seriously affect the uniformity of concrete from batch to batch.

Fine-Aggregate Grading Requirements

ASTM C33/C33M and AASHTO M 6 permit a relatively wide range in fine-aggregate gradation. In general, if the w/cm ratio is kept constant and the ratio of fine-to-coarse aggregate is chosen correctly, a wide range in grading can be used without a measurable effect on strength. However, it may be most economical to adjust the proportions of fine and coarse aggregate according to the gradation of local aggregates.

In general, increasing amounts of fine material will increase the water demand of concrete. Fine-aggregate grading within the limits of ASTM C33/C33M and AASHTO M 6 is generally satisfactory for most concretes. The amounts of fine aggregate passing the #50 and #100 sieves affect water demand, workability, surface texture, air content, and bleeding of concrete. Large amounts of fine material may increase the water demand and increase stickiness; whereas, insufficient fines could result in bleeding. Most specifications allow 5 to 30 percent to pass the #50 sieve.

Other requirements of ASTM C33/C33M and AASHTO M 6 are as follows:

- The fine aggregate must not have more than 45 percent retained between any two consecutive standard sieves.
- The fineness modulus (FM) must be not less than 2.3, nor more than 3.1, nor vary more than 0.2 from the typical value of the aggregate source. If this value is exceeded, the fine aggregate should be rejected unless suitable adjustments are made in the proportions of fine and coarse aggregate.

The FM is a measure of the fineness of an aggregate—the higher the FM, the coarser the aggregate. According to ASTM C125, the FM is calculated by adding the cumulative percentages by mass retained on each of a specified series of sieves and dividing the sum by 100. The specified sieves for determining FM are #100, #50, #30, #16, #8, #4, $\frac{3}{8}$ in., $\frac{3}{4}$ in., $1\frac{1}{2}$ in., 3 in., and 6 in.

Fineness modulus is not a unique descriptor, and different aggregate gradings may have the same FM.

However, the FM of fine aggregate can be used to estimate proportions of fine and coarse aggregates in concrete mixtures.

Coarse-Aggregate Grading Requirements

The coarse-aggregate grading requirements of ASTM C33/C33M and AASHTO M 80 also permit a wide range in grading and a variety of grading sizes. As long as the proportion of fine aggregate to total aggregate produces concrete of good workability, the grading for a given maximum-size coarse aggregate can be varied moderately without appreciably affecting a mixture's cement and water requirements. Mixture proportions should be changed if wide variations occur in the coarse-aggregate grading.

The maximum coarse-aggregate size to be selected is normally limited by the following: local availability, a maximum fraction of the minimum concrete thickness or reinforcing spacing, and ability of the equipment to handle the concrete.

Combined-Aggregate Grading

The most important grading is that of the combined aggregate in a concrete mixture (Abrams 1924). Well-graded aggregate, indicated by a smooth grading curve (Figure 4-10), will generally provide better performance than a gap-graded system. Crouch (2000) found in his studies on air-entrained concrete that the ratio of w/cm could be reduced by more than 8 percent using combined aggregate gradation.

Combinations of several aggregates in the correct proportions will make it possible to produce a combined aggregate grading that is close to the preferred envelope. Sometimes mid-sized aggregate, around the $\frac{3}{8}$ in. size, is not available, resulting in a concrete with high particle interference, high water demand, poor workability, poor placeability, and high shrinkage properties.

A perfect gradation does not exist in the field, but you can try to approach it by blending the available materials in optimized proportions. If problems develop due to a poor gradation, consider using alternative aggregates, blending aggregates, or conducting a special screening of existing aggregates.

Tools that can be used to evaluate the grading of a combined system are available ([see Aggregate Grading Optimization in Chapter 7](#) and the [Combined Grading test method in Chapter 9](#)). These include the Tarantula curve and coarseness and workability factors, along with the 0.45 power curve.

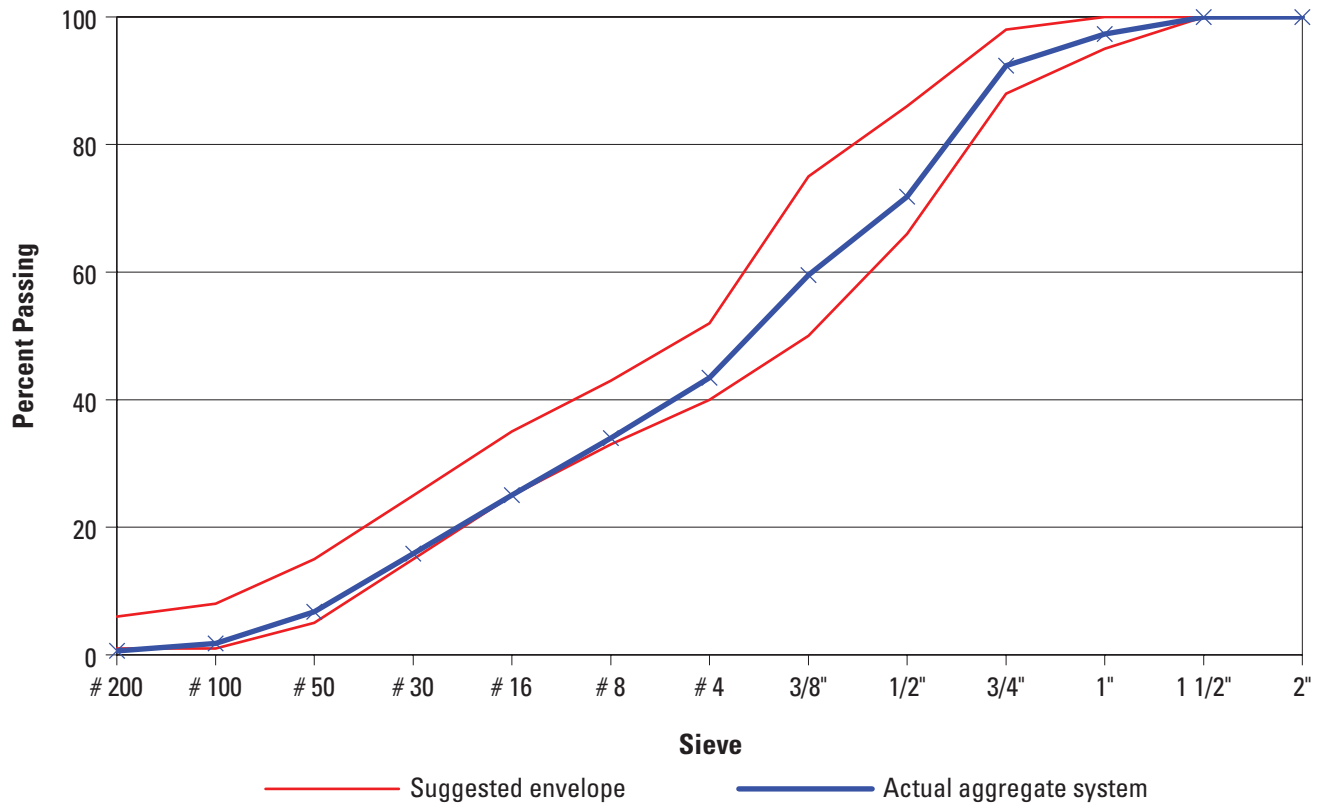

Figure 4-10. Example of a smooth grading curve that would be preferred

Aggregate Particle Shape

Aggregate particles are described as being cubic, flat, or elongated. Aggregate of any shape can be used in concrete to obtain high strength and durability, provided the quantity of mortar at a given w/cm ratio is adjusted. However, keep in mind some rules of thumb:

- In pavements, angular particles lead to higher flexural strengths due to aggregate interlock.
- Angular, nonpolishing fine aggregate particles promote high skid resistance, although they also reduce workability.
- Angular, flat, or elongated particles may reduce concrete workability due to particle interference while in the plastic state. This is especially true of particles between the 3/8 in. and #8 sieves.

Aggregate Surface Texture

Aggregate with any texture, varying from smooth to rough, can be used in portland cement concrete, provided the mixture is properly proportioned. A rough texture may lead to higher strengths due to a better bond.

Aggregate Absorption

In terms of aggregates, absorption is the penetration and retention of water in aggregate particles. The amount of water added to the concrete mixture at the batch plant must be adjusted for the moisture absorbed by the aggregates in order to accurately meet the water requirement of the mixture design. If not accounted for, water expected to absorb from the concrete mixture into aggregate will remain available to hydrate cement, effectively increasing the w/cm ratio, which may ultimately reduce concrete durability.

No Local Source of Well-Graded Aggregate?

If a well-graded system of aggregates is not available from local sources, satisfactory concrete can still be made and placed, but it will require more attention to detail in the construction phase.

The moisture conditions of aggregates (Figure 4-11) are designated as follows:

- Oven dry—fully absorbent
- Air dry—dry at the particle surface but containing some interior moisture, thus still somewhat absorbent
- Saturated surface dry (SSD)—neither absorbing water from nor contributing water to the concrete mixture
- Damp or wet—containing an excess of moisture on the surface (free water)

Absorption values for various types of aggregate range from virtually zero to more than 7 percent of the dry aggregate mass for natural aggregates, and up to 20 percent for lightweight or manufactured materials. However, the absorption values of most aggregates range from 0.2 to 4 percent by mass.

Using aggregates with high absorption values often results in large variations in concrete quality because of the difficulties controlling the aggregates' moisture content. Aggregates that are less than SSD will absorb water from the paste, making the concrete stiffen and lose workability if not accounted for. This effect is reduced when probes are used to monitor the moisture of the aggregates in storage and when the water in the concrete mixture is adjusted to accommodate the difference between the actual moisture content and the SSD condition (see Moisture/Absorption Correction in Chapter 7 and Stockpile Management and Batching under Concrete Production in Chapter 8).

Aggregate Coefficient of Thermal Expansion

A material's CTE is a measure of how much the material changes in length (or volume) for a given change in temperature. Typically, an increase in temperature will result in expansion and a decrease will result in contraction. Because aggregates make up a majority of a concrete's volume, the CTE of the aggregate particles will dominate the CTE for the concrete overall (AASHTO T 336).

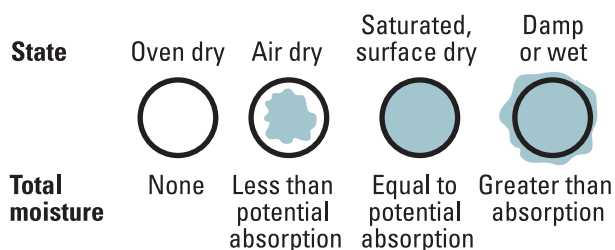

Kosmatka and Wilson 2016, © 2016 PCA, used with permission

Figure 4-11. Moisture conditions of aggregates

CTE values are considered in design calculations for pavements (NCHRP 2004) and are used in thermal modeling of concretes. Limestone and marble have the lowest, and therefore most desirable, thermal expansions. Table 4-10 shows some typical linear CTE values of concrete made with several aggregates.

Aggregate Durability

One of the reasons concrete pavements are economically desirable is their long service life relative to pavements made from other systems. To achieve the desired service life, it is important to ensure that pavements are as durable as possible. Some of the aggregate mechanisms related to reduced pavement durability include alkali-aggregate reactivity, frost resistance, thermal expansion, and abrasion resistance.

Aggregate Durability and Alkali-Aggregate Reactivity

Aggregates containing certain minerals (Table 4-11) can react with alkali hydroxides in concrete to form a gel that expands when exposed to moisture. This reaction and expansion eventually results in cracking in the aggregate and the concrete (Figure 4-12).

Reactive minerals are often found in specific types of rocks (Table 4-11), which in turn may or may not be reactive, depending on the exact makeup of the rock (Table 4-12). The reactivity is potentially harmful only when it produces significant expansion.

Table 4-10. Typical CTE values for some aggregates

Primary aggregate class	Coefficient of thermal expansion
	Average (10 ⁻⁶ /°F)
Andesite	4.32
Basalt	4.33
Chert	6.01
Diabase	4.64
Dolomite	4.95
Gabbro	4.44
Gneiss	4.87
Granite	4.72
Limestone	4.34
Quartzite	5.19
Rhyolite	3.84
Sandstone	5.32
Schist	4.43
Siltstone	5.02

Source: Hall and Tayabji 2011

Table 4-11. Mineral constituents of aggregate that are potentially alkali-reactive

Alkali-reactive mineral	Potentially deleterious amount
Optically strained, microfractured or microcrystalline quartz	More than 5%
Chert or chalcedony	More than 3%
Trydimite or cristobalite	More than 1%
Opal	More than 0.5%
Natural volcanic glass	More than 3%

Source: Kosmatka and Wilson 2016

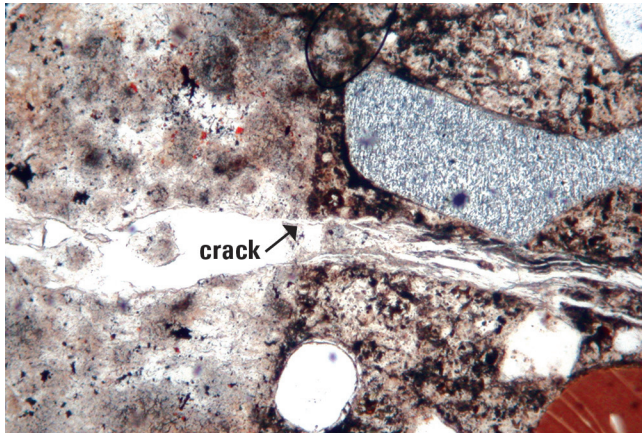

PCA, used with permission

Figure 4-12. Aggregate particle that has cracked due to alkali-silica reaction

Table 4-12. Rock types potentially susceptible to alkali-silica reactivity

Rock types
Arenite
Argillite
Arkose
Chert
Flint
Gneiss
Granite
Graywacke
Hornfels
Quartz-arenite
Quartzite
Sandstone
Shale
Silicified carbonate
Siltstone

Source: Folliard et al. 2003

Alkali-aggregate reactivity has two forms—ASR and ACR. For more information, see Kosmatka and Farny (1997), Folliard et al. (2003), and Thomas et al. (2013).

ASR is much more common than ACR. The best way to avoid ASR is to take appropriate precautions before concrete is placed. Expansion tests (ASTM C1260, AASHTO T 303, and ASTM C1293) and petrography (ASTM C295/C295M) are the most commonly used methods to determine the potential susceptibility of an aggregate to ASR if the performance of the aggregate in the field is not available. (These and other tests and methods for controlling ASR are discussed in detail under [Alkali-Silica Reaction in Chapter 6](#).)

The only means to prevent ACR is to avoid using the reactive aggregate. If this is not feasible, then dilute the aggregate with nonreactive stone (Ozol 1994).

Aggregate Durability and Frost Resistance

Concrete containing aggregates that are not frost resistant may experience D-cracking, popouts, or deterioration from deicing salts.

D-Cracking

Freeze-thaw deterioration of aggregate is associated with the freezing and thawing of susceptible, coarse aggregate particles in the concrete. This resulting pavement distress is commonly referred to as D-cracking. Aggregates identified as being D-cracking susceptible trap water and either fracture as they freeze and then dilate greatly (resulting in cracking of the surrounding mortar) or allow for rapid expulsion of water during freezing, which contributes to dissolution of soluble paste components at the aggregate-paste interface. Key aggregate properties related to D-cracking susceptibility are aggregate size, pore size distribution, and aggregate strength (Mindess et al. 2003). D-cracking is generally a regional problem caused when locally available, susceptible aggregate is used in concrete.

D-cracks are easy to identify. They are closely spaced cracks parallel to transverse and longitudinal joints (where the aggregate is most likely to become saturated). Over time, the cracks multiply outward from the joints toward the center of the pavement slab (Figure 4-13).

D-cracking is a serious problem that will compromise the integrity of concrete. It cannot be stopped or undone; it can only be prevented. Therefore, when designing a mixture it is critical to select aggregates that are not susceptible to freeze-thaw deterioration.



Jim Grove, ATI Inc./FHWA, used with permission

Figure 4-13. D-cracking

If marginal aggregates must be used, you may be able to reduce D-cracking susceptibility or delay the occurrence of distress by reducing the maximum particle size and by providing good drainage for carrying water away from the pavement base.

Popouts

A popout is usually a conical fragment that breaks out of the surface of concrete, leaving a shallow, typically conical, depression (Figure 4-14). Generally, a fractured aggregate particle will be found at the bottom of the hole with the other part of the aggregate still adhering to the point of the popout cone. Most popouts are about 1 to 2 in. wide; however, popouts caused by sand particles are much smaller, and very large popouts may be up to 1 ft in diameter.

Unless they are very large, popouts are only a cosmetic flaw and do not generally affect the service life of the concrete.

Popouts may occur in concretes where the surface contains small amounts of coarse (rather than fine) aggregate particles with higher porosity values and medium-sized pores 0.1 to 5 μm that are easily saturated. Larger pores do not usually become saturated



Figure 4-14. Popout at the concrete surface

or cause concrete distress, and water in very fine pores does not freeze readily. As the offending aggregate absorbs moisture and freezing occurs, the swelling creates enough internal pressure to rupture the concrete surface. Sometimes, all that is needed for expansion to occur is a season of high humidity.

Aggregates containing appreciable amounts of shale, soft and porous materials (clay lumps, for example), and certain types of chert may be prone to popouts. These particles are often of lighter weight and can float to the surface under excessive vibration. This will increase the number of popouts, even when the amount of these particles is small or within specification limits. Specifications for concrete aggregates, such as ASTM C33/C33M, allow a small amount of deleterious material because it is not economically practical to remove all of the offending particles.

The presence of weak, porous particles in the aggregate can be reduced by jiggling, heavy-media separation, or belt picking; however, these methods may not be available or economical in all areas.

Salt (Sulfate) Susceptibility

Certain aggregates such as ferroan dolomites are susceptible to damage by salts. These aggregates may exhibit excellent freeze-thaw resistance but deteriorate rapidly when deicing salts are used. In the presence of salts, the crystalline structure of such aggregates is destabilized, therefore increasing the rate of damage under freeze-thaw conditions.

Aggregate Durability and Abrasion Resistance

An important property of pavements is their ability to provide an adequate skid resistance by resisting abrasion or resisting wear. The abrasion resistance of concrete is related to both aggregate type and concrete compressive strength (Figure 4-15).

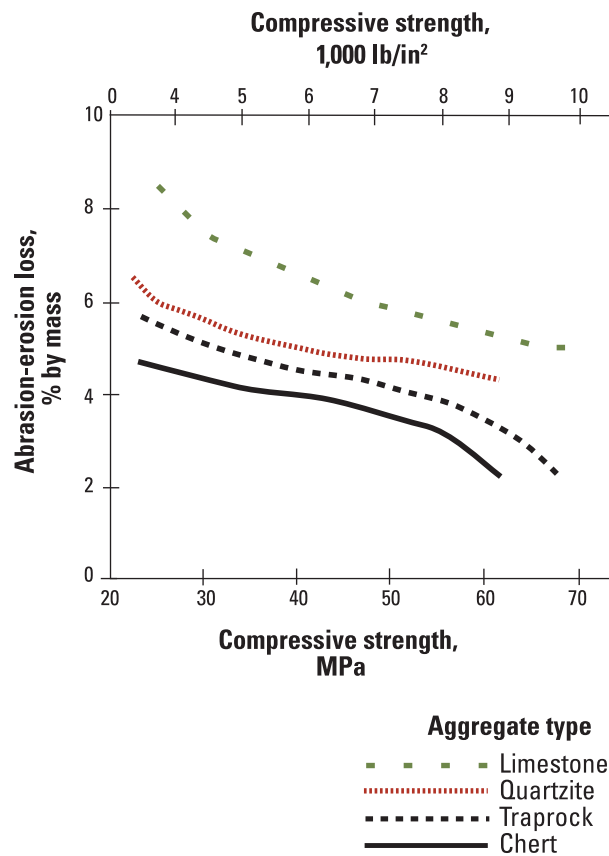

Figure 4-15. Effect of compressive strength and aggregate type on the abrasion resistance of concrete using ASTM C1138

Strong concrete has more resistance to abrasion than does weak concrete, while hard aggregate is more wear resistant than soft aggregate. In other words, high-strength concrete made with a hard aggregate is highly resistant to abrasion (Liu 1981). The use of natural sands in concrete mixtures will improve abrasion resistance and can result in improved abrasion resistance of concrete, even when soft coarse aggregates are used.

The abrasion resistance of an aggregate can be used as a general indicator of its quality. Using aggregate with low abrasion resistance may increase the quantity of fines in the concrete during mixing and consequently may increase the water requirement. In general, siliceous aggregates are more resistant to abrasion than calcareous (acid-soluble) materials. As a result, some specifications limit the amount of calcareous material in aggregate to ensure adequate abrasion resistance (see [Abrasion Resistance in Chapter 6](#)).

Coarse aggregate abrasion resistance is usually measured using the Los Angeles (LA) abrasion test method (ASTM C535 and ASTM C131/C131M). The Micro-Deval test, developed in France during the 1960s, is an alternative to the LA abrasion test (Kandhal and Parker 1998).

Water

Key Points

- Mixing water can consist of batch water, ice, free moisture on aggregates, water in admixtures, and water added after initial mixing.
- Ideally, water for concrete should be potable (fit for human consumption).
- Some water recycled from returned concrete and plant washing can be acceptable.
- Questionable mixing water should be tested for its effect on concrete strength and setting time.
- The specification for mixing water in concrete mixtures is ASTM C1602/C1602M.

This section focuses on water sources and quality. (For information about achieving the optimum quantity of water in concrete mixtures, see [Calculating Mixture Proportions in Chapter 7](#). Concrete mixtures must contain enough paste [cement and water] to coat the aggregates and to make the mixture workable. Too much water reduces long-term concrete durability. It is critical to achieve optimum water content for each specific mixture and project.)

Sources of Water in the Mixture

Water discharged into the mixer is the main, but not the only, source of mixing water in concrete:

- During hot weather concreting, ice may be used as part of the mixing water to cool the concrete. The ice should be completely melted by the time mixing is completed.
- Aggregates often contain surface moisture, and this water can represent a substantial portion of the total mixture water. Therefore, it is important that the water brought in by the aggregate is free from harmful materials and accounted for when batching concrete ingredients.
- Water contained in admixtures also represents part of the mixture water if it affects the mixture's w/cm ratio by 0.01 or more.

Mixture Water and Aggregate Moisture

To account for mixture water properly, you need to know the moisture condition of aggregates used in the mixture design. In the trial batch and at the beginning of construction, you may need to adjust water content based on the actual moisture condition of the aggregates used. For more information, see [Moisture/Absorption Correction in Chapter 7](#) and [Stockpile Management and Batching under Concrete Production in Chapter 8](#).

Water Quality

The quality of water used in concrete mixtures can play a role in the quality of concrete. Excessive impurities in mixing water may affect setting time and concrete strength and can result in salt deposits on the pavement surface, staining, corrosion of reinforcement materials, volume instability, and reduced pavement durability.

Many state DOTs have specific requirements for mixing water in concrete. In general, suitable mixing water for making concrete includes the following:

- Potable water
- Nonpotable water
- Recycled water from concrete production operations

Both nonpotable water and recycled water must be tested to ensure they do not contain impurities that negatively affect concrete strength, set time, or other properties. Water containing less than 2,000 parts per million (ppm) of total dissolved solids can generally be used satisfactorily for making concrete. Water containing organic materials or more than 2,000 ppm of dissolved solids should be tested for its effect on strength and time of set (Kosmatka 2016).

Table 4-13. Acceptance criteria for combined mixing water

	Limits	Test methods
Compressive strength, minimum % control at 7 days*,**	90	ASTM C31 / ASTM C31M, ASTM C39 / ASTM C39M
Time of set, deviation from control (h:min*)	From 1:00 early to 1:30 later	ASTM C403 / ASTM C403M

* Comparisons shall be based on fixed proportions for a concrete mix design representative of questionable water supply and a control mix using 100% potable water or distilled water.

** Compressive strength results shall be based on at least two standard test specimens made from a composite sample.

Water of questionable suitability can be used for making concrete if concrete cylinders (ASTM C39/C39M and AASHTO T 22) or mortar cubes (ASTM C109/C109M and AASHTO T 106) made with it have seven-day strengths equal to at least 90 percent of companion specimens made with potable or distilled water. Setting time tests should be conducted to ensure that impurities in the mixing water do not adversely shorten or extend the setting time of concrete (ASTM C403/C403M and AASHTO T 197) or cement (ASTM C191 and AASHTO T 131). In addition, the density of the water (ASTM C1603) has to be tested if water from concrete production operations or water combined from two or more sources is to be used as mixing water. Acceptance criteria for water to be used in concrete are given in ASTM C1602/C1602M and AASHTO T 26 (Table 4-13).

Optional limits may be set on chlorides, sulfates, alkalis, and solids in the mixing water (Table 4-14), or appropriate tests should be performed to determine the effect the impurity has on concrete properties. Some impurities may have little effect on water requirement, strength, and setting time while adversely affecting concrete durability and other properties.

Recycled Water

Recycled water is primarily a mixture of water, admixtures, cementitious materials, and aggregate fines resulting from processing returned concrete. Recycled water may also include truck wash water and stormwater from the concrete plant. Usually, recycled water is passed through settling ponds where the solids settle out, leaving clarified water. In some cases, recycled water from a reclaimer unit is kept agitated to maintain the solids in suspension for reuse as a portion of the batch water in concrete (Figure 4-16). Solid content in recycled water varies from 2.5 to 10 percent by mass.

Table 4-14. Optional chemical limits for combined mixing water

	Limits	Test methods
Maximum concentration in combined mixing water, ppm*		
A. Chloride (Cl ⁻), ppm		
1. In prestressed concrete, bridge decks, or otherwise designated	500**	ASTM C114
2. Other reinforced concrete in moist environments or containing aluminum embedments or dissimilar metals or with stay-in-place galvanized metal forms	1,000**	ASTM C114
B. Sulfate (SO ₄), ppm	3,000	ASTM C114
C. Alkalies (Na ₂ O + 0.658 K ₂ O), ppm	600	ASTM C114
D. Total solids by mass, ppm	50,000	ASTM C1603

* ppm is the abbreviation for parts per million

** The requirements for concrete in ACI 318 shall govern when the manufacturer can demonstrate that these limits for mixing water can be exceeded. For conditions allowing the use of calcium chloride (CaCl₂) accelerator as an admixture, the chloride limitation is permitted to be waived by the purchaser

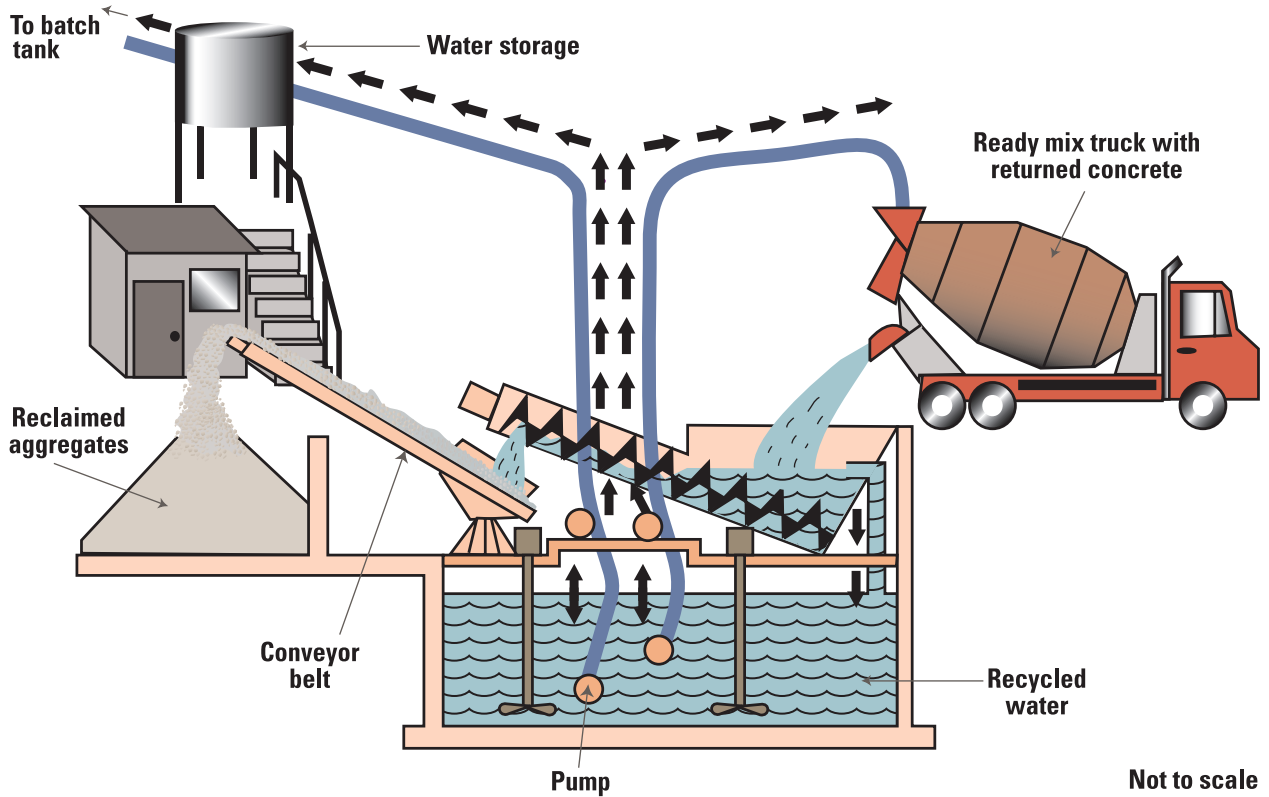

Kosmatka and Wilson. 2016, © 2016 PCA, used with permission

Figure 4-16. Recycled water and reclaimed aggregate at a ready-mixed concrete plant

Using recycled water in concrete mixtures may affect the water requirement, setting time, strength, and permeability of concrete. ASTM C1602/C1602M and AASHTO M 157 permit the use of wash water as concrete mixture water, with approval from the purchaser who can invoke chemical limits for chlorides, sulfates, alkalis, and solids. The maximum permitted solids content is 50,000 ppm, or 5 percent, of the total mixing water. This amounts to about 15 lb/yd³

solids in a typical concrete mixture. A solids content of approximately 50,000 ppm represents water with a relative density (specific gravity) of 1.03. Research at the National Ready Mixed Concrete Association (Lobo and Mullings 2003) identified several important effects of using recycled water on properties of concrete in comparison to control concrete mixtures made with tap water (Figure 4-17).

Recycled water with	Water demand	Setting time	Compressive strength	Permeability	Freeze-thaw resistance
Solid contents within ASTM C94 limits (≤ 15 lb/yd ³)	↔	↔	↔	↔	↔
High solid contents (> 15 lb/yd ³)	↑	↓	↓*	↑*	↔
High solid contents and treated with hydration stabilizing admixture	↔	↔	↔	no data	no data

Compared to reference concrete with tap water
*Strength and permeability effects were related to increased mixing water content.

Key: ↓ decreased
↑ increased
↔ no trend

Source: After Lobo and Mullings 2003

Figure 4-17. Effect of recycled water on concrete properties

Chemical Admixtures

Key Points

- Admixtures are materials added to concrete mixtures to modify concrete properties such as air content, water requirement, and setting time. Admixtures should complement, not substitute for, good concrete proportioning and practice.
- Admixtures may have unintended side effects. Therefore, run trial batches with job materials and under job conditions.
- Generally, for every 1 percent entrained air, concrete loses about 5 percent of its compressive strength.
- Air-entraining admixtures are specified by ASTM C260/C260M. Water-reducing and set-modifying admixtures are specified by ASTM C494/C494M and AASHTO M 194.
- For information about possible incompatibilities of various chemical admixtures, [see the section on Potential Materials Incompatibilities in Chapter 5.](#)

Chemical admixtures are added to concrete during mixing to modify fresh or hardened concrete properties such as air content, workability, or setting time.

Table 4-15 lists common admixtures used in concrete for pavements. Table 4-16 lists admixtures specified under ASTM C494/C494M and AASHTO M 194.

Table 4-15. Common chemical admixture types for paving applications

Class	Function
Air-entraining admixture (AEA)	Stabilize microscopic bubbles in concrete, which can provide freeze-thaw resistance and improve resistance to deicer salt scaling
Water-reducing admixture (WR)	Reduce the water content by 5% to 10%, while maintaining slump characteristics
Mid-range water reducer (MRWR)	Reduce the water content by 6% to 12%, while maintaining slump and avoiding retardation
High-range water reducer (HRWR)	Reduce the water content by 12% to 30%, while maintaining slump
Retarder	Decrease the rate of hydration of cement
Accelerator	Increase the rate of hydration of cement

Table 4-16. Admixture types defined by ASTM C494/AASHTO M 194

Class	Name
Type A	Water reducing
Type B	Retarding
Type C	Accelerating
Type D	Water reducing and retarding
Type E	Water reducing and accelerating
Type F	Water reducing, high range
Type G	Water reducing, high range, and retarding

Air-entraining admixtures are specified by ASTM C260/AASHTO M 154, and superplasticizers are specified by ASTM C1017.

Adding chemical admixtures may help concrete designers achieve desired concrete properties more efficiently or economically than adjusting other ingredients or mixture proportions. Admixtures are also used to maintain specific properties during concreting operations or under unusual conditions. However, admixtures should not be used as a substitute for good concrete practice. They should be used to enhance good concrete, not to fix bad concrete. Chemical admixtures may have unintended side effects that must be accommodated.

An admixture's effectiveness depends on many factors, including cementitious materials properties, water content, aggregate properties, concrete material proportions, mixing time and intensity, and temperature.

Common admixtures are air-entraining, water-reducing, and set-modifying admixtures.

Air-Entraining Admixtures

Air-entraining agents are the most commonly used chemical admixtures in concrete. They are typically derived from pine wood resins, vinsol resins, and other synthetic detergents.

Specifications and methods of testing AEAs are given in ASTM C260/C260M, AASHTO M 154, ASTM C233/C233M, and AASHTO T 157. Applicable requirements for air-entraining portland cements are given in ASTM C150/C150M and AASHTO M 85 and for air-entraining blended cements in ASTM C595/C595M and AASHTO M 240.

Function of Air Entrainment in Concrete

Stabilized air bubbles in hardened concrete are called air voids or entrained air. Concrete with proper air entrainment contains a uniform distribution of small, stable bubbles, or air voids, throughout the cement paste (Figure 4-18). Proper air entrainment will do the following:

- Dramatically improve the durability of concrete exposed to moisture during cycles of freezing and thawing
- Improve concrete's resistance to surface scaling caused by chemical deicers
- Tend to improve the workability of concrete mixtures, reduce water demand, and decrease mixture segregation and bleeding

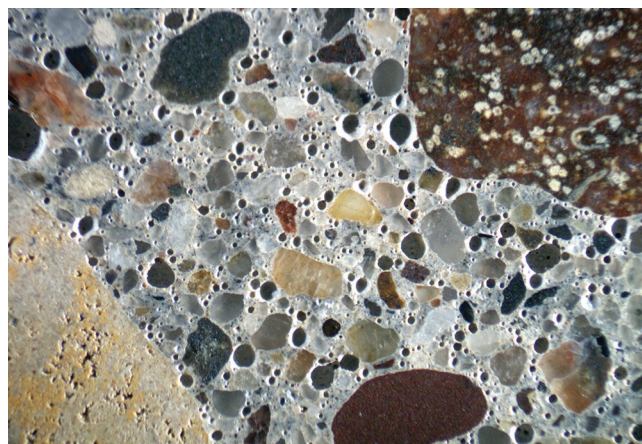

*Length of field scale: left to right = 0.49 in.; top to bottom = 0.37 in.
Ron Sturm, Braun Intertec, used with permission*

Figure 4-18. Entrained air bubbles in concrete

An air-void system consisting of many smaller, closely spaced voids provides the greatest protection against freeze-thaw damage (Figure 4-19). The air-void system is characterized by three different measurements. The air content is the total volume of air in the concrete mixture, excluding air voids in aggregate. The spacing factor is a parameter related to the maximum distance in the cement paste from the periphery of an air void; the unit is length (ASTM C457, 2016). The specific surface is an estimate of the true specific surface area of the air-void system, expressed in units of reciprocal length. In fresh concrete, the air content is measured by tests such as ASTM C231/C231M and AASHTO T 152. In hardened concrete, all three measurements are made in accordance with ASTM C457/C457M. The spacing factor is generally used as the measure of freezing and thawing durability. A value of less than or equal to 0.008 in. is desired. A recent development for measuring the air-void system parameter is AASHTO TP 118, also called the SAM meter. This test results in a SAM number that correlates with freezing and thawing durability in a manner comparable to the spacing factor.

Air-Entraining Agent Mechanisms

By causing a soap-like coating to form around the air bubbles, AEAs stabilize millions of tiny air bubbles in the concrete mixture that were created by the concrete mixing action. Molecules of air-entraining agent are attracted to water at one end and to air at the other end, reducing surface tension at the air-water interface; the ends that protrude into water are attracted to cement particles (Figure 4-20). It is critical that sufficient mixing time be allowed for the air bubbles to be generated and stabilized.

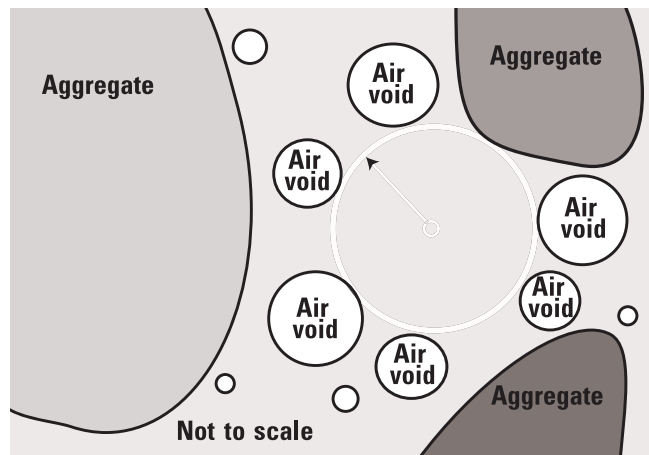

Celik Ozyildirim

Figure 4-19. Spacing factor is the average distance from any point to the nearest air void

The air-void system will be affected by the type/ amount of air-entraining agent, mixing time, placement methods, carbon impurities from SCMs or aggregates, and other reactive materials in the mixture, including water-reducing admixtures. For example, mixtures with high-range water-reducing admixtures show a shift toward larger void sizes (Whiting and Nagi 1998).

How Entrained Air Improves Concrete Freeze-Thaw Resistance

Entrained air plays a critical role in improving concrete pavements' durability by reducing their susceptibility to freeze-thaw damage.

When most of the cement in a concrete mixture has reacted with water in the mixture, some of the remaining water is lost to evaporation, leaving behind capillary pores. Any remaining water can move through these pores. If the temperature drops below freezing, water in capillary pores turns to ice and expands. As the freezing and expanding water forces unfrozen water through the pores, it exerts pressure on the surrounding hardened cement paste. Entrained air voids act as a pressure-relief valve, providing space for the water/ice to expand and relieve pressure on the surrounding concrete. Without adequate air voids, the pressure may cause the hardened cement paste to crack, initiating early pavement deterioration.

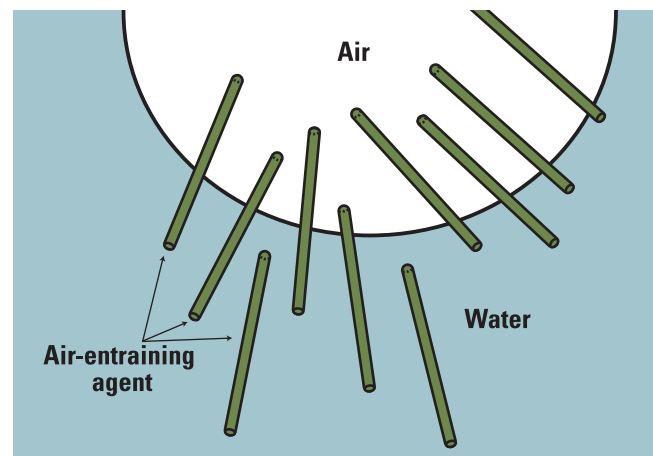

PCA, used with permission

Figure 4-20. Stabilization of air voids by air-entraining admixture molecules

Figure 4-21 lists trends of the effects of concrete ingredients and production on air entrainment. The extent of the changes will depend on specific materials, practices, and equipment. This diagram may suggest ways to correct high or low air contents.

If you do not have prior experience with the specific job materials and job equipment, prepare a trial mixture to determine the proper quantity and minimum mixing time.

Material/practice	Change	Effect
Cement	Increase in cement content	↓
	Increase in fineness	↓
	Increase in alkali content	↑
Supplementary cementitious materials	Fly ash (especially with high carbon)	↓↓
	Silica fume	↓↓
	Slag with increasing fineness	↓
	Metakaolin	↔
Aggregates	Increase in maximum size	↓
	Sand content	↑
Chemical admixtures	Water reducers	↑
	Retarders	↑
	Accelerators	↔
	High-range water reducers	↑
w/cm	Increase w/cm	↑
Slump	Increase in slump up to 6 in.	↑
	High slump (>6 in.)	↓
	Low slump concrete (< 3 in.)	↓
Production	Batching	↑ ↓
	Increased mixer capacity	↑
	Mixer speeds to 20 rpm	↑
	Longer mixer time	↑
Transport and delivery	Transport	↓
	Long hauls	↓
	Retempering	↑
Placing and finishing	Belt conveyers	↓
	Pumping	↓↓
	Prolonged internal vibration	↓
	Excessive finishing	↓

Key: ↓ decrease in air content
 ↓↓ significant decrease
 ↑ increase in air content
 ↔ no significant change
 ↑ ↓ increase or decrease in air content

Source: Thomas and Wilson 2002

Figure 4-21. Effects of materials and practices on air entrainment

Side Effects of Air-Entraining Admixtures

Generally, for every 1 percent entrained air, concrete loses about 5 percent of its compressive strength, everything else being equal (Whiting and Nagi 1998). However, this loss of strength can generally be mitigated by adjusting the w/cm ratio of the mixture. With non-vinsol AEAs, air voids may coalesce around aggregates, leading to reduced concrete strength (Cross et al. 2000) (see *Air-Void System Incompatibilities in Chapter 5*). This result tends to occur in concrete with higher air contents that have had water added after initial mixing, and it may also be affected by the type of aggregate.

Water Reducers

Water reducers are the second most commonly used chemical admixtures. A summary of the various classes is given in *Table 4-16*. Mid-range products are generally a combination of natural, petroleum-based, and/or polycarboxylate chemical compounds (see the callout box, *Three Generations of Water-Reducing Admixtures*, on the following page). Types F and G water reducers are not normally used in pavements because of their high cost and because it is difficult to control the slump range required for slipform paving with their use.

Function of Water Reducers

You will remember that more water than is needed for cement hydration must be added to concrete mixtures to make them workable. Too much water, however, can reduce concrete durability by increasing porosity and permeability in the hardened concrete, allowing aggressive chemicals to penetrate the pavement. Water reducers are therefore added to mixtures to reduce the amount of water needed to maintain adequate workability in plastic concrete.

Water-reducing admixtures also indirectly influence concrete strength. For concretes of equal cement content, air content, and slump, the 28-day strength of a water-reduced concrete can be 10 percent greater than of concrete without such an admixture. Water-reducing admixtures are specified by ASTM C494/C494M and AASHTO M 194.

The effectiveness of water reducers on concrete is a function of their chemical composition, concrete temperature, cementitious material content and properties, and the presence of other admixtures. Typical ranges of water reduction and slump are shown in *Table 4-15*.

High-range water reducers (HRWRs) (Types F and G, also called superplasticizers) can be used to reduce necessary water content by 12 to 30 percent. In older products, however, the rate of slump loss is not reduced and in most cases is increased. Newer generation HRWRs do not exhibit as rapid a rate of slump loss. Rapid slump loss results in reduced workability and less time to place concrete. High temperatures can also aggravate slump loss. Some modern Type F water-reducing admixtures may entrain air, meaning that less AEA will be required.

Three Generations of Water-Reducing Admixtures

First-generation water-reducing admixtures were primarily derived from natural organic materials such as sugars and lignins (extracted from wood pulp). These products had a limited effectiveness and may have been somewhat variable in performance, depending on the source material. These water reducers would often retard the mixture, particularly when used in excess. They are still used as Type A, B, and D products.

Second-generation (early high-range) water-reducing admixtures were derived from petroleum feedstocks—sulfonated naphthalene or melamine condensates with formaldehyde. These products offer greater water reduction and are less detrimental when used in excess. They often only provide about 20 minutes of effectiveness before the concrete exhibits significant slump loss. These products can be redosed after this time to maintain workability, if required.

Third-generation water-reducing admixtures are polycarboxylates, which are copolymers synthesized from carefully selected monomers. These products are currently used in mid- or high-range water-reducing admixtures (Types F and G). These admixtures can be fine-tuned for a given application, including a range of effectiveness and setting times. They may also increase air entrainment.

Water-Reducing Agent Mechanisms

Water reducers operate predominantly by applying surface charges on cement particles, which break up agglomerations of particles. As the cement particles break up and move apart, trapped water is made available for hydration (Figure 4-22). Some polycarboxylate-based water reducers also use a steric repulsion effect. These have polymers with long side chains that attach to the surface of cement grains to keep the grains apart physically. Ramachandran (1995) contains more detail on admixture mechanisms.

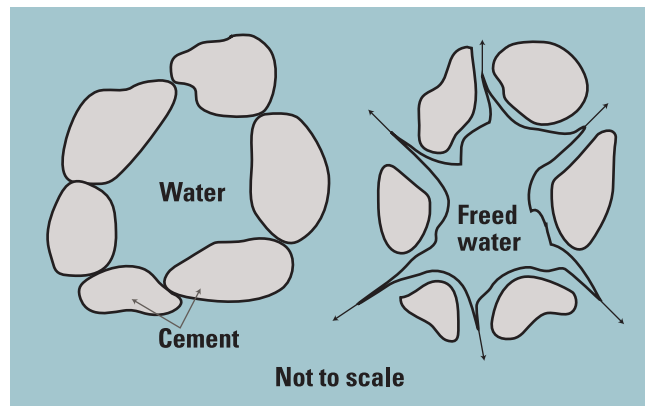

Figure 4-22. One mechanism by which water reducers work is dispersion: charged cement particles cling together, trapping water (left) and water reducers separate cement grains, releasing the water and making it available for hydration (right)

Side Effects of Water Reducers

Polycarboxylate water-reducing admixtures have been reported to increase air entrainment in some cases. Types D, E, and G water-reducing admixtures can significantly affect setting behavior. Excess water reducer additions, particularly normal-range products, may severely retard or prevent setting.

Set-Modifying Admixtures

Admixtures may be used to control (i.e., retard or accelerate) the rate of setting and strength gain of concretes. These effects can be particularly important for hot- and cold-weather concreting operations. They can also be useful for fast-track construction and to control production cycles, permit longer haul times, or compensate for slower strength gain of concretes made with some SCMs.

Chemical admixtures containing calcium chloride (CaCl_2) should not be used in reinforced pavements because of the risk of corrosion of steel.

Retarders are designated as Type B admixtures under ASTM C494/C494M and AASHTO M 194, although retardation is associated with Types D and G as well (Table 4-16).

Accelerators are designated as Type C admixtures under ASTM C494/C494M and AASHTO M 194. Type E admixtures also have accelerating properties.

Primary Function of Set-Modifying Admixtures

Retarding admixtures are used to slow the rate of concrete setting. They may be used during hot-weather paving, when high concrete temperatures often cause an increased rate of stiffening that makes placing and finishing difficult. Retarders chemically control cement hydration, consequently reducing the maximum temperature. Retarders may also be used to delay setting under difficult or unusual placement conditions.

Accelerating admixtures are used to increase the rate of strength development of concrete at an early age, including in cold weather. However, excess acceleration may result in cracking before finishing and/or saw cutting can be completed.

Set-Modifying Agent Mechanisms

The mechanisms by which accelerators and retarders work are complex. However, some retarders appear to form a coating around cement grains that prevents or slows hydration. Eventually, the coating is breached and the hydration resumes.

Some accelerating admixtures, such as calcium chloride, appear to preferentially accelerate hydration of the silicate phases (alite [C_3S] and belite [C_2S]), while others appear to accelerate other phases. For more information, see Ramachandran (1995) and Thomas and Wilson (2002).

Side Effects of Set-Modifying Admixtures

The effects of set-modifying admixtures on other properties of concrete, like shrinkage, may not be predictable. Therefore, acceptance tests of set modifiers should be made with job materials under anticipated job conditions to detect possible side effects:

Set-Retarding Admixtures' Side Effects

Effects may include the following:

- Many retarders also act as water reducers; they are frequently called water-reducing retarders.
- Set-retarding admixtures may increase air content in the mixture.
- Delaying setting of a mixture may increase the risk of plastic shrinkage cracking and may interfere with the saw-cutting window.
- In general, use of retarders may be accompanied by some reduction in strength at early ages (one to three days), but later strengths may be higher.
- With retarders, the bleeding rate and bleeding capacity of concrete are increased.
- Set-retarding admixtures are useful in extending setting times of concrete, but not all are effective in decreasing slump loss and extending workability prior to placement at elevated temperatures (Whiting and Dziedzic 1992).

Set-Accelerating Admixtures' Side Effects

Accelerators like calcium chloride are not antifreeze agents. Precautions should be taken during cold weather to protect the concrete from freezing prior to achieving sufficient strength.

When calcium chloride is used, it should be added to the concrete mixture in solution form as part of the mixture water. If added in dry form, the particles may not completely dissolve. Undissolved lumps in the mixture can cause popouts and dark spots in hardened concrete. Excess calcium chloride can result in placement problems and can cause rapid stiffening, a large increase in drying shrinkage, corrosion of reinforcement, and loss of strength at later ages.

Other Admixtures

Several other admixtures may be used in concrete, including lithium-based materials for mitigating alkali-silica reaction, shrinkage-reducing admixtures, and corrosion inhibitors. More information can be found in Thomas and Wilson (2002), Kosmatka and Wilson (2016), and Ramachandran (1995).

Dowel Bars, Tiebars, and Reinforcement

Key Points

- Dowel bars are placed across transverse joints to provide vertical support and to transfer loads across joints.
- Tiebars are placed across longitudinal joints (centerlines or where slabs meet) to prevent the slabs from separating and to transfer loads across the joints.
- Slab reinforcement may be used in concrete pavements to improve the ability of concrete to carry tensile stresses and to hold tightly together any random transverse cracks that develop in the slab.
- Epoxy-coated tiebars should conform to ASTM A775/A775M and AASHTO M 284, and epoxy-coated dowel bars should conform to AASHTO M 254.

Dowel bars, tiebars, and reinforcement may be used in concrete pavements to help the concrete carry tensile stresses (i.e., stresses that pull the concrete apart) and/or to transfer loads across joints. Collectively, these materials are often called “steel,” although they may be made of other materials.

Additional information can be found under [Dowel Bars and Tiebars in Chapter 8](#).

Dowel Bars (Smooth Bars)

Dowel bars (smooth bars), or simply dowels, are placed in concrete across transverse joints to provide vertical support and to transfer loads across joints. Dowel bars are typically used on heavy truck routes. Dowel bars reduce the potential for faulting, pumping, and corner breaks in jointed concrete pavements (Smith et al. 1990, ACPA 1991).

Dowels are smooth and round or oval. Because they are smooth, they do not restrict the horizontal movement of the slab at the joint related to seasonal expansion and contraction of the slab.

The minimum diameter is 1¼ in., except at construction joints (i.e., headers) in pavements less than 7 in. thick. Dowels should not be used in pavements less than 6 in. thick. (Table 3 in Snyder 2011 lists recommended standard basket heights for various

round dowel diameters.) Dowel sizes of 1 in. and less in heavy-traffic pavements have been shown to cause high bearing stresses on the concrete surrounding the dowel bar, resulting in damage in the concrete around the place the dowel emerges from the side of the slab, known as dowel socketing.

Typical dowel lengths are 18 in., although some 15 in. bars are used. This length is primarily related to the required embedment length on each side of the joint. Most states specify 18 in. long dowel bars with 6 in. of embedment on each side of the joint. This leaves 6 in. in the center of the bar as a tolerance for the sawing of the joint and the formation of the subsequent crack.

A 12 in. spacing between bars is standard, although a 15 in. spacing can be used for lighter-traffic facilities. Dowels are typically placed across the entire length of the joint, primarily for constructability purposes. However, only three or four dowels are needed in each wheel path to sufficiently transfer load from one slab to the next (ACPA 1991); this is common practice when dowels are retrofitted in pavements originally constructed without dowels.

Shapes other than round bars have been tested and installed in limited trials. The most promising is the elliptical dowel, which allows for smaller effective diameter bars with the same bearing capacity as round bars. This reduces the weight and cost of the dowel assembly because of the reduced amount of steel used. Elliptical dowels have been shown to have similar performance to round dowels (Porter 2002).

Other mechanical load-transfer systems include flat (plate) dowels and square dowels, both of which are not typically used in roadway or highway pavements.

Tiebars (Deformed Bars)

Tiebars (deformed bars), or rebar, are placed across longitudinal joints (centerlines or where slabs meet). Tiebars prevent faulting and lateral movement of the slabs and assist with load transfer between slabs. Tiebars are also used to connect edge fixtures such as curbs and gutters to the pavement.

Because tiebars are deformed, they bond to the concrete and do not allow movement (unlike smooth dowel bars, which by design allow such movement). Tiebars thus minimize longitudinal joint opening between slabs and so maintain aggregate interlock.

Tiebar size, spacing, and length vary with the thickness of the pavement, tiebar material, and amount of pavement tied together (Table 4-17).

Table 4-17. Tiebar dimensions and spacings

Slab thickness ~in.	Tiebar size × length, ~in.	Tiebar spacing, ~in.			
		Distance to nearest free edge or to nearest joint where movement can occur			
		~10 ft	~12 ft	~14 ft	~24 ft
5	13M × 24	30	30	30	28
6	13M × 24	30	30	30	23
7	13M × 24	30	30	30	20
8	13M × 24	30	30	30	17
9	16M × 30	35	35	35	24
10	16M × 30	35	35	35	22
11	16M × 30	35	35	34	20
12	16M × 30	35	35	31	18

Source: Adapted from ACI 325.12R

Tiebar sizes and embedment lengths should reflect the actual forces acting in the pavement, not only the working strength of the steel. Specifiers should choose standard manufactured tiebar lengths.

Tiebars should not be placed within 15 in. of transverse joints, or they can interfere with joint movement (ACPA 1991), leading to cracking. This space should increase to 18 in. if the tiebars are longer than 32 in. No more than three lanes should be tied together.

Although corrosion of tiebars is not a common problem, some protection should be provided if deicing salts are going to be used on the pavement. ASTM D3963/D3963M and AASHTO M 284 provide guidelines for such protection in the form of a coating. The coating should be no thicker than 125 to 300 μm or the bonding capacity of the bar is reduced.

Reinforcement

Reinforcement may be used in concrete pavements to improve the ability of concrete to carry tensile stresses and to hold tightly together any random transverse cracks that develop in the slab. Generally, cracking in jointed concrete pavements is controlled by limiting the spacing between joints. When the concrete slab is reinforced, joint spacing can be increased.

Current practice does not generally include any distributed reinforcement in concrete slabs, with the exception of continuously reinforced concrete pavements (CRCPs) (see [Common Concrete Pavement Types in Chapter 3](#)). However, some agencies reinforce odd-shaped panels to hold expected cracks tight (ACPA 2008) and use jointless, continuously reinforced concrete for high-traffic urban routes.

Conventional reinforcement is generally in the form of welded-wire fabric or deformed bars that are placed at specific locations in the pavement. As an alternative, reinforcing fibers are added to the fresh concrete during the batching and mixing process, and they are equally distributed throughout the concrete. Fibers are available in a variety of chemistries, lengths, and shapes, and they can be used at various dosages to reach desired performance levels within the pavement or overlay.

Materials for Dowel Bars, Tiebars, and Reinforcement

These items are often collectively referred to as “steel” but may be made of other materials.

Steel

Steel is the most common material for dowels, tiebars, and reinforcement. Dowels and tiebars should conform to ASTM A615/A615M and AASHTO M 31M/M 31-17. Their typical yield strength is 60 kip; 40 kip is allowable. Tiebars can be Grade 420 (60) or 280 (40); yield strength determines required length.

Steel fibers are generally 0.5 to 2.5 in. long and 0.017 to 0.04 in. in diameter. The usual amount of steel fibers ranges from 0.25 to 2 percent by volume, or 33 to 265 lb/yd³. Steel fibers are generally used at high rates for improved hardened properties. The benefits of steel fibers include up to 150 percent increase in flexural strength, reduced potential for cracking during concrete shrinkage, and increased fatigue strength (Kosmatka and Wilson 2016).

Epoxy-Coated Bars

Corrosion resistance is key for embedded steel, particularly in harsh climates where deicing chemicals are used on pavements. The most common method of resisting or delaying corrosion is coating steel bars with epoxy at 0.008 to 0.012 in. thick. Epoxy-coated tiebars should conform to ASTM A775/A775M and AASHTO M 284, and epoxy-coated dowel bars should conform to AASHTO M 254.

Epoxy-coated steel is still susceptible to corrosion, particularly when incorrect handling in the field results in nicks or scratches in the epoxy coating.

Epoxy-coated dowels should be coated with a bond-breaking material to prevent them from locking up the joint. This material is typically applied by the manufacturer. If the dowels are left exposed to the elements for an extended time (e.g., at a project site or over the winter), the bond breaker must be reapplied on at least one end of each bar. Materials applied in the field are typically form-release oil or white-pigmented curing compound. Do not use grease because it will form a void space around the bar, preventing the concrete from consolidating adequately and fully encasing the dowel.

Stainless Steel Bars

Some agencies have experimented with stainless steel (304 and 316) reinforcing bars for long-life concrete pavements. Solid stainless steel is very expensive, but it has a much longer service life. Stainless steel dowels should conform to ASTM A955/A955M.

Stainless-Clad Bars

Stainless-clad steel dowel bars have a 0.070 to 0.090 in. thick stainless steel cladding that is metallurgically bonded to a carbon steel core. They are quite expensive compared to epoxy-coated bars, but they cost less than solid stainless steel while offering its long service life.

Fiber-Reinforced Polymer

Fiber-reinforced polymer (FRP) dowels consist of a binder, a reinforcing element, and inert materials. The binders can be either resin or polymer materials, such as polyester, vinyl ester, or epoxy. The reinforcing material can be fiberglass, carbon fiber, graphite fiber, or other materials. The inert filler material can be calcium carbonate, clay, or hydrated alumina. FRP is a generic term referring to the use of any of the reinforcing materials described above, while glass fiber-reinforced polymer (GFRP) is a specific term that refers to only glass FRP.

The bars are made through a process called pultrusion in which the reinforcing elements are pulled through a bath of the binder and then through a die, where the resin is cured. Stock is typically produced with a specified diameter in pieces that are several feet in length. This stock is cut or sheared to produce dowel bars with specified lengths.

Several manufacturers produce varieties of solid FRP dowels, and one manufacturer produces a composite dowel comprising a carbon steel dowel that is encapsulated in FRP. Tubular FRP dowels (usually filled with cementitious grout, urethane, or another material) have also been used experimentally (Snyder 2011).

The primary benefit of FRP dowels is that they are noncorroding and offer the potential for consistent long-term load transfer. Other possible benefits include the following:

- They may provide less restraint to joint opening and closing than many other types of dowels, even when modestly misaligned, because they can be fabricated with very smooth surfaces and have a lower material stiffness than metallic dowels.
- Their lighter weight may facilitate field handling and reduce unit shipping costs.
- They may provide less restraint of slab curl, thereby reducing early-age curling stresses.

FRP dowels have a much lower elastic modulus than conventional steel dowels, typically around 5 million lb/in² for FRP versus 29 million lb/in² for steel. Many studies and field measurements have shown that this results in higher differential deflections across FRP-doweled joints if the dowel size is not increased and/or if the dowels are not more closely spaced (Snyder 2011). Another possible concern is the availability of FRP recycling options at the end of pavement life.

The use of FRP dowels in the US has mainly been confined to short demonstration sections, but there have been a few notable major construction projects using FRP dowels, including an 18-mile section of Interstate 84 near Boise, Idaho, that was built in 2010. They are also being used more frequently in areas with vehicle detection systems on cash-free toll roads (where steel dowels might interfere with magnetic loop detectors). They may be used more frequently outside of the US.

Although higher joint deflections and lower load-transfer values have been observed on many FRP dowel installations, no significant performance problems (i.e., increases in slab cracking, joint spalling, or joint faulting, or decreases in ride quality) have been reported (Snyder 2011).

Synthetic Fibers

Synthetic reinforcing fibers are manufactured from various materials such as acrylic, aramid, carbon, nylon, polyethylene, and polypropylene. The most common synthetic fibers used in pavements and overlays are polypropylene and polypropylene copolymers, which are nonabsorptive and not susceptible to alkali attack. Synthetic fibers are used in two forms depending on the reinforcement goals: relatively low dosages of micro synthetic filaments to reduce plastic shrinkage and settlement cracking and higher dosages of macro synthetic filaments to reduce cracking, add flexural toughness, and improve surface durability and fatigue resistance.

Fine micro fibers with diameters less than 0.012 in. are typically used at low addition rates of 0.03 to 0.20 volume percent, equating to fiber quantities of 0.50 to 3.0 lb/yd³. At these levels, the fibers may reduce plastic cracking. Macro fibers with diameters greater than 0.012 in. are typically used in dosages representing 0.20 percent by volume (3 lb/yd³) and higher, depending on the desired performance values. Improvement in flexural toughness is one of the most valuable contributions of such fibers to concrete pavements. Macro fibers, in sufficient dosage, also increase fatigue performance (Mulheron et al. 2015) and at higher concentrations add to crack width control.

Several existing pavement design methods are available for determining the thickness of fiber-reinforced concrete (FRC) pavements, such as Pavementdesigner.org and OptiPave. These design methods depend on the FRC attaining a minimum level of residual strength.

The performance of fibers at sawn joints depends on slab thickness, joint spacing, joint opening width, saw-cut depth, and mixture components. Depending on their effectiveness in holding cracks tight, synthetic macro fibers may offer additional shear load transfer through fiber-enhanced aggregate interlock compared to plain unreinforced concrete. Joint spacing for FRC pavement slabs with quantities of synthetic microfibers less than 5.0 lb/yd³ should follow the same guidelines as those for plain concrete or slabs with minimum conventional reinforcement. Macro fibers have been used to extend joint spacing beyond conventional recommendations when sufficient dosages are used (4.5 to 15.0 lb/yd³) (Holland et al. 2008, Kevern and Rupnow 2015).

Other Materials

Stainless steel tubes and pipe filled with concrete have also been used experimentally, but their long-term performance has not yet been demonstrated. Low-carbon microcomposite steels have been shown to be more corrosion resistant than epoxy-coated steel in some tests and quite cost effective. Zinc-coated dowel bars are also showing promise as longer-term performance is becoming more desirable. These proprietary steels are less resistant to corrosion than stainless steel, but they are also less costly.

Curing Compounds

Key Points

- Curing compounds must be applied thoroughly to concrete surfaces after texturing to reduce moisture loss from the surface.
- The most common curing compounds are liquid membrane-forming materials.
- Use pigmented curing compounds so you can see that coverage is complete and uniform.
- Liquid membrane-forming curing compounds are specified by ASTM C309 and ASTM C1315.

Curing compound is applied to the surface and exposed edges of concrete soon after the concrete has been placed and textured. Some people consider the proper time for applying curing compound to be approximately at initial set, when bleeding is complete (Poole 2005). The purpose is to seal the surface—that is, to slow water evaporation from the surface to a rate less than the movement of water up through the concrete—so that hydration can continue for preferably seven or more days (Figure 4-23).

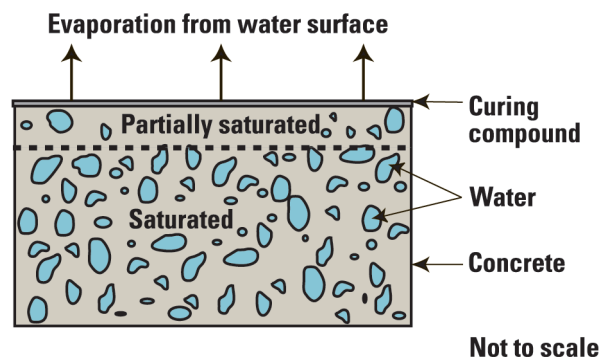

PCA, used with permission

Figure 4-23. Curing compounds keep concrete partially saturated near the surface during the curing period

Cement hydration is a slow chemical reaction (see all of Chapter 5). If water at the concrete surface is allowed to evaporate too quickly, the rate of water loss within the concrete accelerates, the hydration reaction stops, and desirable properties of the concrete, such as durability, will be compromised. It is especially important not to let this happen at the surface of the concrete, which carries the traffic and is exposed to aggressive environments. Proper curing will improve overall concrete durability throughout the slab, reduce surface permeability specifically, and increase surface resistance to wear and weather.

Curing compound should be applied to fresh concrete after bleeding has ended and before the surface dries significantly. Because pavement mixtures do not normally bleed, curing compounds can be applied soon after the mixture leaves the paver.

Types of Curing Compounds

Liquid membrane-forming curing compounds are among the most widely used curing materials for concrete pavements. They are commonly wax- or resin-based compounds, emulsified in water or dissolved in a solvent. These compounds are used rather than water curing for their convenience and economy. After they are applied to the concrete surface, the water or solvent evaporates and the wax or resin forms a membrane on the concrete surface. Liquid membrane-forming compounds need to conform to the requirements of

ASTM C309, AASHTO M 148, and ASTM C1315, as applicable. ASTM C156 and AASHTO T 155 specify a method for determining the efficiency of curing compounds, waterproof paper, and plastic sheeting. Work by Vandenbossche (1999) has demonstrated that products based on poly-alpha-methylstyrene are more effective than other chemicals.

Pigmented curing compounds are recommended because they make it easy to verify proper application. When placing concrete on sunny days and in hot weather, the curing compound should contain a white pigment to reflect the sun's heat. Translucent compounds may contain a fugitive dye that makes it easier to check visually for complete coverage of the concrete surface when the compound is applied. The dye fades soon after application (Taylor 2013).

Not to be confused with curing compounds, evaporation-retarding materials are applied immediately after concrete is placed and before it is finished and cured. Evaporation retarders form a thin, continuous film that retards loss of bleed water, reducing the risk of plastic shrinkage cracking before finishing/curing, particularly in hot, dry weather. If used, evaporation-retarding materials should be applied as soon as possible after placement. They should not be used as a finishing aid but can be worked into the surface during finishing without damaging the concrete.

References

AASHTO M 6 *Standard Specification for Fine Aggregate for Hydraulic Cement Concrete.*

AASHTO M 31M/M 31-17 *Standard Specification for Deformed and Plain Carbon Steel Bars for Concrete Reinforcement.*

AASHTO M 80 *Standard Specification for Coarse Aggregate for Portland Cement Concrete.*

AASHTO M 85 *Standard Specification for Portland Cement.*

AASHTO M 148 *Standard Specification for Liquid Membrane-Forming Compounds for Curing Concrete.*

AASHTO T 152 *Standard Method of Test for Air Content of Freshly Mixed Concrete by the Pressure Method.*

AASHTO M 154 *Standard Specification for Air-Entraining Admixtures for Concrete.*

AASHTO M 157 *Standard Specification for Ready-Mixed Concrete.*

AASHTO M 194 *Standard Specification for Chemical Admixtures for Concrete.*

AASHTO M 240 *Standard Specification for Blended Hydraulic Cement.*

AASHTO M 254 *Standard Specification for Corrosion Resistant Coated Dowel Bars.*

AASHTO M 284 *Standard Specification for Epoxy-Coated Reinforcing Bars: Materials and Coating Requirements.*

AASHTO M 295 *Standard Specification for Coal Fly Ash and Raw or Calcined Natural Pozzolan for Use as a Mineral Admixture in Concrete.*

AASHTO M 302 *Standard Specification for Ground Granulated Blast Furnace Slag for Use in Concrete and Mortars.*

AASHTO M 307 *Standard Specification for Silica Fume Used in Cementitious Mixtures.*

AASHTO M 321 *Standard Specification for High-Reactivity Pozzolans for Use in Hydraulic-Cement Concrete, Mortar, and Grout.*

AASHTO T 22 *Standard Method of Test for Compressive Strength of Cylindrical Concrete Specimens.*

AASHTO T 26 *Standard Method of Test for Quality of Water to Be Used in Concrete.*

AASHTO T 27 *Standard Method of Test for Sieve Analysis of Fine and Coarse Aggregates.*

AASHTO T 106 *Standard Method of Test for Compressive Strength of Hydraulic Cement Mortar (Using 50-mm or 2-in. Cube Specimens).*

AASHTO T 131 *Standard Method of Test for Time of Setting of Hydraulic Cement by Vicat Needle.*

AASHTO T 152 *Standard Method of Test for Air Content of Freshly Mixed Concrete by the Pressure Method.*

AASHTO T 155 *Standard Method of Test for Water Retention by Liquid Membrane-Forming Curing Compounds for Concrete.*

AASHTO T 157 *Standard Method of Test for Air-Entraining Admixtures for Concrete.*

AASHTO T 197 *Standard Method of Test for Time of Setting of Concrete Mixtures by Penetration Resistance.*

AASHTO T 303 *Standard Method of Test for Accelerated Detection of Potentially Deleterious Expansion of Mortar Bars Due to Alkali-Silica Reaction.*

AASHTO T 336 *Standard Method of Test for Coefficient of Thermal Expansion of Hydraulic Cement Concrete.*

AASHTO TP 118 *Standard Method of Test for Characterization of the Air-Void System of Freshly Mixed Concrete by the Sequential Pressure Method.*

ASTM A615/A615M-04b *Standard Specification for Deformed and Plain Billet-Steel Bars for Concrete Reinforcement.*

ASTM A775/A775M *Specification for Epoxy-Coated Steel Reinforcing Bars.*

ASTM A955/A955M *Specification for Deformed and Plain Stainless Steel Bars for Concrete Reinforcement.*

ASTM C33/C33M *Standard Specification for Concrete Aggregates.*

ASTM C39/C39M *Standard Method of Test for Compressive Strength of Cylindrical Concrete Specimens.*

ASTM C109/C109M *Standard Method of Test for Compressive Strength of Hydraulic Cement Mortar (Using 50-mm or 2-in. Cube Specimens).*

ASTM C125 *Standard Terminology Relating to Concrete and Concrete Aggregates.*

ASTM C131/C131M Standard Method of Test for Resistance to Degradation of Small-Size Coarse Aggregate by Abrasion and Impact in the Los Angeles Machine.

ASTM C136/C136M Standard Test Method for Sieve Analysis of Fine and Coarse Aggregates.

ASTM C150/C150 Standard Specification for Portland Cement.

ASTM C156 Standard Test Method for Water Retention by Concrete Curing Materials.

ASTM C191 Standard Test Method for Time of Setting of Hydraulic Cement by Vicat Needle.

ASTM C204 Standard Test Method for Fineness of Hydraulic Cement by Air-Permeability Apparatus.

ASTM C231/231M Standard Test Method for Air Content of Freshly Mixed Concrete by the Pressure Method.

ASTM C233/C233M Standard Method of Test for Air-Entraining Admixtures for Concrete.

ASTM C260/C260M Standard Specification for Air-Entraining Admixtures for Concrete.

ASTM C294 Standard Descriptive Nomenclature for Constituents of Concrete Aggregates.

ASTM C295/C295M Standard Guide for Petrographic Examination of Aggregates for Concrete.

ASTM C309 Standard Specification for Liquid Membrane-Forming Compounds for Curing Concrete.

ASTM C403/C403M Standard Test Method for Time of Setting of Concrete Mixtures by Penetration Resistance.

ASTM C457/C457M Standard Test Method for Microscopical Determination of Parameters of the Air-Void System in Hardened Concrete.

ASTM C494/C494M Standard Specification for Chemical Admixtures for Concrete.

ASTM C535 Standard Method of Test for Resistance to Degradation of Large-Size Coarse Aggregate by Abrasion and Impact in the Los Angeles Machine.

ASTM C595/C595M Standard Specification for Blended Hydraulic Cements.

ASTM C618 Standard Specification for Coal Fly Ash and Raw or Calcined Natural Pozzolan for Use in Concrete.

ASTM C666/C666M Standard Test Method Resistance of Concrete to Rapid Freezing and Thawing.

ASTM C672/C672M Standard Test Method for Scaling Resistance of Concrete Surfaces Exposed to Deicing Chemicals.

ASTM C989/C989M Standard Specification for Slag Cement for Use in Concrete and Mortars.

ASTM C1017 Standard Specification for Chemical Admixtures for Use in Producing Flowing Concrete.

ASTM C1138 Standard Test Method for Abrasion Resistance of Concrete (Underwater Method).

ASTM C1157/C1157M Standard Performance Specification for Hydraulic Cement.

ASTM C1240 Standard Specification for Silica Fume Used in Cementitious Mixtures.

ASTM C1260 Standard Test Method for Potential Alkali Reactivity of Aggregates (Mortar-Bar Method).

ASTM C1293 Standard Test Method for Determination of Length Change of Concrete Due to Alkali-Silica Reaction.

ASTM C1315 Standard Specification for Liquid Membrane-Forming Compounds Having Special Properties for Curing and Sealing Concrete.

ASTM C1567 Standard Test Method for Determining the Potential Alkali-Silica Reactivity of Combinations of Cementitious Materials and Aggregate (Accelerated Mortar-Bar Method).

ASTM C1600/C1600M Standard Specification for Rapid Hardening Hydraulic Cement.

ASTM C1602/C1602M Standard Specification for Mixing Water Used in the Production of Hydraulic Cement Concrete.

ASTM C1603 Standard Test Method for Measurement of Solids in Water.

ASTM C1709 Standard Guide for Evaluation of Alternative Supplementary Cementitious Materials (ASCM) for Use in Concrete.

ASTM D3963/D3963M Standard Specification for Fabrication and Jobsite Handling of Epoxy-Coated Steel Reinforcing Bars.

- Abrams, D. A. 1924. *Design of Concrete Mixtures*. Bulletin 1. Sixth Printing. Structural Materials Research Laboratory, Lewis Institute, Chicago, IL.
- Abrams, D. and S. Walker. 1921. *Quantities of Materials for Concrete*. Bulletin 9. Structural Materials Research Laboratory, Lewis Institute, Chicago, IL. http://www.cement.org/pdf_files/l009.pdf.
- Addis, B. and G. Owens. 1994. *Commentary on SABS 1983:1994 Aggregates from Natural Sources, Aggregates for Concrete*. Cement and Concrete Institute, Midrand, South Africa.
- American Coal Ash Association. 2003. *Fly Ash Facts for Highway Engineers*. Fourth Edition. FWH-IF-03-019. Federal Highway Administration, Washington, DC. https://www.fhwa.dot.gov/pavement/pub_details.cfm?id=48.
- ACI. 2003. *Use of Fly Ash in Concrete*. 232.2R. American Concrete Institute, Farmington Hills, MI.
- . 2011. *Slag Cement in Concrete and Mortar*. 233R-03. American Concrete Institute, Farmington Hills, MI.
- . 2012. *Report on the Use of Raw or Processed Natural Pozzolans in Concrete*. 232.1R. American Concrete Institute, Farmington Hills, MI.
- . 2013. *Guide for Design of Jointed Concrete Pavements for Streets and Local Roads*. 325.12R-02. American Concrete Institute, Farmington Hills, MI.
- . 2014. *Building Code Requirements for Structural Concrete and Commentary*. 318R. American Concrete Institute, Farmington Hills, MI. http://uoqasim.edu.iq/e_Learning/lec_file/ACI%20318R-14.pdf.
- ACPA. 1991. *Design and Construction of Joints for Concrete Highways*. Concrete Paving Technology TB010.01P. American Concrete Pavement Association, Skokie, IL.
- . 2008. *Airfield Joints, Jointing Arrangements and Steel*. Concrete Paving Technology TB017P. American Concrete Pavement Association, Skokie, IL.
- ARA, Inc., ERES Consultants Division. 2004. *Guide for Mechanistic-Empirical Design of New and Rehabilitated Pavement Structures*. National Cooperative Highway Research Program, Washington, DC. <http://onlinepubs.trb.org/onlinepubs/archive/mepdg/guide.htm>.
- Barger, G. S., M. R. Lukkarila, D. L. Martin, S. B. Lane, E. R. Hansen, M. W. Ross, and J. L. Thompson. 1997. Evaluation of a Blended Cement and a Mineral Admixture Containing Calcined Clay Natural Pozzolan for High-Performance Concrete. *Proceedings of the Sixth International Purdue Conference on Concrete Pavement Design and Materials for High Performance*, November 18–21, Indianapolis, IN. pp. 131–147.
- Barksdale, R. D. 1991. *The Aggregate Handbook*. National Stone Association, Washington, DC.
- Bektas, F., P. C. Taylor, and K. Wang. 2010. Scaling Resistance of Concrete Containing Slag Cement: A Critical Review. Paper presented at Transportation Research Board 89th Annual Meeting, January 10–14, Washington, DC.
- Bhatti, M. S. Y. 1985. Mechanism of Pozzolanic Reactions and Control of Alkali-Aggregate Expansion. *Cement, Concrete, and Aggregates*, Vol. 7, No. 2, pp. 69–77.
- Bhatti, M. S. Y. and N. R. Greening. 1978. Interaction of Alkalis with Hydrating and Hydrated Calcium Silicates. *Proceedings of the Fourth International Conference on the Effects of Alkalis in Cement and Concrete*. Purdue University, West Lafayette, IN. pp. 87–111.
- Cross, W., E. Duke, J. Kellar, and D. Johnston. 2000. *Investigation of Low Compressive Strengths of Concrete Paving, Precast and Structural Concrete*. South Dakota Department of Transportation, Pierre, SD.
- Detwiler, R. J., J. I. Bhatti, and S. Bhattacharja. 1996. *Supplementary Cementing Materials for Use in Blended Cements*. Portland Cement Association, Skokie, IL.
- Folliard, K. J., M. D. A. Thomas, and K. E. Kurtis. 2003. *Guidelines for the Use of Lithium to Mitigate or Prevent Alkali-Silica Reaction (ASR)*. FHWA-RD-03-047. Federal Highway Administration, Turner-Fairbank Highway Research Center, McLean, VA. <https://www.fhwa.dot.gov/publications/research/infrastructure/pavements/pccp/03047/>.
- Hall, K. and S. Tayabji. 2011 (revised). *Coefficient of Thermal Expansion in Concrete Pavement Design*. Tech Brief. FHWA-HIF-09-015. Federal Highway Administration, Washington, DC. <https://www.fhwa.dot.gov/pavement/concrete/pubs/hif09015/hif09015.pdf>.

- Holland, J., R. Simonelli, and W. Walker. 2008. Macro Polymeric Fibers for Slabs on Ground. *Concrete Construction*. https://www.concreteconstruction.net/how-to/construction/macro-polymeric-fibers-for-slabs-on-ground_o.
- Johansen, V. C., P. C. Taylor, and P. D. Tennis. 2006. *Effect of Cement Characteristics on Concrete Properties*. Second Edition. Portland Cement Association, Skokie, IL.
- Kandhal, P. S. and F. Parker, Jr. 1998. *NCHRP Report 405: Aggregate Tests Related to Asphalt Concrete Performance in Pavements*. National Cooperative Highway Research Program, Washington, DC.
- Kevern, J., T. Rupnow, M. Mulheron, Z. Collier, and P. Icenogle. 2016. *Evaluation of the Fatigue and Toughness of Fiber Reinforced Concrete for Use as a New Highway Pavement Design*. Louisiana Transportation Research Center, Baton Rouge, LA.
- Kosmatka, S. H. and J. A. Farny 1997. *Diagnosis and Control of Alkali-Aggregate Reactions in Concrete*. Portland Cement Association, Skokie, IL.
- Kosmatka, S. H. and M. L. Wilson. 2016. *Design and Control of Concrete Mixtures*. 16th Edition. Portland Cement Association, Skokie, IL.
- Lobo, C. and G. M. Mullings. 2003. Recycled Water in Ready Mixed Concrete Operations. *Concrete In Focus*. <https://www.nrmca.org/research/33%20CIF%2003-1%20wash%20water.pdf>.
- Liu, T. C. and J. E. McDonald. 1981. Abrasion-Erosion Resistance of Fiber-Reinforced Concrete. *Cement, Concrete, and Aggregates*, Vol. 3, No. 2, pp. 93–100.
- McCaig, M. 2002. Demonstration Eases Sand Concerns. *Aggregates Manager*. September 2002.
- Mindess, S., J. F. Young, and D. Darwin. 2003. *Concrete*. Second Edition. Prentice Hall, Upper Saddle River, NJ.
- Mulheron, M., J. T. Kevern, and T. D. Rupnow. 2015. Laboratory Fatigue and Toughness Evaluation of Fiber-Reinforced Concrete. *Transportation Research Record: Journal of the Transportation Research Board*, No. 2508, pp. 39–47.
- Owens, G. and F. S. Fulton. 2009. *Fulton's Concrete Technology*. Ninth Edition. Cement and Concrete Institute, Midrand, South Africa.
- Ozol, M. A. 2006. Alkali-Carbonate Rock Reaction. *In Significance of Tests and Properties of Concrete and Concrete Making Materials*. ASTM International, West Conshohocken, PA. pp. 341–364.
- Poole, T. S. 2005. *Guide for Curing of Portland Cement Concrete Pavements*. Volume I. FHWA-RD-02-099. Federal Highway Administration, Turner-Fairbank Highway Research Center, McLean, VA.
- Porter, M. L. and R. J. Guinn. 2002. *Assessment of Dowel Bar Research*. Center for Transportation Research and Education, Ames, IA.
- PCA. 2000. *Survey of Mineral Admixtures and Blended Cements in Ready Mixed Concrete*. Portland Cement Association, Skokie, IL.

- Quiroga, P. and D. Fowler. 2004. Chemical Admixtures and Supplementary Cementing Materials in Concrete with High Microfines. In *Proceedings of Aggregates: Asphalt Concrete, Portland Cement Concrete Bases, and Fines*, Twelfth Annual Symposium, April 4–7, Denver, CO.
- Ramachandran, V. S. 1995. *Concrete Admixtures Handbook: Properties Science, and Technology*. Noyes Publications, Park Ridge, NJ.
- Schlörholtz, S. and R. D. Hooton. 2008. *Deicer Scaling Resistance of Concrete Pavements, Bridge Decks, and Other Structures Containing Slag Cement, Phase 1: Site Selection and Analysis of Field Cores*. Federal Highway Administration, Washington, DC.
- Smith, K. D., D. G. Peshkin, M. I. Darter, A. L. Mueller, and S. H. Carpenter. 1990. *Performance of Jointed Pavements*, Vol. IV: Appendix A - Project Summary Reports and Summary Tables. FHWA-RD-89-139. Federal Highway Administration, Turner-Fairbank Highway Research Center, McLean, VA.
- Snyder, M. B. 2011. *Guide to Dowel Load Transfer Systems for Jointed Concrete Roadway Pavements*. National Concrete Pavement Technology Center, Ames, IA.
- Snyder, M. B., T. L. Cavalline, G. Fick, P. Taylor, S. Klokke, and J. Gross. 2018. *Recycling Concrete Pavement Materials: A Practitioner's Reference Guide*. National Concrete Pavement Technology Center, Iowa State University, Ames, IA.
- Stark, D. 1989. *Durability of Concrete in Sulfate-Rich Soils*. Portland Cement Association, Skokie, IL. <http://citeseerx.ist.psu.edu/viewdoc/download?doi=10.1.1.464.9240&rep=rep1&type=pdf>.
- Taylor, P. C. 2013. *Concrete Curing*. CRC Press, Boca Raton, FL.
- Thomas, M. D. A. and M. L. Wilson. 2002. *Admixtures for Use in Concrete*. CD-ROM CD039. Portland Cement Association, Skokie, IL.
- Thomas, M. D. A., B. Fournier, and K. J. Folliard. 2013. *Alkali-Aggregate Reactivity (AAR) Facts Book*. FHWA-HIF-13-019. Federal Highway Administration, Washington, DC. <https://www.fhwa.dot.gov/pavement/concrete/asr/pubs/hif13019.pdf>.
- Vandenbossche, J. M. 1999. *A Review of the Curing Compounds and Application Techniques Used by the Minnesota Department of Transportation for Concrete Pavements*. Minnesota Department of Transportation, St. Paul, MN.
- Whiting, D. and W. Dziejczak. 1992. *Effects of Conventional and High-Range Water Reducers on Concrete Properties*. Portland Cement Association, Skokie, IL.
- Whiting, D. and M. A. Nagi. 1998. *Manual on the Control of Air Content in Concrete*. Portland Cement Association, Skokie, IL.
- Wigum, B. J., P. Holmgeirsdottir, S. W. Danielsen, and O. V. Anderson. 2004. *Production and Utilisation of Manufactured Sand for Concrete Purposes*. Journal No. 128-03. Hönnun, Reykjavik, Iceland.

1	Intro
2	Sustainability
3	Design
4	Materials
5	Hydration
6	Properties
7	Mixtures
8	Construction
9	QA/QC
10	Troubleshooting

Chapter 5

Hydration/Transformation of Concrete from Plastic to Solid

Introduction	96
Stages of Hydration: Overview	96
Portland Cement	101
Reactions of Supplementary Cementitious Materials	109
Impact of Hydration	112
Stages of Hydration: Details	122
References	126

Introduction

At the concrete plant, the ingredients discussed in Chapter 4—cementitious materials, water, aggregates, and chemical admixtures—are mixed together. During the next few hours, the mixture changes from a workable, plastic mixture to a rigid, solid material. Central to this transformation is a chemical process called hydration—an irreversible series of chemical reactions between water and cement. Hydration is not well understood by many people involved in designing and constructing concrete pavements. The goal of Chapter 5 is to clarify this process, focusing on the practical implications for designers and construction personnel.

Why should readers care about hydration? The chemical reactions taking place during the first few hours influence how the concrete mixture behaves when it is being placed and finished. Later reactions govern how strong and durable the hardened concrete becomes. With a general understanding of these reactions, readers can help prevent or correct problems and ensure the concrete mixture performs as it was designed.

Notes to help you use Chapter 5:

- Section Stages of Hydration provides a brief graphical overview of cement hydration
- Section Portland Cement discusses what portland cement is made of and how these compounds react with water to form the products that make concrete perform the way it does
- Section Reactions of Supplementary Cementitious Materials (SCMs) discusses the reaction of SCMs
- Section Impact of Hydration describes how the reaction products affect the performance of the fresh and the hardened concrete
- Section Stages of Hydration repeats the graphical overview but in far more detail

There is some repetition of information throughout this chapter, as the text moves from a basic discussion to a more technical and detailed discussion and addresses the information from different perspectives.

The general discussion about hydration is based on a nominal concrete pavement mixture with a low water-to-cement (w/cm) ratio. Many factors, such as actual w/cm ratio, cement fineness, aggregate gradation, consolidation, curing, and environment, strongly influence the performance of a pavement. These factors are discussed in more detail in other chapters, including [Chapters 4, 6, and 8](#).

In practice, the time/heat curve discussed throughout this chapter is obtained from a small (e.g., approximately 0.8 to 4.2 oz), insulated concrete sample using an instrument called a calorimeter. For the discussion in this chapter, only changes in heat associated with cement hydration are considered. The time/heat curves presented do not represent actual time/heat curves of a full-depth concrete slab, which will include heat contributed from external sources like sunlight and slower cooling due to insulation and the thermal mass of a full-depth slab.

This chapter uses cement chemists' shorthand notation to describe compounds: A = Al_2O_3 (aluminum oxide), C = CaO (lime), F = ferric oxide, H = H_2O (water), M = magnesium oxide, S = SiO_2 , \bar{S} = sulfur trioxide), and \bar{C} = CO_2 . Thus, alite is C_3S .

Stages of Hydration: Overview

Portland cement is manufactured by mixing limestone, clay, and shale together at a very high temperature, forming a product called clinker, then intergrinding that resulting clinker with gypsum. This process results in three primary ingredients in cement that react during hydration (Figure 5-1):

- Calcium silicates (from the clinker, referred to as silicates)
 - Alite (C_3S)
 - Belite (C_2S)
- Calcium aluminates (from the clinker, referred to as aluminates)
 - Tricalcium aluminate (C_3A)
 - Ferrite (C_4AF)
- Calcium sulfates (from the gypsum, plaster, or anhydrite, referred to as gypsum)
 - Gypsum (dihydrate)
 - Plaster (hemihydrate)
 - Anhydrite

Silicates, aluminates, and gypsum all contain calcium and oxygen in varying amounts.

Hydration begins as soon as water and cement come into contact. The cement particles slowly, partially dissolve, and the various dissolved components start to react at various rates. During the reactions, heat is generated and new compounds called hydration products are produced. The new compounds form a solid and cause the plastic cement paste to harden, bond to the aggregate in the concrete mixture, and become strong and dense.

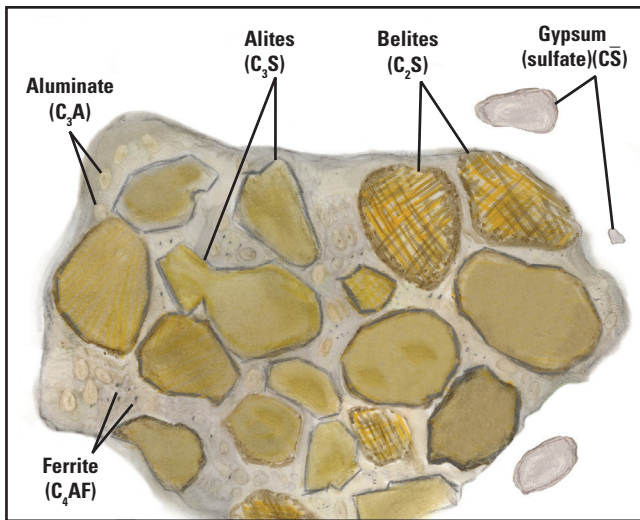

Figure 5-1. Compounds in cement

The reactions with water can be described in five stages—mixing, dormancy, hardening, cooling, and densification. The reactions can also be tracked by monitoring the heat generated at each stage (Figure 5-2)—a brief heat spike during mixing; no heat generated during dormancy; a significant, steady rise in heat during hardening; a peak and then a continuous drop in heat evolution during cooling; and, finally, relatively little heat generated during densification. A chemical reaction that produces heat, like hydration does, is called exothermic.

The basic explanation of the five stages describes how concrete generally reacts when the system is balanced and performing as designed.

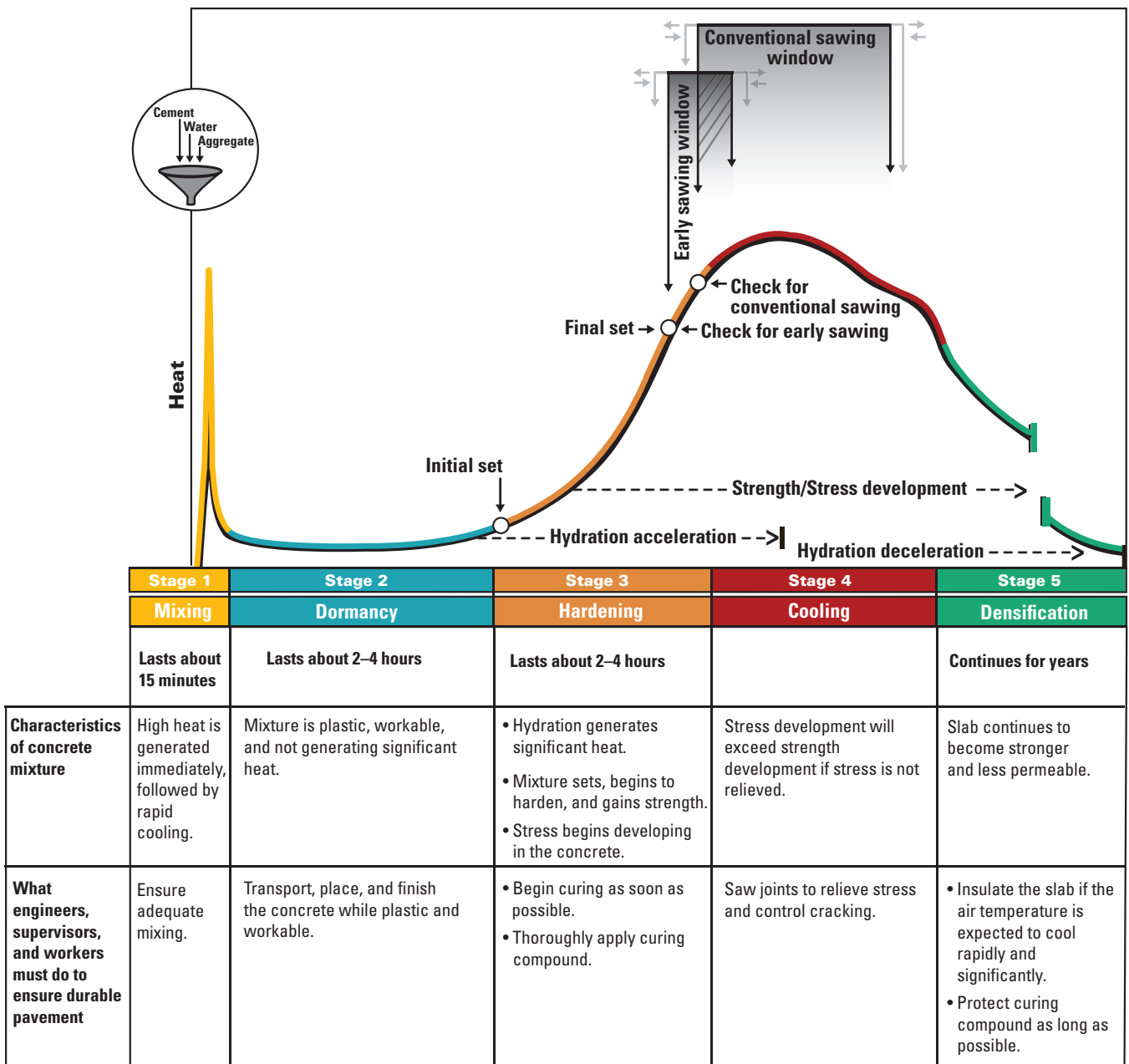

Figure 5-2. Concrete characteristics, and implications for workers, during stages of hydration

Mixing

During hydration, the reactions between silicates and water produce the primary compounds that make concrete strong and durable. However, silicates dissolve very slowly and do not have an immediate effect on strength.

When mixed with water, C_3A and gypsum dissolve instantly. Within minutes of being mixed with

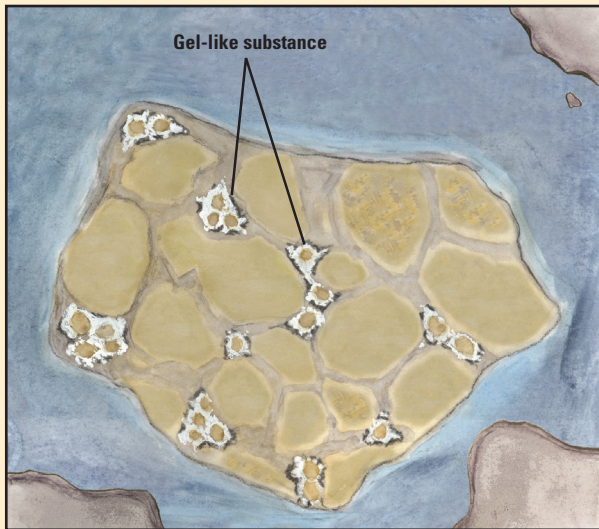

Figure 5-3. A gel-like substance coats cement compounds, controlling the reactions and heat

water, solid compounds form from these materials, generating significant heat and beginning the process of hardening, or setting. Unchecked, these reactions would cause irreversible, flash set or stiffening of the concrete.

To control C_3A reactions, the addition of gypsum is critical. The fast-dissolving gypsum reacts with the dissolved C_3A and water to create a substance that coats the cement grains (Figure 5-3). This coating, and hydration products in general, is often referred to as a “gel,” which is a solid without a specific composition or crystalline form. The gel coating slows the aluminate reactions almost as soon as they start, reducing the amount of heat generated and the potential for flash set (Figure 5-4).

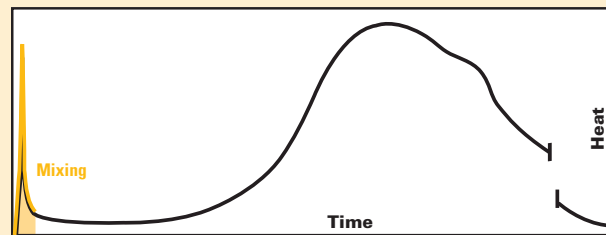

Figure 5-4. A very brief heat spike occurs during mixing

Dormancy

Aluminate reactions are generally controlled for about two to four hours, the dormant period. During this time, the concrete is plastic and does not generate heat (Figure 5-5). The dormant stage gives the construction crew time to transport, place, and finish the concrete while it is workable.

During dormancy, it looks as though nothing is happening in the mixture. However, the cement is

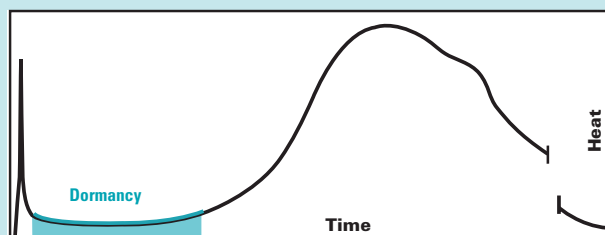

Figure 5-5. The concrete does not generate heat during the dormancy stage

continuing to dissolve, and the water is becoming saturated with dissolved calcium and hydroxyl (OH) ions (Figure 5-6). When the water has an overabundance of calcium ions, known as supersaturation, the hardening process begins.

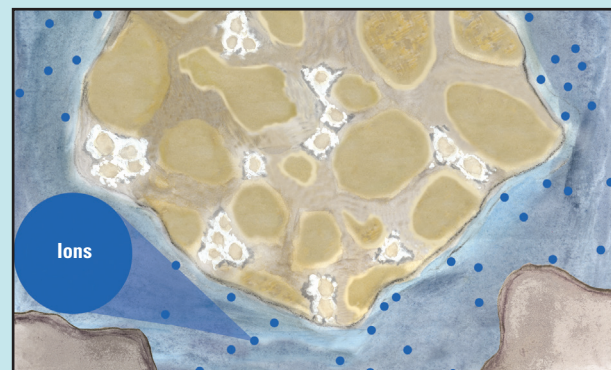

Figure 5-6. During dormancy, the water becomes saturated with dissolved ions

Hardening

When the water becomes supersaturated with dissolved calcium ions, hydration products begin forming, heat is generated, and the mixture begins stiffening. This is the beginning of the hardening stage (Figure 5-7).

Initial set occurs soon after the mixture begins stiffening. After initial set, construction workers should not work, vibrate, or finish the concrete. Any segregation of materials during this stage will be permanent. Workers should apply curing compound as soon as possible after finishing to control water evaporation from the concrete surface. If the water is lost, the hydration reaction will not reach completion, reducing the strength and durability of the final concrete product. Likewise, if the heat from the hydration reactions is lost, the hydration reaction will be slowed or will cease. This requirement of maintaining water and heat within the concrete (i.e., curing) is absolutely critical to achieving high-quality concrete.

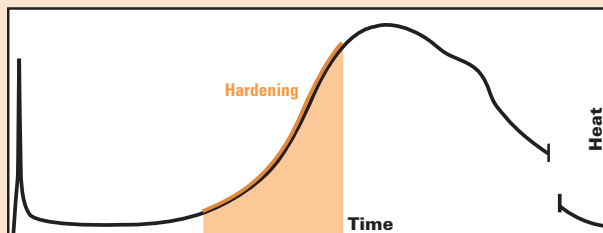

Figure 5-7. Significant heat is generated during the hardening stage

During the hardening stage, hydration products continue growing and heat continues to be generated. Hydration products initiate on an existing solid material, or they form spontaneously by the ions in solution combining. When they initiate on an existing solid material, the point of initiation is called a nucleation site. These nucleation sites could be a cement grain, an SCM particle, or a limestone grain in the case of a portland limestone cement (PLC). Some of the hydration products are finger-like, fibrous growths; others are more flat or equiaxed (Figure 5-8). These compounds interweave and mesh together around the aggregates, causing the concrete to become stiffer and eventually solidify. At final set, the concrete has become strong enough to walk on. Still, the concrete cannot carry traffic.

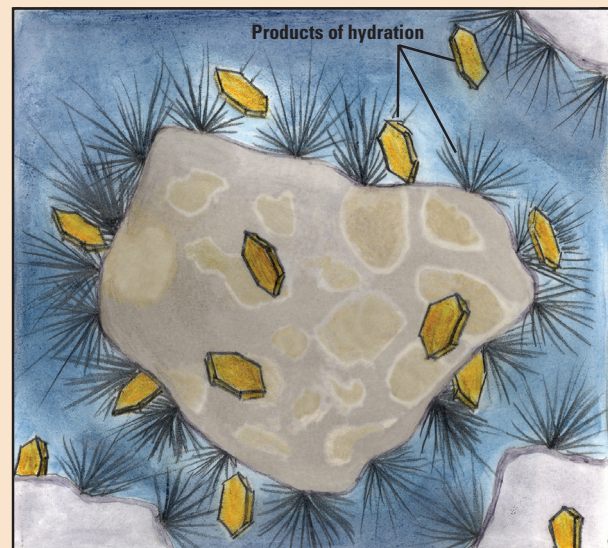

Figure 5-8. Hydration products grow

Cooling

Due to changes in temperature and moisture content, the concrete shrinks. Friction between the shrinking concrete and the base layer under the pavement causes stress that eventually causes the concrete to separate or crack. To relieve the stress and prevent concrete from cracking randomly, workers must saw joints. Joints simply control the crack locations.

There is a brief period of time, perhaps only two to four hours, to saw joints successfully. This period is called the sawing window. The sawing window begins when the concrete can be sawed without excessive raveling, and ends before the concrete begins to crack randomly. Sawing early disrupts the concrete while still soft; sawing late leads to random cracking of the slab.

Approximately four to six hours after initial set, hydration slows and the amount of heat generated begins to drop (Figure 5-9).

This slowdown is caused by the build-up of hydration products, which will begin to interfere with contact between the remaining water and cement in the concrete (Figure 5-10).

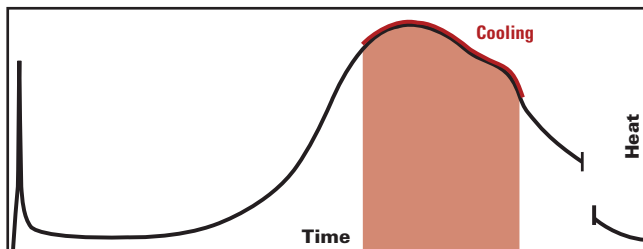

Figure 5-9. Heat energy peaks and then drops during cooling



Figure 5-10. Hydration products grow during cooling

Densification

During the final stage of hydration, the reactions continue slowly, generating relatively little heat (Figure 5-11).

Continued growth and meshing of hydration products results in a strong, solid mass (Figure 5-12). Long after the concrete is strong enough to carry traffic, this process will continue as long as cement and water are present in the concrete, increasing the slab's strength and reducing its permeability.

Construction crews can do two final things to help ensure long-term pavement performance:

- After sawing joints, insulate the pavement if air temperatures are expected to drop rapidly and significantly. If the pavement surface cools too quickly, the slab may crack.
- Keep traffic and construction equipment off the pavement as long as possible, preferably at least 72 hours, to protect the curing compound. Curing compound reduces moisture loss from the concrete and thus enables continued hydration, increasing concrete strength and reducing its permeability.

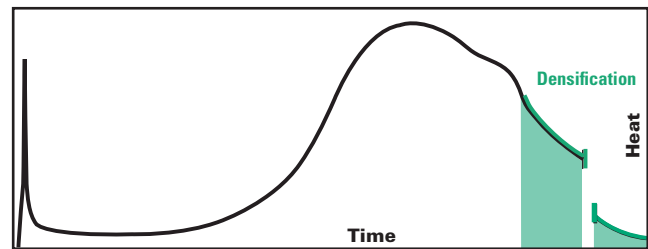

Figure 5-11. Relatively little heat is generated during the final, densification stage

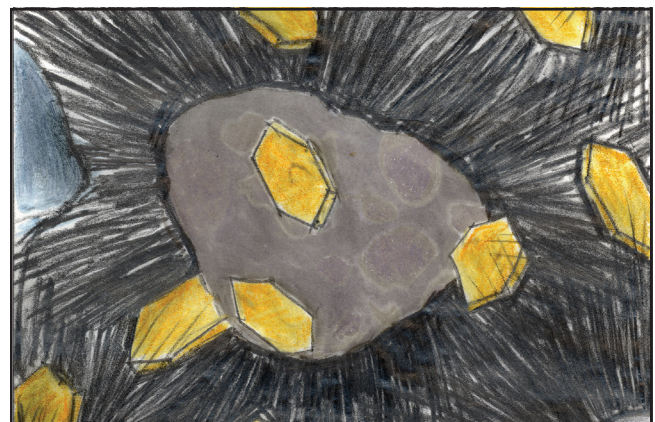

Figure 5-12. Hydration products mesh into a dense solid

Portland Cement

Key Points

- Portland cement primarily consists of clinker ground with gypsum.
- Portland-limestone cement primarily consists of clinker ground with gypsum and limestone.
- Clinker consists of four primary compounds: two silicates and two aluminates.
- Silicates comprise about 75 percent of cement. C₃S contributes to concrete’s initial set and early strength; C₂S contributes to strength gain after approximately one week.
- C₃A hydrates immediately when exposed to water; calcium sulfate (e.g., gypsum) is added to portland cement to control tricalcium aluminate’s hydration rate. The other aluminate, tetracalcium aluminoferrite (C₄AF), contributes little to cement other than its gray color.
- The particle size, or fineness, of portland cement affects hydration rates and concrete properties. Finer cements generally have higher initial hydration rates.

Portland Cement Compounds

The rest of Chapter 5 describes cement chemistry and hydration in more detail, focusing on compounds in cement and concrete. First, the specific compounds in portland cement are described. Then, the role of each of these compounds in hydration is outlined, followed by the results of hydration: new compounds produced, the pore system, various stresses on the system, and the development of concrete strength and low permeability. The effects of using SCMs in the mixture are discussed and, finally, potential incompatibilities that can arise through various combinations of SCMs and admixtures in the mixture are described.

Portland cement is manufactured by heating limestone, clay, and shale in a kiln to above 2,500°F, then grinding the resulting clinker with a source of calcium sulfate, typically gypsum. Portland-limestone cement has inter-ground limestone as well. The final product consists of silicates, aluminates, and sulfates. Other elements and compounds in cement are in smaller proportions, but they can contribute to, or interfere with, the chemical reactions that occur during cement hydration. The primary compounds in portland cement are listed in Table 5-1 and shown in Figure 5-13.

Table 5-1. Major compounds in portland cement

	Name	Phase (compound)	Shorthand notation	Effect	Amount	
Aluminates		Tricalcium aluminate	C ₃ A	<ul style="list-style-type: none"> • Liberates a large amount of heat • Can cause early stiffening and flash set • Prone to sulfate attack 	5%–10%	Clinker
	Ferrite	Tetracalcium aluminoferrite	C ₄ AF	<ul style="list-style-type: none"> • Contributes little to strength • Contributes to gray color 	5%–15%	
Silicates	Alite	Tricalcium silicate	C ₃ S	<ul style="list-style-type: none"> • Hydrates and hardens rapidly • Largely responsible for initial set and early strength 	50%–70%	
	Belite	Dicalcium silicate	C ₂ S	<ul style="list-style-type: none"> • Hydrates and hardens slowly • Contributes to strength increase after one week • Contributes to low concrete permeability 	15%–30%	
Sulfates	Gypsum*	Calcium sulfate	C \bar{S}	<ul style="list-style-type: none"> • Controls the hydration of C₃A 	3%–5%	Gypsum

* See Table 5-2

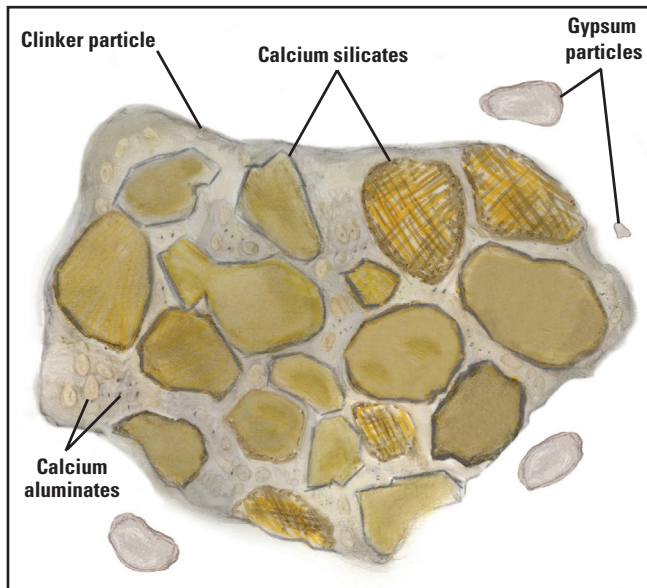

Figure 5-13. Composition of portland cement

Chemical analyses of cementitious materials by x-ray fluorescence spectrometry report the elements as oxides. An example of a mill certificate is shown in Figure 5-14. A mill certificate includes specified limits and test results for various compounds in a specific type of portland cement.

The next sections discuss portland cement’s primary components: clinker and gypsum.

Portland Cement Clinker

Clinker is the major ingredient in portland cement. Clinker is primarily composed of two silicates and two aluminates, the first four compounds listed in [Table 5-1](#).

Silicates

Silica (SiO₂) normally comprises about 20 percent of cement by mass, while calcium oxide (CaO) normally comprises 60 to 65 percent. These combine to form the silicates in clinker: alite (C₃S) and belite (C₂S). Portland cements typically contain approximately 55 percent C₃S and 20 percent C₂S (Johansen et al. 2005).

Table 5-2. Forms of calcium sulfate

	Common names	Shorthand notation	Chemistry	Waters of crystallization	Comments
Calcium sulfate dihydrate	Gypsum	C \bar{S} H ₂	CaSO ₄ •2H ₂ O	2	Rapidly soluble
Calcium sulfate hemihydrate	Plaster or bassanite	C \bar{S} H _½	CaSO ₄ •½H ₂ O	½	Slowly soluble
Anhydrous calcium sulfate	Anhydrite	C \bar{S}	CaSO ₄	None	Not very common

During cement hydration, C₃S contributes to the setting and early strength development of concrete, normally beginning a few hours after mixing. C₂S is the primary compound that contributes to concrete’s later strength development. Its effects become noticeable about a week after mixing.

Aluminates

Alumina is included in the mixture in a cement kiln because it helps reduce the burning temperatures required to make cement. Alumina combines with calcium and iron oxide to form two calcium aluminate compounds in clinker: tricalcium aluminate (C₃A) and tetracalcium aluminoferrite (C₄AF) or ferrite. Typical portland cements contain approximately 10 percent C₃A and 10 percent C₄AF.

During cement hydration, C₃A reacts very rapidly when mixed with water unless controlled by the presence of sulfate (C \bar{S}). Uncontrolled hydration of C₃A can lead to flash set. (See [Aluminate and Sulfate reactions later in this chapter](#).) C₄AF reactions do not contribute significantly to the properties of concrete except for the gray color.

Gypsum

When clinker is being ground to a powder, gypsum is added at about a 5 percent dosage. The primary purpose for including gypsum in portland cement is to provide sulfate, which controls the C₃A reactions during hydration. The C \bar{S} dosage is carefully optimized because the setting characteristics of a cement are influenced by the amount of C \bar{S} ; incompatibility (e.g., uncontrolled stiffening and setting) can occur if the amounts of C \bar{S} and C₃A are out of balance (see [Potential Materials Incompatibilities later in this chapter](#)).

Gypsum is one of three forms of calcium sulfate (C \bar{S}) normally present in portland cement. The three forms are determined by the amount of water tied to the C \bar{S} compounds, as shown in [Table 5-2](#). (See [Form of Sulfate under Sulfate-Related Setting and Stiffening later in this chapter](#).)

Cement Fineness Affects Hydration and Concrete Properties

After clinker leaves the kiln and is cooled, it is pulverized in a grinding mill to reduce its size from a maximum of 1 to 2 in. particles to a powder. The fineness of the cement is controlled by the manufacturer to achieve some performance characteristics. Approximately 95 percent of cement particles are smaller than 45 μm , with the average particle around 15 μm .

With increasing fineness, cement exhibits the following characteristics:

- Increasing rate of hydration initially, leading to increased early strengths
- Longer-term strength development not as pronounced with finer cements
- Increased heat of hydration

- Reduced workability
- Reduced bleeding
- Possible reduced ability to entrain air
- Increased risk of incompatibility

Fineness is usually measured by the Blaine air-permeability test (ASTM C204/AASHTO T 153), which indirectly measures the surface area of cement particles per unit mass (specific surface area). The specific surface area of finer cements is higher than that of coarser cements. Typical Type I cements are in the range of 1,464.7 to 1,953.0 ft^2/lb . Type III cements are generally finer than Type I cements. Intergrinding with limestone to produce PLC typically results in a slightly higher Blaine fineness as compared to portland cement produced without limestone additions.

Portland Cement Hydration

Key Points

- Hydration of portland cement is a series of chemical reactions that release heat.
- C_3A reacts immediately when exposed to water and can cause early stiffening or flash set. This reaction is controlled by adding CS .
- Silicate reactions begin more slowly, but ultimately dominate portland cement hydration, contributing the bulk of concrete properties.
- C_3S contributes to early strength gain.
- C_2S contributes to long-term strength gain and low permeability.
- Calcium silicate hydrate (C-S-H) is the primary product of silicate reactions that contributes to concrete's strength and density.
- Chemical reactions at various stages of hydration have important implications for pavement construction practices, including placement, curing, sawing joints, and opening to traffic.
- Ideally, hydration products will eventually fill most of the space originally occupied by water in the mixture. To produce concrete with low permeability, this requires an appropriate w/cm ratio—enough water to make the mixture workable but not so much that concrete durability is reduced.
- Hydration will continue as long as water and unhydrated cement grains are available. While hydration continues, concrete strength increases and permeability decreases. Curing—primarily, protecting the concrete from heat and moisture loss—is essential for strong, durable concrete.

Hydration is a series of nonreversible chemical reactions between hydraulic cement, such as portland cement, and water. During hydration, the cement-water paste sets and hardens. Hydration begins as soon as portland cement comes in contact with water. The cement

particles slowly, partially dissolve, and the various components start to react at various rates, generating heat and resulting in various reaction products. The reaction products nucleate on cement grains, SCM particles, and ground limestone particles, if present.

The measurable heat generated by hydration does not reach zero for days because the reactions continue over time, slowing as time progresses. The reactions can continue for years, as long as the concrete contains water and unreacted cement, resulting in continued development of strength and other desirable characteristics such as low permeability.

The hydration process has been, and continues to be, the subject of extensive research. However, the primary reactions and hydration products are known and understanding hydration reactions can help everyone involved in concrete pavement projects prevent or correct problems.

The rest of this section on hydration provides general, simplified descriptions of the following:

- Primary chemical reactions of aluminates, sulfates, and silicates

- Products of those reactions
- Development of strength and stresses within concrete during hydration
- Importance of the development of paste density during hydration
- Implications of various stages of hydration on construction practices to ensure strong, durable concrete pavements

Primary Products of Hydration

The primary products of cement hydration and their role in concrete are described in Table 5-3. The chemical reactions in cement hydration result in changing volumes of cement compounds and hydration products (Figure 5-15).

Table 5-3. Primary products of cement hydration

Hydration product	Role in concrete
Calcium silicate hydrate (C-S-H)	<ul style="list-style-type: none"> • C-S-H is a product of silicate reactions—both C_3S and C_2S—with water. • C-S-H is the primary desirable hydration product. It bonds with other C-S-H and with aggregate, and is a major contributor to concrete strength and low permeability. • C-S-H growths gradually spread and mesh with growths from other cement particles or adhere to aggregates. This buildup of solid compounds causes the paste to stiffen, harden, and develop strength and reduces permeability.
Calcium hydroxide (CH)	<ul style="list-style-type: none"> • CH is a crystalline hydration product of silicate reactions—both C_3S and C_2S—with water. • CH <ul style="list-style-type: none"> – May provide a plane of weakness in the concrete (on a microscale). – Is readily soluble in water and may be attacked if the concrete is exposed to soft water or acid. • CH is also beneficial; it helps buffer a high pH necessary for C-S-H to be stable and protects reinforcing steel. • The amount of CH produced when C_2S reacts with water is significantly less than that formed in the C_3S reaction.
Ettringite (C-A-\bar{S}-H)	<ul style="list-style-type: none"> • Ettringite, in the form of needlelike crystals, is the primary product of reactions between C_3A and sulfate ($C\bar{S}$) in solution. These reactions continue until the $C\bar{S}$ is depleted, generally within 24 hours. (See monosulfate, below.) • Ettringite gel is especially important for its role in creating a dormant period early in cement hydration. It does this by limiting access of water to the particles and slowing their hydration. • Ettringite contributes somewhat to concrete’s early strength but plays only a minor role in hardened concrete’s strength.
Monosulfate (C-A-\bar{S}-H)	<ul style="list-style-type: none"> • When all the $C\bar{S}$ has been depleted, the remaining C_3A reacts with the ettringite (C-A-\bar{S}-H) to form monosulfate crystals. • Monosulfate has little effect on concrete’s physical characteristics.
Calcium aluminate hydrate (C-A-H)	<ul style="list-style-type: none"> • Unless $C\bar{S}$ is present in solution, the reaction of C_3A with water will quickly result in undesirable calcium aluminate hydrate. This will cause irreversible setting, or flash set. See the discussion under Potential Materials Incompatibilities later in this chapter.
$C_3A + CH + 12H \rightarrow C_4AH_{13}$	

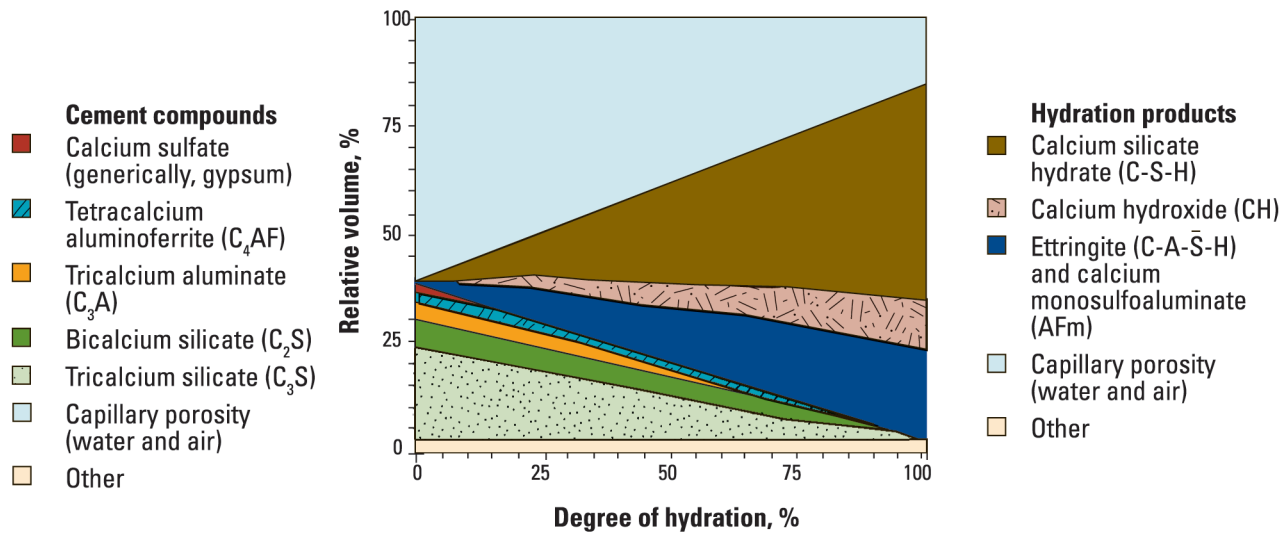

Note: These estimates are for a 0.50 water/cementitious materials ratio; decreasing the ratio will decrease the capillary porosity.

Adapted from Tennis and Jennings 2000

Figure 5-15. Estimates of the relative volumes of cement compounds and products of hydration with increasing hydration

Silicate (Alite and Belite) Reactions

The silicates consist of C₃S and C₂S. C₃S reacts more quickly, giving concrete its early strength. C₂S reacts more slowly, contributing to long-term strength gain and reduction of permeability. The hydration products of silicates and water are C-S-H and calcium hydroxide (CH).

Alite Reactions

C₃S dissolves and reacts with water more slowly than C₃A. During dormancy, C₃S begins dissolving, resulting in calcium ions and OH ions in solution (Figure 5-16). Some calcium ions in solution also result from the dissolution of C₃A, but C₃S is the primary source.

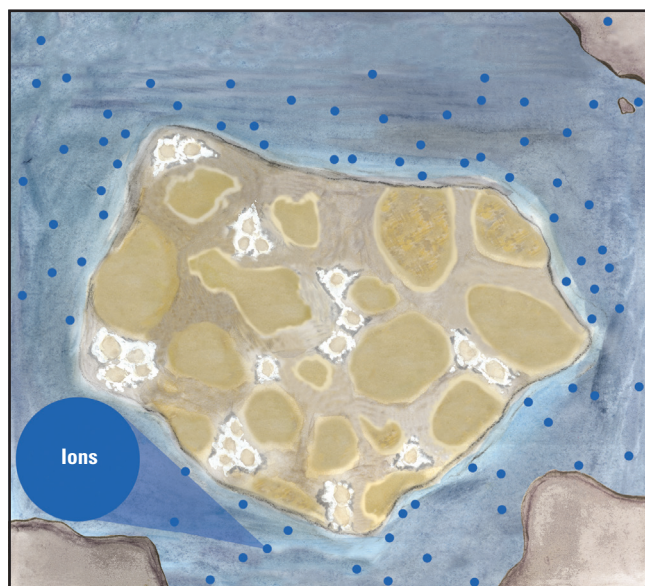

Figure 5-16. Dissolving cement results in calcium ions in solution

The calcium ions accumulate for two to four hours, until the solution becomes supersaturated with calcium ions. When the solution is supersaturated, the calcium ions react with SiO₂ in solution and water to form C-S-H and CH (Figures 5-17 and 5-18).

Soon after commencing production of C-S-H and CH, initial set occurs. A large amount of heat energy is released in these reactions, causing the mixture temperature to begin rising quickly while setting begins. As hydration accelerates, the build-up of C-S-H and CH results in progressive stiffening, hardening, and strength development.

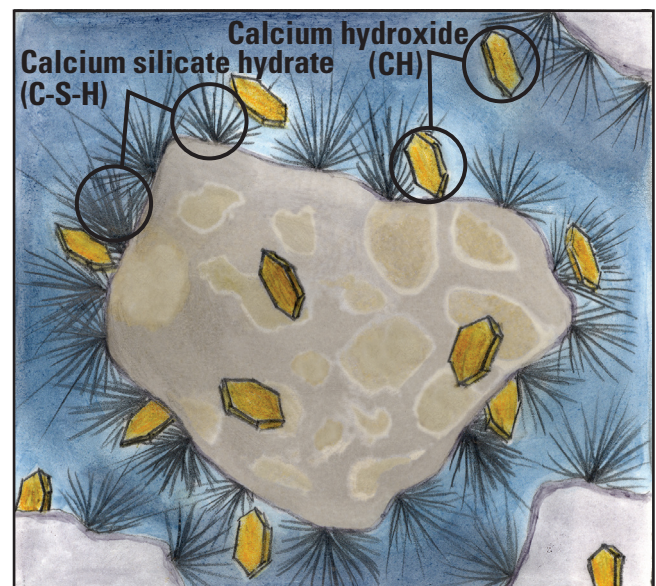

Figure 5-17. C-S-H and CH begin to form

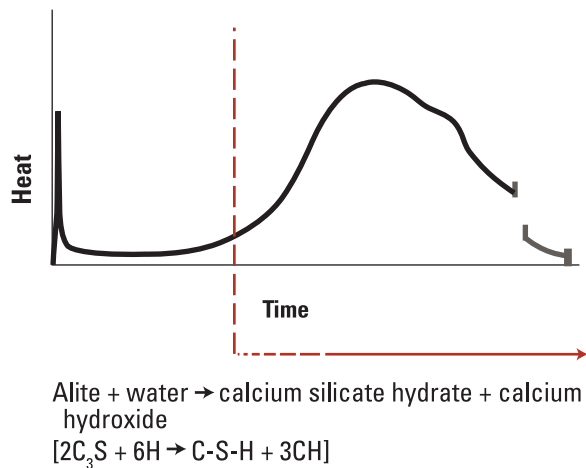

Figure 5-18. C_3S reactions form C-S-H and CH

C-S-H is the desirable product. These particles are in the form of fibrous growths that gradually spread, merge, and adhere to aggregates, giving concrete its strength. With sufficient hydration, C-S-H forms a solid mass.

CH particles tend to be sectile and smooth, and therefore they provide a plane of weakness when the concrete is stressed. Also, CH is readily soluble in water and will dissolve if the concrete is exposed to soft water or acid. This dissolution in water increases at low temperatures, with the solubility being a maximum at the freezing point of water. CH dissolution leads to an increase in concrete permeability, and the dissolved ions contribute to a number of durability-related issues, including alkali-silica reaction (ASR) and chemical deicer attack. However, CH is necessary for maintaining a high concrete pH, which safeguards from corrosion of embedded steel, and for stabilizing the C-S-H.

Initially, the C_3S reactions are relatively fast. After a few hours, however, the hydration products (C-S-H and CH) accumulate to a point at which they interfere with contact between the undissolved cement particles and water, slowing the reactions and thus reducing the heat of hydration (Figure 5-19).

At some time before the rate of heat evolution peaks, final set occurs. Final set is roughly associated with the time when the concrete has become hard enough to walk on or to demold a test cylinder. Final set is measured by ASTM International paste and mortar pressure tests (ASTM C807) at a point when the paste has acquired a certain degree of hardness; however, the values selected are somewhat arbitrary and do not necessarily relate directly to a physical phenomenon in the concrete.

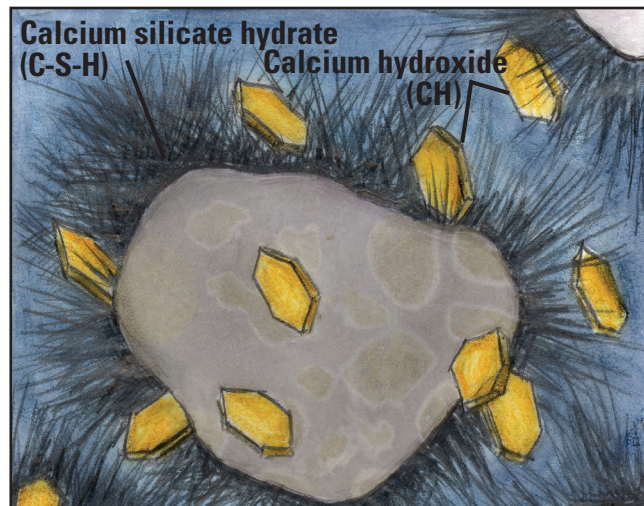

Figure 5-19. Hydration products accumulate and mesh

C_3S reactions will continue as long as unhydrated C_3S grains and water are present and accessible.

Belite Reactions

The other silicate compound, C_2S , mimics the reactions of C_3S , creating the same reaction products but at a slower pace. When mixed with water, C_2S dissolves and releases calcium ions very slowly. Only after several days do C_2S reactions start contributing to strength, but as with C_3S , the reactions continue as long as unhydrated C_2S grains and water are present and accessible (Figure 5-20). Given the slow reaction rate of C_2S , these later strength gains may occur years after placement. Therefore, C_2S reactions are critical to the long-term development of strength and reduction of permeability.

As long as C_3S and C_2S grains remain and there is water in the concrete, the silicates will continue to hydrate.

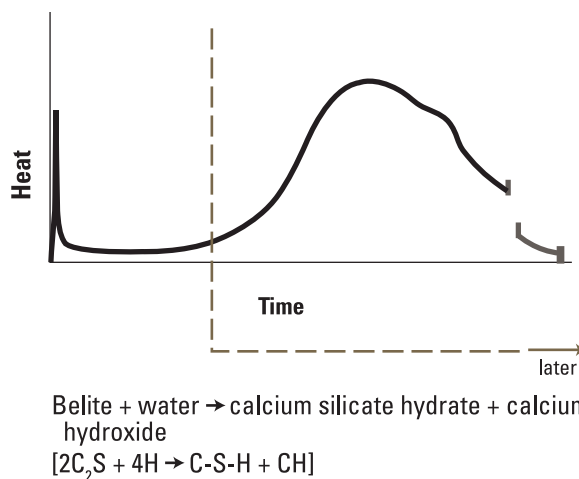

Figure 5-20. C_2S reactions begin contributing to strength gain later

As the volume of hydration products grows, the concrete permeability decreases and the concrete gains strength. Eventually, the hydration products will combine into a solid mass (Figure 5-21).

Aluminate and Sulfate Reactions

The aluminate and $C\bar{S}$ reactions dominate the first 15 minutes of hydration. When mixed in water, C_3A immediately dissolves and reacts with water to form calcium aluminate hydrate (C-A-H) crystals. This reaction generates a large amount of heat and, if uncontrolled by $C\bar{S}$, will cause fast, permanent hardening. This effect—known as flash set—is very undesirable.

$C\bar{S}$, however, controls the C_3A reaction. Combined with $C\bar{S}$ in solution, C_3A forms needle-like ettringite (Figure 5-22).

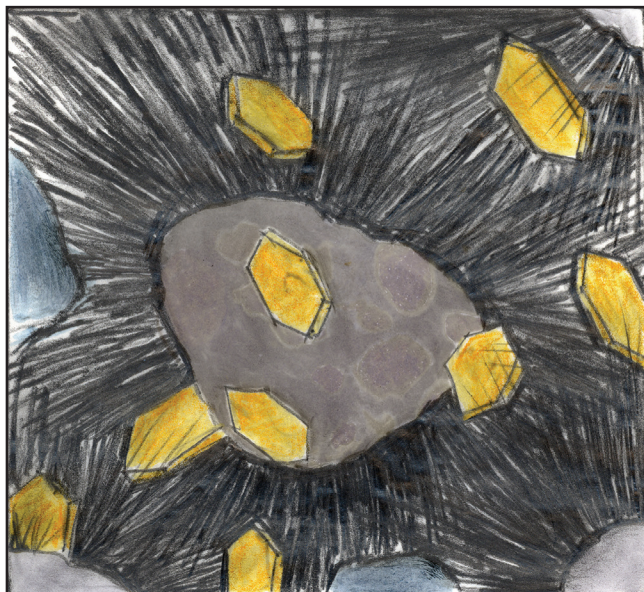

Figure 5-21. C-S-H and CH mesh into a solid mass

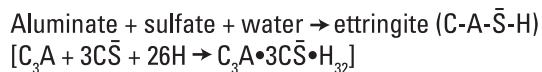
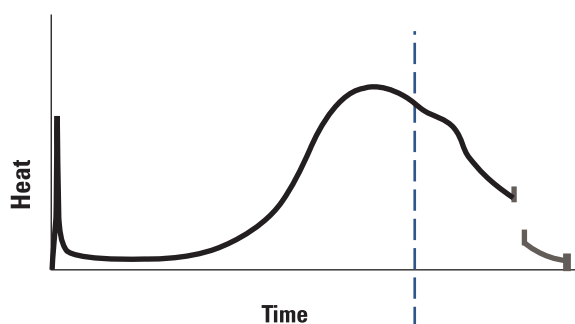

Figure 5-22. Reactions of C_3A and $C\bar{S}$ in solution, are responsible for an early heat spike during cement hydration

Ettringite is a calcium aluminosulfate hydrate (C-A- \bar{S} -H). It is commonly referred to as the Aft phase where the “t” symbolizes “trisulfate,” or three $C\bar{S}$ molecules in the C-A- \bar{S} -H structure.

The initial C-A-H formed combines with the $C\bar{S}$ in solution to form ettringite, which coats the surface of the aluminate grains, limiting water access to the aluminate grains, and thereby slowing further reactions (Figure 5-23).

For the period of time during which reactions are slowed, little heat of hydration is generated and little physical change in the concrete is observed. This is known as the dormant period, which lasts two to four hours. This is important in a concrete paving project because it provides time to transport, place, and finish the concrete mixture while it is plastic.

The importance of the dormant period makes it critical for sufficient sulfate to be included in the cementitious mixture (see Potential Materials Incompatibilities later in this chapter).

After the dormant period, other chemical reactions dominate cement hydration. However, the C_3A and $C\bar{S}$ continue to react and form ettringite, which contributes somewhat to concrete’s early strength development.

The C_3A and $C\bar{S}$ reactions continue until all $C\bar{S}$ is consumed, generally within 24 hours. Then, any remaining C_3A will react with the ettringite to form monosulfate (Figure 5-24). Monosulfate is also a C-A- \bar{S} -H. It is commonly referred to as the Afm phase

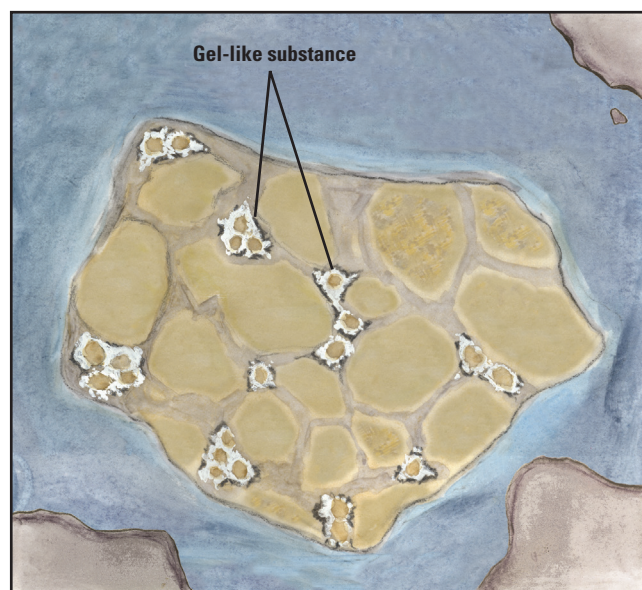

Figure 5-23. Gel-like C-A- \bar{S} -H limits water’s access to cement particles

where the “m” symbolizes “monosulfate,” or one $C\bar{S}$ molecule in the C-A- \bar{S} -H structure. This reaction continues as long as calcium aluminate, ettringite, and water are available. It has little effect on the physical characteristics of concrete but is a component of all hardened cement paste.

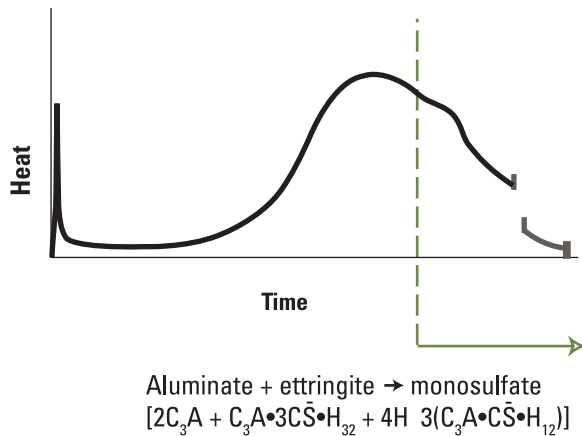

Figure 5-24. After $C\bar{S}$ is consumed, remaining C_3A reacts with ettringite

Ground Limestone Reactions

Ground limestone in PLC undergoes a chemical reaction to form carboaluminates (Tennis et al. 2011). However, these hydration products are a minor contributor to the strength and durability of the hardened cement paste. Ground limestone in PLC primarily serves as nucleation sites for the primary products of hydration. The presence of more nucleation sites tends to increase the overall rate and efficiency of the hydration process.

Factors Affecting Hydration Rates

The rate of stiffening of concrete from plastic to solid, and the subsequent increase in strength, both depend on the rates of the chemical reactions involved in cement hydration. These in turn are influenced by the following:

- Composition of the cement (e.g., increasing alkali contents accelerate hydration)
- Cement fineness (finer cements hydrate faster)
- Mixture proportions (lower w/cm ratios accelerate setting)
- Temperature (higher temperatures accelerate hydration reactions)
- Admixtures (water reducers retard some reactions and accelerate others; see [Potential Materials Incompatibilities](#) later in this chapter)

Reactions of Supplementary Cementitious Materials

Key Points

- The basic chemical components of SCMs are similar to those of portland cement.
- In general, SCMs tend to hydrate at a slower rate and extend the duration of hydration.
- Pozzolans react with CH to form C-S-H, with a positive effect on later-age strength gain and low permeability.
- The use of SCMs to complement portland cements has become increasingly common in concrete mixtures for pavements.
- It is important to test mixtures containing SCMs to ensure they are achieving the desired results, verify the correct dosage, and detect any unintended effects.

SCMs are almost always included in today’s concrete mixtures. They are used to replace some of the portland cement and to affect concrete properties in specific ways (see [Supplementary Cementitious Materials in Chapter 4](#)). SCMs are composed of generally the same elements as portland cement (Figure 5-25).

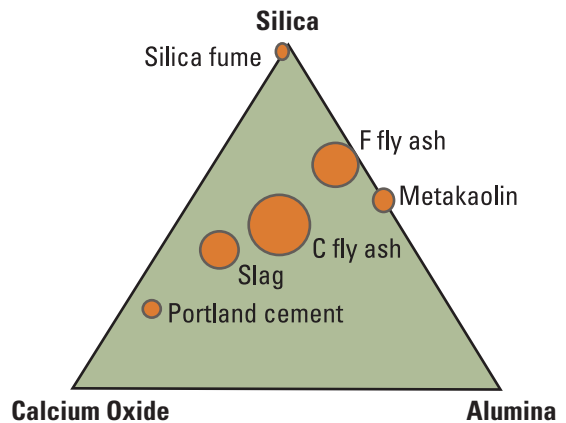

Figure 5-25. Ternary diagram illustrating the basic chemical composition of various SCMs compared to portland cement

Mixtures containing SCMs should be tested to determine the following:

- Whether the SCM is achieving the desired result
- Whether the replacement level is correct to achieve the desired effect
- Whether any unintended effect is occurring, such as a significant delay in early strength gain

It is also important to remember that SCMs may react differently with different cements.

Hydraulic Supplementary Cementitious Materials

Hydraulic cements hydrate, set, and harden when mixed with water. Slag cement and most Class C fly ashes are SCMs with hydraulic properties.

Hydration of systems containing hydraulic SCMs is generally slower than portland cement-only mixtures.

Pozzolanic Supplementary Cementitious Materials

Pozzolans include Class F fly ash, calcined clay, calcined shale, metakaolin, and silica fume. Silica fume is not common in mainline paving but is used in bridge deck mixtures. Class C fly ash also has pozzolanic characteristics.

Pozzolanic materials require a source of CH to hydrate. When pozzolans are included in concrete mixtures, they react with CH to form C-S-H (Figure 5-26). Pozzolans can have a positive effect on strength gain and concrete permeability.

Pozzolanic reactions are slower than cement hydration, so setting times may be longer and strength development is often slower. However, slower hydration can reduce the risk of cracking in some cases. In addition, pozzolanic reactions continue longer, leading to greater long-term concrete strength.

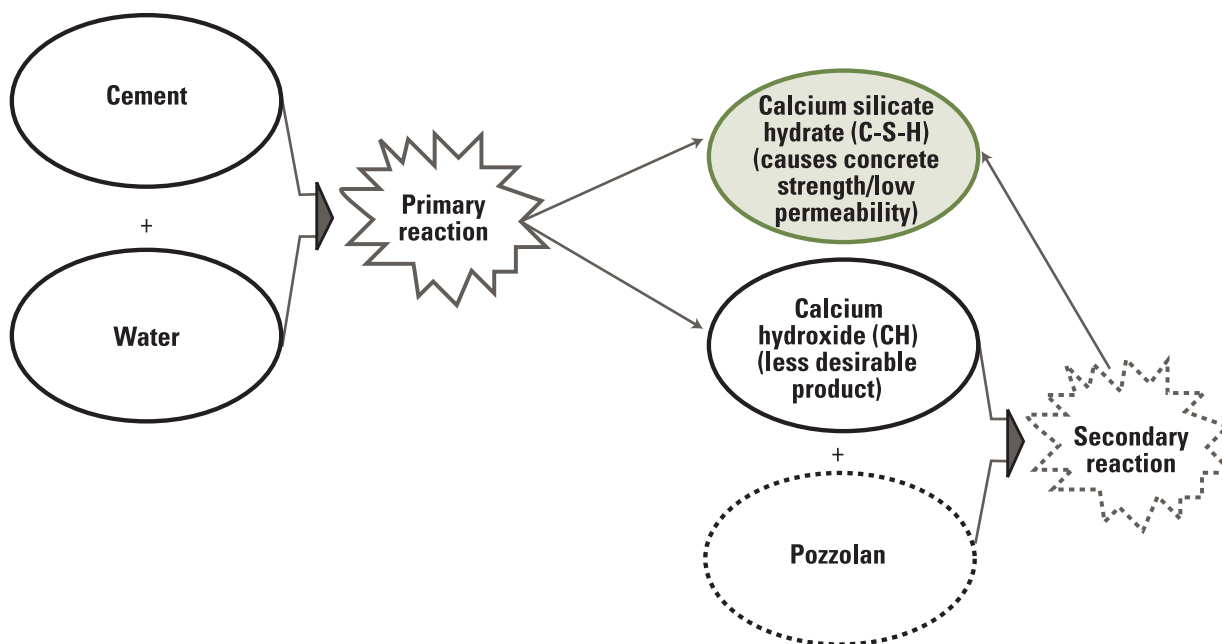

Figure 5-26. Effect of pozzolans on cement hydration

Cements for Concrete Pavements: A Durable Tradition

Durability is a hallmark of concrete pavements. In fact, some concrete pavements constructed in the early 1900s are still in service today.

Over the years, cements for concrete have changed and improved to meet the various needs of the construction and pavement industries. In addition, the construction industry has made use of SCMs that enhance the performance of the concrete.

Changes in Portland Cement

In response to the construction industry's desire to shorten construction times by accelerating concrete strength gain, cement manufacturers have made appropriate changes in portland cement chemistry. Over several decades, portland cement manufacturers have increased C_3S contents and reduced C_2S contents. In the early 1900s, the proportions were about the same. Today, the amount of C_3S is about three times the amount of C_2S in Type I cement.

As shown in Table 5-4, hydration of C_3S begins sooner than hydration of C_2S , and C_3S hydration is primarily responsible for concrete's early strength gain. C_2S reactions are primarily responsible for concrete's later strength gain and for continuing reduction in concrete permeability.

Today's cements are also generally finer than they were in the early 1900s. Smaller particles have greater specific surface area and therefore hydrate and gain strength more quickly. Finer particles also result in greater heat of hydration. In warm or hot weather, fine particle cements may need to be retarded to achieve the required finished product.

Today's high early-strength cements deliver the performance required for most building and commercial uses. They also help the concrete paving industry meet motorists' demands to open new pavements to traffic more quickly. Concrete pavement strengths after 7 and 14 days are much greater than they were years ago; after 28 days, gains in concrete strength and reductions in permeability are smaller than historically documented.

PLC includes ground limestone, commonly interground with the clinker. The process of grinding with limestone typically results in a higher Blaine fineness because the limestone is softer and grinds preferentially. When limestone is added separately (i.e., not interground), the resulting blend may not have the same increase in fineness (Tennis et al. 2011). Because the ground limestone accelerates the rate of hydration, the dormant period can be slightly reduced.

Supplementary Cementitious Materials

In the history of concrete pavements, SCMs are relative newcomers. These materials are primarily byproducts of manufacturing processes and when used properly, SCMs are useful complements to portland cement in concrete for paving applications.

Pozzolan reactions are beneficial because they consume CH to produce additional C-S-H. CH contributes relatively little to concrete strength, while C-S-H is the primary contributor to improved concrete strength and permeability. Pozzolan reactions also generally hydrate slower initially and reduce the early heat of hydration. Pozzolan reactions continue for a longer time, however, adding significantly to long-term strength gain and permeability reduction.

Good Practices

Regardless of the cementitious system used, a sufficiently low w/cm ratio is critical to achieving the strength and durability needed for concrete pavements.

In addition, good curing practices are more important than ever because SCMs react slower and are sensitive to poor curing. Good curing practices help ensure the continuation of cement hydration reactions that add to concrete's long-term strength and reduce its permeability. Good curing practices include thoroughly covering the concrete surface with curing compound or wet coverings and protecting the curing compound from equipment and traffic as long as possible.

Table 5-4. Comparison of C_3S and C_2S reactions

	Hydration reactions	Hydration products	Effect on concrete
Alite (C_3S) $2C_3S + 6H \rightarrow C-S-H + 3CH$	<ul style="list-style-type: none"> • Begin sooner • Are more rapid • Slow sooner 	Forms more CH (relative to C_2S)	<ul style="list-style-type: none"> • Early strength gain • Early reduction in permeability
Belite (C_2S) $2C_2S + 4H \rightarrow C-S-H + CH$	<ul style="list-style-type: none"> • Are slower • Continue longer 	Forms less CH (relative to C_3S)	<ul style="list-style-type: none"> • Later strength gain • Later reduction in permeability

Impact of Hydration

Implications of Cement Hydration for Construction Practices (Fresh Properties)

See Chapter 8.

Stage 1: Mixing	Stage 2: Dormancy	Stage 3: Hardening	Stage 4: Cooling	Stage 5: Densification
<p>If using dump trucks or agitator trucks, mix the materials and place the mixture into the transport vehicle. Watch for stiffening during transportation (see early stiffening under Potential Materials Incompatibilities Central Laboratory [Prequalification] Tests later in this chapter).</p> <p>If using ready-mix trucks, place materials into truck and mix during transport.</p> <p>In both cases, ensure adequate mixing is provided in accordance with applicable specifications.</p>	<p>Transport, place, finish, and texture the concrete during the dormant period, before initial set, while the concrete is cool, plastic, and workable.</p> <p>Use transport methods and equipment that will prevent segregation.</p> <p>If visible bleeding occurs, finish the surface after bleeding has stopped and bleed water has evaporated. Do not work bleed water back into the surface, because it increases porosity and permeability of the surface layer. In hot weather, bleeding may be helpful in reducing plastic shrinkage cracking.</p> <p>If necessary (e.g., in hot, windy weather) apply a polymeric evaporation retarder before finishing to reduce the potential for plastic shrinkage cracking.</p>	<p>After stiffening begins, do not work, vibrate, or consolidate the concrete. Segregation of the ingredients at this point will be permanent.</p> <p>Thoroughly apply curing compound to the concrete surface and edges as soon as possible after finishing to reduce the rate of water evaporation from the concrete. Protecting the concrete with curing compound is critical because it allows for continued hydration, which results in stronger, less permeable concrete. When water evaporates from the concrete, more cement remains unhydrated and fewer products form. Also, water evaporation leaves capillary pores behind, reducing concrete's durability by increasing permeability, making the concrete more susceptible to freeze-thaw damage and attack by aggressive fluids.</p> <p>During this stage, prepare joint sawing equipment. Beginning at final set, start checking concrete for readiness for saw cutting.</p>	<p>To prevent random cracking due to build-up of tensile stresses, saw joints during the sawing window:</p> <ul style="list-style-type: none"> The sawing window begins when the concrete is strong enough not to ravel when sawed and ends before the concrete cracks in front of the saw, typically no later than 24 hours after placement. Using conventional saws, the sawing window generally begins after final set but before the concrete heat reaches a maximum. The window ends after the heat reaches a maximum—how long after depends on the specific mixture (e.g., cement, SCMs, ambient temperatures). For early-age saws, the window may begin at or slightly before final set (Stage 3) and will end earlier than for conventional sawing. <p>Cover the slab, especially if temperatures will cool significantly during the first night. Insulation prevents extreme temperature and moisture variations within the slab that can lead to curling, warping, and related cracking. Maintaining the slab moisture and temperature is the essence of proper curing, and insulation provides the necessary protection.</p>	<p>Keep concrete thoroughly covered and protected with curing compound as long as possible, at least for the first 72 hours after mixing.</p> <p>The longer the curing compound remains in place (i.e., the concrete remains protected from equipment and construction traffic), the more moisture will be retained in the concrete for hydration, increasing strength development and reduction of permeability.</p>
Lasts about 15 min	Lasts about 2–4 hr	Lasts about 2–4 hr		Can continue for years

Potential Materials Incompatibilities

The risk of incompatibilities occurring is higher

- When using finer cementitious materials.
- At low water/cementitious materials ratios.
- At high temperatures.

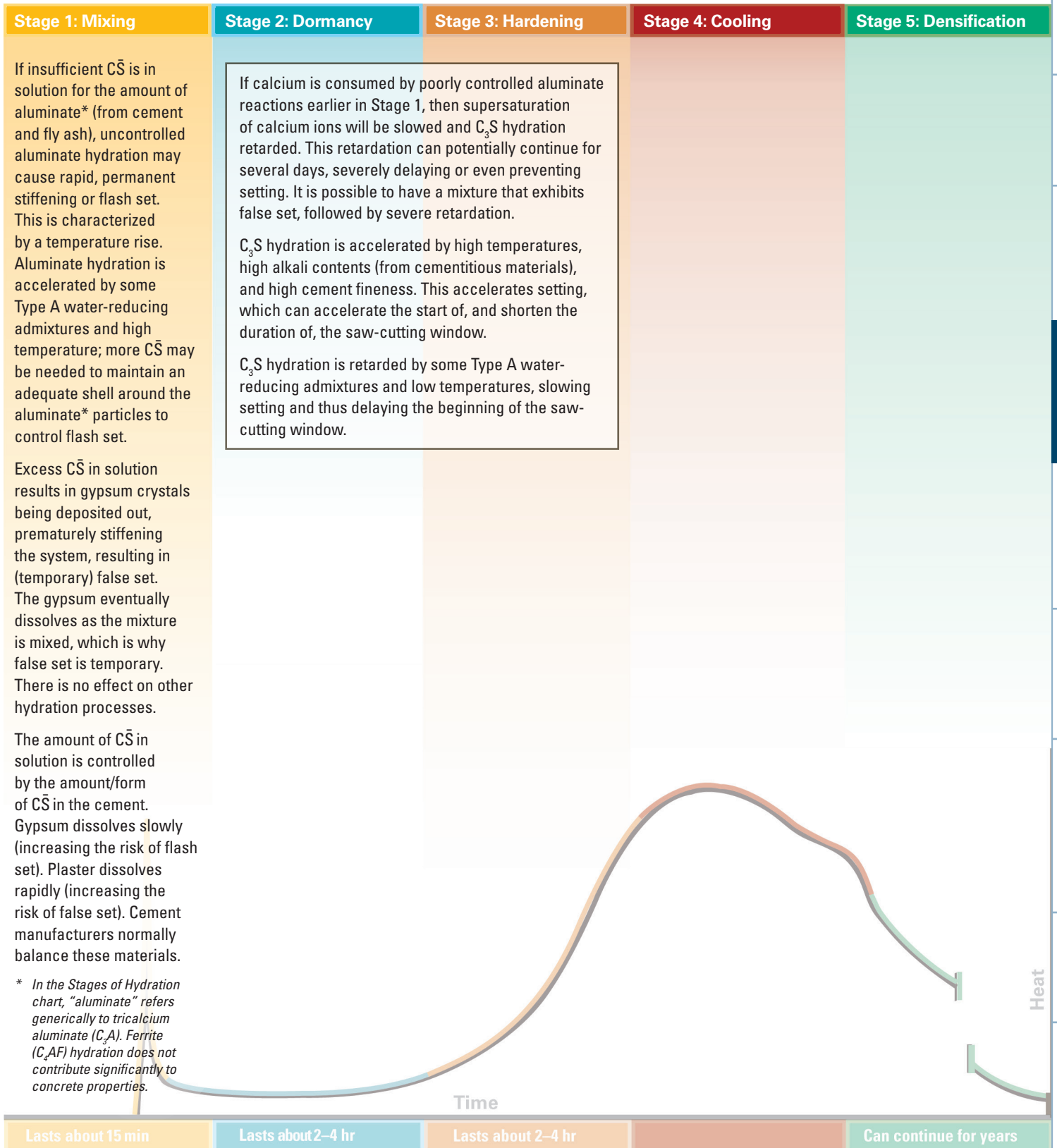

Key Points

- Some combinations of normally acceptable materials may be incompatible. That is, they react with each other in ways that cause unexpected changes in stiffening or setting that ultimately may compromise the concrete system.
- Incompatibility is normally the result of chemical interactions between the cementitious materials and chemical admixtures.
- The amount and form of $C\bar{S}$ are important for an appropriate balance with C_3A to prevent setting and stiffening problems.
- Changing the source or amount of one of the reactive ingredients may stop the problem from recurring.
- Some incompatibility problems can be exacerbated with increasing temperatures.
- Testing the mixture at the expected temperature is strongly recommended.

Some combinations of materials may be prone to problems with setting, stiffening, or other issues. Such problems can occur even if all materials meet their specifications and perform well when used alone or with other materials. This phenomenon is generally known as incompatibility.

Incompatibility is important because small changes in the chemistry of materials, or even in temperature, can make a mixture acceptable in one batch of concrete behave in an unacceptable manner in the next batch, causing problems in placing, compacting, or finishing that are often perceived to be unpredictable and uncontrollable.

Incompatibility is likely occurring because we are using more combinations of cementitious materials, chemical admixtures, and other materials while asking more of the concrete. The sections are thinner, placing rates are higher, turnaround times are faster, strengths are higher, and the construction season is starting earlier and ending later so that concrete is being placed in more extreme weather conditions. It is also becoming common for materials sources to be changed on a given project without running trial mixtures or materials tests.

There is no single mechanism behind the wide range of effects that are occurring. Many of the mechanisms are complicated and interactive and may require expert evaluation if they occur in the field.

Typical results of incompatibility may include one or more of the following:

- The concrete stiffens much too quickly, preventing proper consolidation or finishing work.
- The concrete sets and gains strength before joints can be cut.
- The concrete does not set in a reasonable time, increasing the risk of plastic shrinkage cracking and late sawing.
- The concrete cracks randomly despite normal efforts to prevent it.
- The air-void system is adversely affected, compromising the concrete's resistance to salt scaling and freezing and thawing distress or decreasing concrete strength.

For example, a mixture contains Class C fly ash, portland cement, and chemical admixtures, and the combined chemistry of the system causes accelerated stiffening and setting. When one of the materials—fly ash, cement, or admixture—is changed, the concrete setting behavior is normal. Actual cases have been reported where the mixture is satisfactory at 70°F but cannot be compacted in the paver at 80°F.

Following are brief discussions of some of the incompatibility problems that can occur.

Stiffening and Setting

Incompatibility issues related to stiffening and setting are generally the result of a sulfate imbalance, although other factors can contribute.

Sulfate-Related Setting and Stiffening

In the first 15 minutes, cement hydration is a delicate balance between the C_3A and $C\bar{S}$ in solution. If the balance is right, the sulfate controls the hydration rate of tricalcium aluminate. If the balance is not right, stiffening and setting problems can occur (Figure 5-27).

Too Much or Too Little Sulfate

The amount of $C\bar{S}$ in solution in hydrating cement is critical.

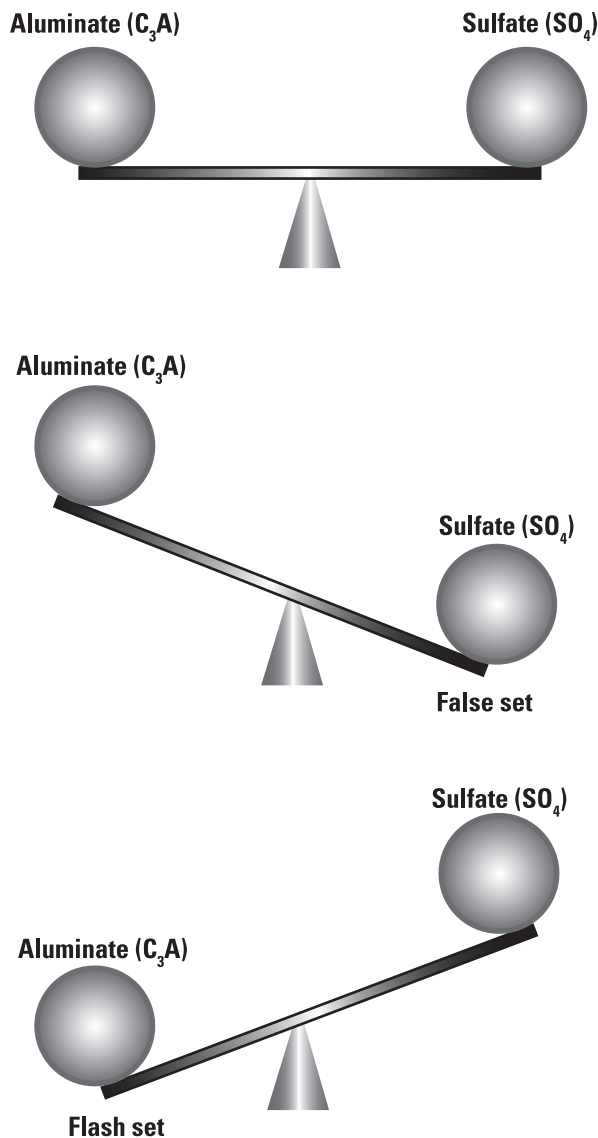

CTLGroup, used with permission

Figure 5-27. Early cement reactions are a balance of C_3A and $C\bar{S}$ in solution where excess of either will cause unexpected setting

FLASH SET

If there is insufficient $C\bar{S}$ in solution, the C_3A reacts quickly with water to form C-A-H (see Table 5-3). This reaction generates a large amount of heat, and the fast build-up of C-A-H results in flash set: immediate and permanent hardening of the mix.

FALSE SET

Too much $C\bar{S}$ in solution may precipitate out as solid gypsum, causing temporary stiffening of the mixture, or false set. If mixing continues, the gypsum will redissolve and the stiffening will disappear.

Form of $C\bar{S}$

The form of $C\bar{S}$ (i.e., gypsum, hemihydrate, or anhydrite) in the cement is also critical because it affects the amount of $C\bar{S}$ ions in the solution. Hemihydrate dissolves faster than gypsum and is therefore useful in preventing flash set. However, cement containing too much hemihydrate will result in too much $C\bar{S}$ in the solution, upsetting the balance and resulting in false set, as discussed above. The presence of anhydrite may also upset the $C\bar{S}$ balance required because it dissolves slowly and may provide insufficient $C\bar{S}$ in the solution to control cements with high C_3A contents.

Other Stiffening and Setting Incompatibilities

Other factors that can affect stiffening and setting incompatibilities include silicate reactions, SCMs, water reducers, cement fineness, temperature, and w/cm ratio.

Silicate Reactions

Most of the strength development in concrete is due to hydration of the silicates in cementitious materials to form C-S-H. In general, these reactions start when calcium ions are supersaturated in the solution. If calcium has been consumed during the initial stages of hydration, such as in uncontrolled C_3A hydration, it is possible the silicate reactions may be significantly retarded. Silicate reactions can also be affected by the presence of other materials in the mixture, as discussed in the following paragraphs.

Supplementary Cementitious Materials Incompatibilities

In cases where the SCM is a pozzolan, the overall hydration reaction is slowed because the pozzolanic reaction lags the reaction of portland cement. A pozzolan requires CH to react and the CH is first produced by the initial portland cement reaction. This two-stage process leads to a slower strength gain. A similar effect is seen with slag cement where CH serves to activate the slag hydration reaction. Although both may have a slower rate of strength gain initially, the reaction time is extended, leading to final strengths that meet or exceed the strength attained with portland cement only.

An SCM containing additional C_3A , such as a high-calcium fly ash, can compromise the aluminate-sulfate balance, causing or exacerbating the stiffening and setting problems discussed previously. It may therefore be desirable to use factory-blended cements rather than site-blended cements because the manufacturer can optimize the sulfate form and content for the whole cementitious system.

Water Reducer Incompatibilities

Some water-reducing admixtures will interfere with the hydration rates of cement compounds. Lignin-, sugar-, and triethanolamine (TEA)-based products (normally Type A or B) have the combined effect of accelerating aluminate reactions and retarding silicate reactions. The use of such an admixture may tip a marginally balanced cementitious system into incompatibility.

Some Type A water reducers accelerate aluminate reactions. A system that has just enough $C\bar{S}$ to control normal aluminate reactions can therefore be thrown out of balance. Aluminate reactions are then uncontrolled and workability is reduced. Adding more admixture with the mixing water to boost workability likely exacerbates the problem, possibly leading to an overdose with its attendant problems, such as retardation of the silicate reactions.

One solution is to delay adding the water-reducing admixture until the early aluminate reactions are under control. The length of the delay will have to be determined for the specific mixture.

In addition, the same water-reducing admixtures retard the silicate reactions, delaying setting and slowing strength gain (Figure 5-28).

It is therefore feasible that a system containing certain water reducers will exhibit classic early stiffening because of uncontrolled aluminate hydration, followed by severe retardation of final set because of slowed silicate reactions. This has been observed in the laboratory and in the field.

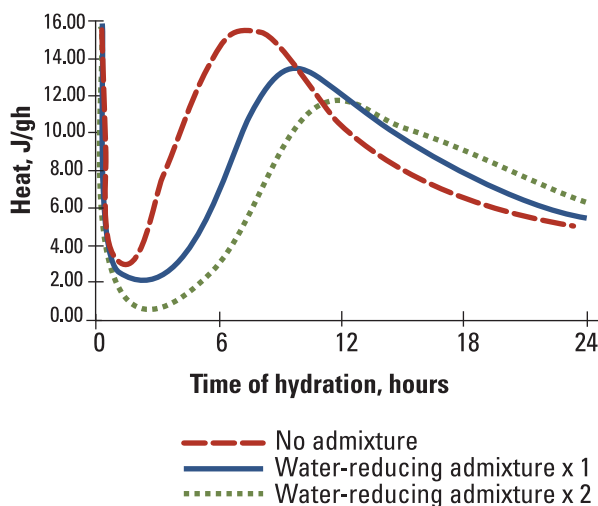

CTLGroup, used with permission

Figure 5-28. Plot of heat generated by cement hydration of cement pastes containing varying amounts of lignosulfonate-based water-reducing admixture

Cement Fineness

Cement fineness influences reaction rates. The finer the cement, the greater the rates of reaction and the greater the risk of an unbalanced system. Finer cements require a higher $C\bar{S}$ content and perhaps a higher hemihydrate/gypsum ratio.

Temperature

The solubility and reactivity of all cement compounds are strongly influenced by temperature, with higher temperatures generally increasing solubility (except for $C\bar{S}$) and accelerating reaction rates. Increasing temperature decreases the solubility of $C\bar{S}$, thus reducing the amount of $C\bar{S}$ in solution available to control the aluminate reactions. A change of as little as 10°F can tip a mixture from being workable to exhibiting early stiffening. In warmer weather, more hemihydrate is needed to control rapid C_3A reactions.

Water/Cementitious Materials Ratio

The severity of these effects is also related to the w/cm ratio. Lower water contents effectively mean the cement grains are closer together. Therefore, the early hydration products have to fill less space before stiffening results, so early stiffening may occur. The same mixture at a higher w/cm ratio (e.g., 0.42), with greater particle spacing, may not exhibit the same symptoms as a mixture with a low w/cm ratio (e.g., 0.37). A w/cm ratio below about 0.38 is not recommended for slipform paving.

Air-Void System Incompatibilities

There have also been reports of accumulations of air voids forming around aggregate particles, known as clustering (Figure 5-29). This results in reduced strength and increased permeability.

Research has indicated (Kozikowski 2005) this is most likely to occur with the use of non-Vinsol air-entraining admixtures (AEAs) and when water is added to the mixture after initial mixing. Extended mixing will exacerbate the problem.

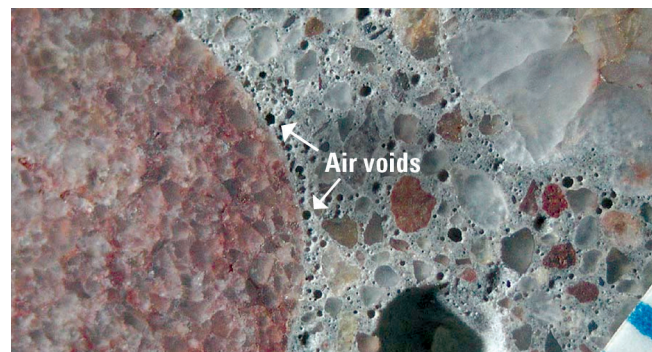

Figure 5-29. A typical example of air voids clustered around an aggregate particle

To avoid this problem, check the air-void system of hardened concrete in trial mixes prepared under field conditions, mimicking expected haul times.

Testing for and Prevention of Incompatibilities

The most reliable way to detect whether a mixture is likely to be problematic is to conduct a series of tests and trial batches on the materials at the field temperature. Laboratory tests must be run sometime before construction begins to prequalify materials planned for the project. Field tests (i.e., materials-acceptance tests) should be run as materials are delivered to the site to ensure that site materials are similar to prequalified materials. Preferably, materials-acceptance tests should be run the day before batching is planned; although, at the height of construction, results may be needed within a few hours.

What to Test

A suggested test protocol is summarized in Table 5-5. In many cases, there is no single pass/fail limit because what is acceptable in one system or environment is not acceptable in another. It is recommended that test results be tracked over time, and a significant change in a test result may indicate potential problems. It is recommended that as many of these tests as practical be conducted at the prequalification stage so that a point of reference is available for comparison with tests conducted during construction. A test result that is out of the ordinary may be a problem with the testing or with the material. Such data should therefore be reviewed with an understanding of the limitations and potential errors in testing. Interpreting the results can be difficult and may need expert input.

The decision about how many of these tests to perform will be based on the economics of the project, including

the value of the project, probability of failure (i.e., is the cementitious system stable?), cost of testing, and cost of failure. Many problems can be avoided by regularly monitoring slump loss, unit weight, set time, and admixture dosages. Significant changes in any of these parameters will indicate the need for more intensive examination of the materials at hand.

Central Laboratory (Prequalification) Tests

Factors to monitor generally include mini-slump, temperature rise, shear stress, rate of stiffening, and early cracking.

Mini-slump

The mini-slump cone test monitors the area of small-slump cone samples made using paste at selected time intervals. The test is effective at identifying systems prone to early hydration problems (Kantro 1981). The reproducibility between labs is reportedly low.

Isothermal Calorimetry

The energy required to maintain a hydrating paste mixture is monitored in an isothermal calorimeter. Changes in the timing or magnitude of the temperature rise, or the shape of the heat-energy-versus-time plot, will flag potential problems in the silicate reactions (Wadso 2004). ASTM has developed a practice for this application.

Shear Stress Increase

Measurement of the shear stress increase with time in a parallel plate rheometer using paste is showing promise as a method to monitor silicate hydration processes.

Rate of Stiffening

The ultrasonic P-wave test allows measurement of the rate of stiffening of a mixture in the laboratory and the field.

Table 5-5. Recommended tests and their applications

	Stiffening and setting	Cracking	Air-void system
Laboratory tests	<ul style="list-style-type: none"> • Materials chemistry • Calorimetry • Minislump • Rheometer • Time of set (ASTM C191) • Stiffening (ASTM C359) 	<ul style="list-style-type: none"> • Materials chemistry • Ring test • Time of set 	<ul style="list-style-type: none"> • Materials chemistry • Air-void analyzer • Hardened air (ASTM C457) • Clustering index
Field tests	<ul style="list-style-type: none"> • Slump loss • Time of set (ASTM C403) • Ultrasonic P-wave • Semi-adiabatic temperature measurement 	<ul style="list-style-type: none"> • Time of set • Semi-adiabatic temperature measurement • Ultrasonic P-wave 	<ul style="list-style-type: none"> • Foam index • Foam drainage • Unit weight (ASTM C138) • Air content (ASTM C231) • Air-void analyzer

Source: Taylor et al. 2006

Early Stiffening

The method described in ASTM C359/AASHTO T 185 is being used in some laboratories to indicate potential problems in the early aluminate reactions. Interpretation of the results must be undertaken with care and understanding. ASTM is developing a practice for this application.

Ring Test

The ring test is a measure of when a fully restrained concrete sample cracks. Earlier cracking may be considered an indicator of higher risk of cracking in the field.

Field Laboratory (Monitoring) Tests

Factors to monitor generally include the manufacturer’s mill certification, semi-adiabatic temperature of the mixture, concrete slump loss and setting time, uniformity of the air-void system, and air-void clustering.

Mill Certification

The chemical analysis provided on the manufacturer’s mill certification is the simplest characteristic to monitor. The certification provides the chemistry of the cement or SCM. Changes in total calcium, CS , alkali, C_3A , C_3S , or C_2S may indicate potential problems. Likewise, other important characteristics such as the Blaine fineness and setting times (i.e., Vicat test) are provided. Significant changes in any of these characteristics may lead to performance issues. However, note that the standard mill certification provides a 30-day average of the provided test results. Depending on the mill production and the consumption rate, fluctuations in individual shipments may not be reflected in the mill certification. This is especially true for fly ash.

Semi-Adiabatic Temperature Measurement

This test monitors the temperature of paste, mortar, or concrete mixtures in sealed containers (e.g., Dewar flasks or insulated cups). Changes in the timing or magnitude

of the temperature rise, or the shape of the heat-versus-time plot, will flag potential problems in the silicate reactions (Figure 5-30) (see Semi-Adiabatic Calorimetry in Chapter 9).

Concrete

For this test, make concrete batches and monitor slump loss with time as well as setting time (ASTM C143).

Foam Index (Dodson 1990, Sutter 2013) and Super Air Meter (AASHTO TP 118)

These tests provide guidance on the uniformity and stability of the air-void system (see Air-Void System in Chapter 6). Correlation with field concrete still has to be established.

Clustering Index Test (Kozikowski 2005)

This is a measure of the severity of air void clustering around coarse aggregate particles. High values are associated with a reduction of strength.

Potential Solutions to Incompatibilities

If problems are observed in the tests or in the field, then one or more of the following actions may resolve them:

- Reduce the concrete temperature by cooling the materials and/or working at night
- Seek a fly ash with lower calcium content
- Reduce fly ash replacement level
- Delay admixture addition
- Change the type of chemical admixture
- Change the source of cement
- Increase mixing time

Seek expert advice to establish what the root cause of the problem is so the correct remedial action can be taken.

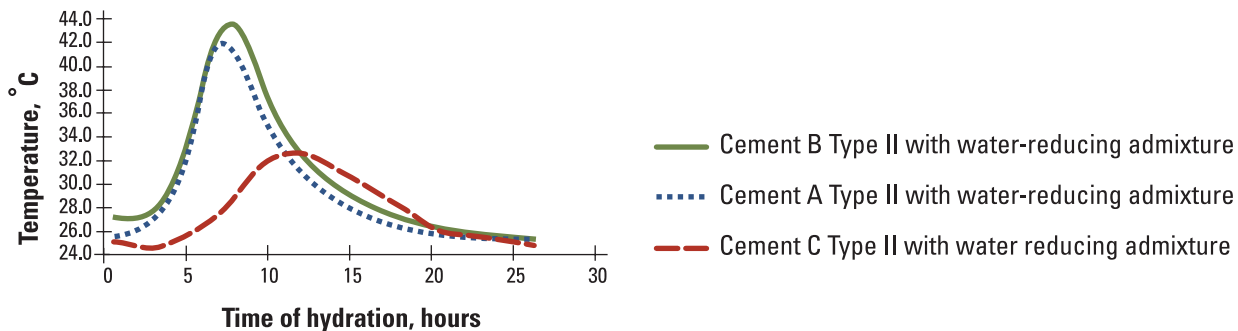

Gary Knight, Lafarge/Holcim, used with permission

Figure 5-30. A set of field calorimetry data with three different cements and the same dosage of water-reducing admixture, including one set showing clear retardation and low heat output consistent with delayed setting and slow strength gain

Implications of Cement Hydration for Hardened Concrete Properties

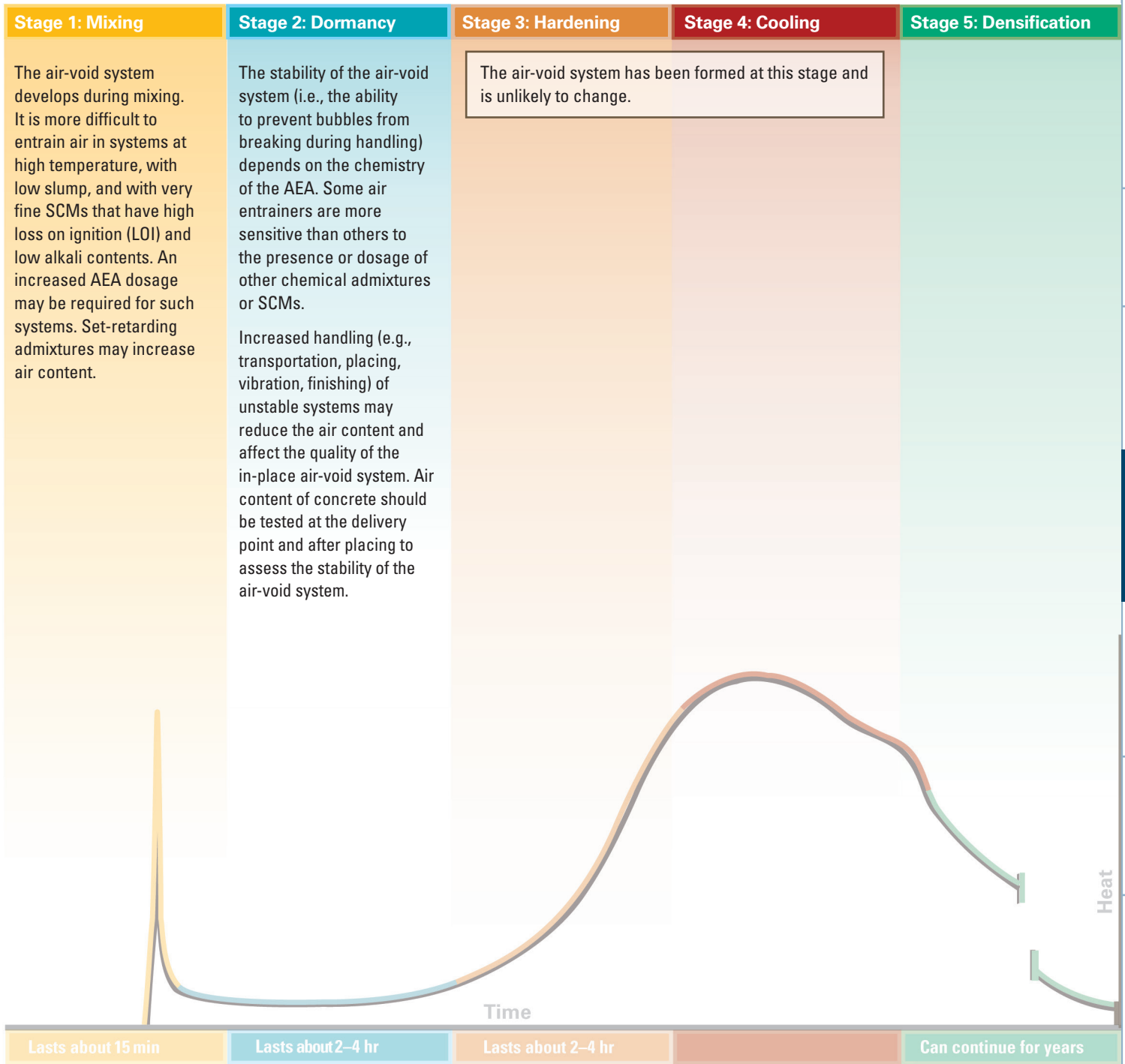

Air-Void System

A good air-void system is a uniform distribution of small, stable bubbles in the finished concrete, and it is necessary for concrete durability. See Air-Entraining.

Admixtures in Chapter 4, Resistance to Freezing and Thawing in Chapter 6, and Effects of Chemical Admixtures in Chapter 5.

Pores

In general, water that does not react with the cementitious materials will either remain in the concrete or evaporate out when the concrete dries. The space occupied by unreacted water is the capillary pore system. The volume of capillary pores strongly influences concrete strength and durability because the pores provide a zone of weakness for crack growth and a route for aggressive solutions.

Ideally, most space occupied by water in the mix will be filled with hydration products. This requires sufficient cement (low water/cementitious materials ratio) and protection from moisture loss until sufficient hydration has occurred (good curing practices).

Permeability

One characteristic of durable concrete is low permeability. Salts and other harmful substances cannot easily penetrate such concrete, and it is less susceptible to freezing and thawing damage.

To ensure that new concrete pavements have a low permeability, it is important to provide the right conditions for hydration to continue sufficiently. Providing the right conditions includes retaining mixture water (i.e., losing as little as possible to evaporation) and protecting the concrete from high temperatures that accentuate free water evaporation or low temperatures that slow or halt the hydration reaction.

Reduce moisture loss from the concrete by thoroughly applying curing compound or wet coverings after finishing or at the time of initial set, depending on the rate of bleeding, and then protecting the curing compound from traffic for as long as possible. In hot weather, evaporation retarders may also be applied between initial placement and finishing to further reduce moisture loss. In cold weather, protect the concrete from heat loss by covering it with insulating blankets.

In general, water that does not react with the cementitious materials will either remain in the concrete or evaporate out over time. The space occupied by free water is the capillary pore system. The volume of capillary pores strongly influences concrete strength and durability because the pores provide a zone of weakness for crack growth and strongly affect permeability.

Ideally, most water-filled space in the mixture will be filled with hydration products. This requires a low w/cm ratio and protection from moisture loss until sufficient hydration has occurred (i.e., good curing practices).

Ground limestone in PLC primarily serves as nucleation sites for the primary products of hydration. Because the limestone particles are interstitial between the cement grains, they tend to assist in filling the water-filled space with hydration products and therefore lead to a denser hardened cement paste.

Concrete Strength Gain, Tensile Stress, and the Sawing Window

During cement hydration, as the hydration products accumulate, the concrete develops its strength. Compressive strength is the ability to resist forces that push the concrete together (compression); tensile strength is the ability to resist forces that pull it apart (tension).

Concrete develops significant compressive strength, which makes it an ideal material for pavements that support heavy loads. Concrete's tensile strength, however, is only about one-tenth its compressive strength. With changing internal moisture and temperature, concrete experiences volume changes, but the pavement base, among other things, restrains the concrete movement. This restrained movement sets up tensile stresses, or tension, within the concrete.

At some time after final set, the growing tensile stresses will likely exceed the concrete's tensile strength, causing the concrete to crack. Sawing joints relieves tensile stresses and prevents random cracking by reducing the panel sizes, thus reducing the amount of restraint. Joints must be cut during the critical period when the concrete has hardened enough not to ravel along the saw cut but before it has begun to crack randomly. That period is the sawing window. For conventional saws, this is generally soon after final set; for early-age saws, the period may begin at or slightly before final set.

Implications of Cement Hydration for Cracking

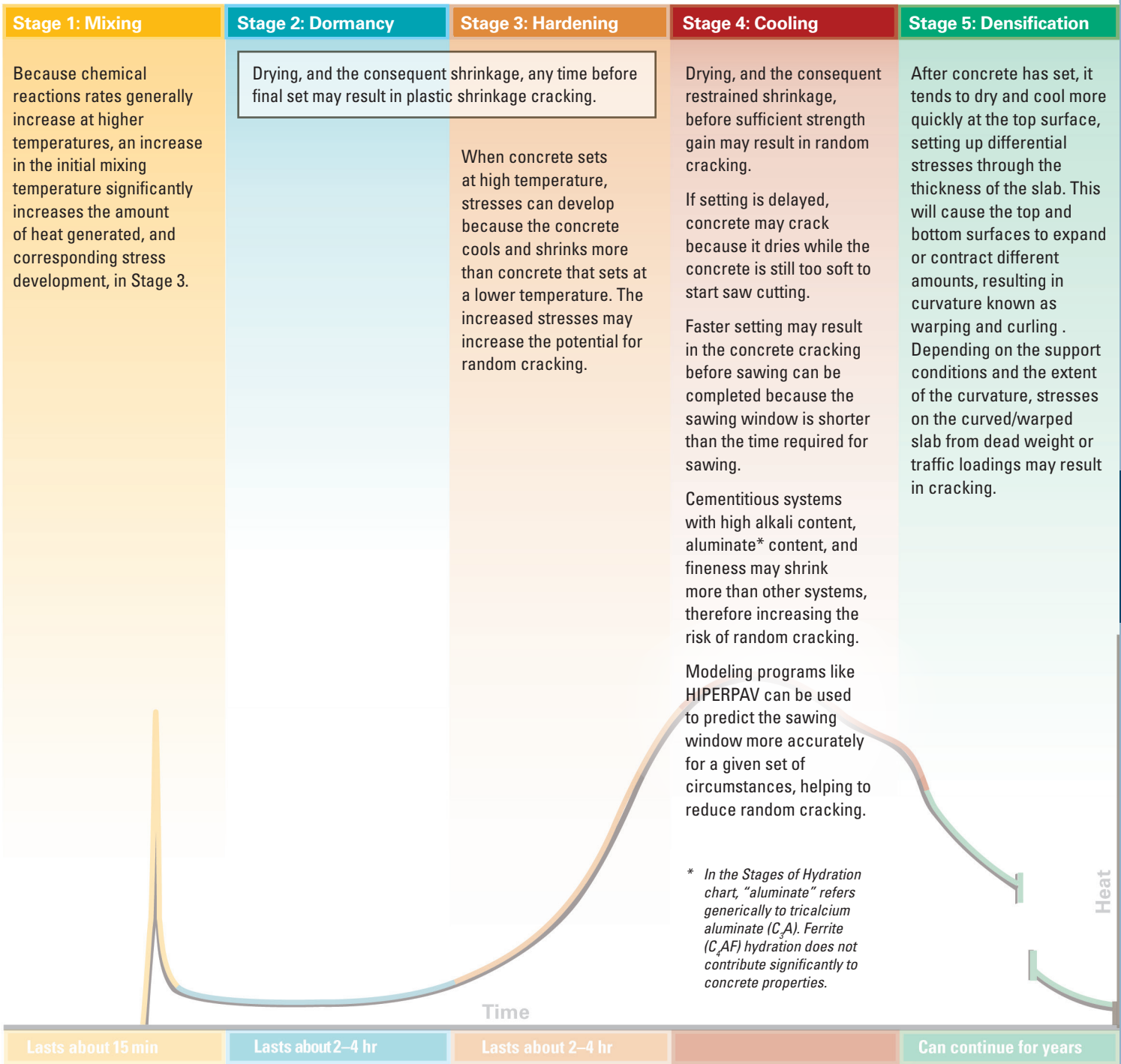

Cracking

Materials tend to expand as they get warmer and shrink when they get cooler. Cement paste tends to change more with temperature changes than does aggregate. Cement paste also shrinks as it sets; drying (i.e., evaporative losses) will exacerbate this shrinkage. Objects that are restrained when they shrink or expand will be stressed, leading to cracking if the stresses exceed the material strength. Restraint comes from any connection with adjacent objects, such as friction with the subgrade. It is therefore desirable to reduce paste content within a given mixture, while

still achieving workability and filling all the voids between aggregate particles.

The volume of aggregate is significantly larger than the volume of paste, and it tends to control the amount of thermal movement of concrete. If aggregate with a low coefficient of thermal expansion (CTE) is used, the risk of cracking problems will decrease (see [Aggregate Coefficient of Thermal Expansion in Chapter 4](#)). Concrete with high paste content and high fines content, due to improper aggregate gradation, will be at higher risk of cracking (see [Early-Age Cracking in Chapter 6](#) and [Crack Prediction with HIPERPAV in Chapter 8](#)).

Stages of Hydration: Details

The Stages of Hydration charts provide more details about hydration and the transformation of concrete from a plastic mixture to a solid slab.

The charts illustrate and explain the following:

- Specific chemical reactions occurring between cement and water at various stages of hydration
- How these reactions
 - Are observed in changes in heat
 - Result in physical changes in the mixture
 - Influence construction practice
- How SCMs change the system
- How chemical admixtures change the system
- How incompatibilities may occur
- Issues related to cracking
- Issues related to the air-void system

These topics are covered in greater depth on the following pages, which focus more on the compounds involved in cement hydration than on the stages.

Primary Hydration Products

The primary products of hydration are as follows:

- Calcium silicate hydrate (C-S-H)
- Calcium hydroxide (CH)
- Ettringite (C-A- \bar{S} -H)
- Monosulfate (C-A- \bar{S} -H)
- Carboaluminate (C-A- \bar{C} -H) (portland-limestone cements only)

The charts on the following pages focus on the formation of C-S-H and CH. These compounds are central to concrete strength and durability.

STAGES OF HYDRATION

Stage 1: Mixing

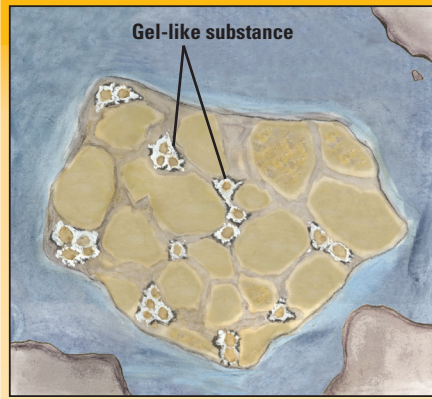

Within minutes of mixing cement and water, the aluminates start to dissolve and react, with the following results:

- Aluminate* reacts with water and sulfate, forming a gel-like material (C-A- \bar{S} -H). This reaction releases heat.
- The C-A- \bar{S} -H gel builds up around the grains, limiting water's access to the grains and thus controlling the rate of aluminate reaction. This gel formation occurs after an initial peak of rapid hydration and heat generation.

Stage 2: Dormancy

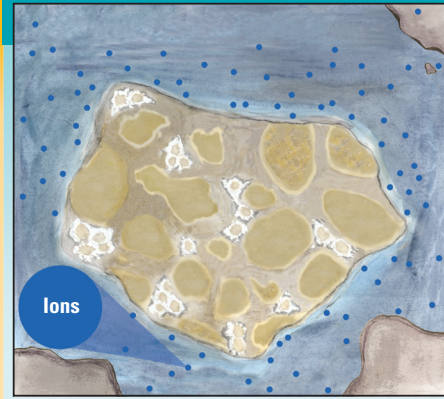

For about two to four hours after mixing, there is a dormant period, during which these events occur:

- The C-A- \bar{S} -H gel is controlling aluminate* reactions. Little heat is generated, and little physical change occurs in the concrete. The concrete is plastic.
- During dormancy, as silicates (C₃S and C₂S) slowly dissolve, calcium ions and OH ions accumulate in solution.

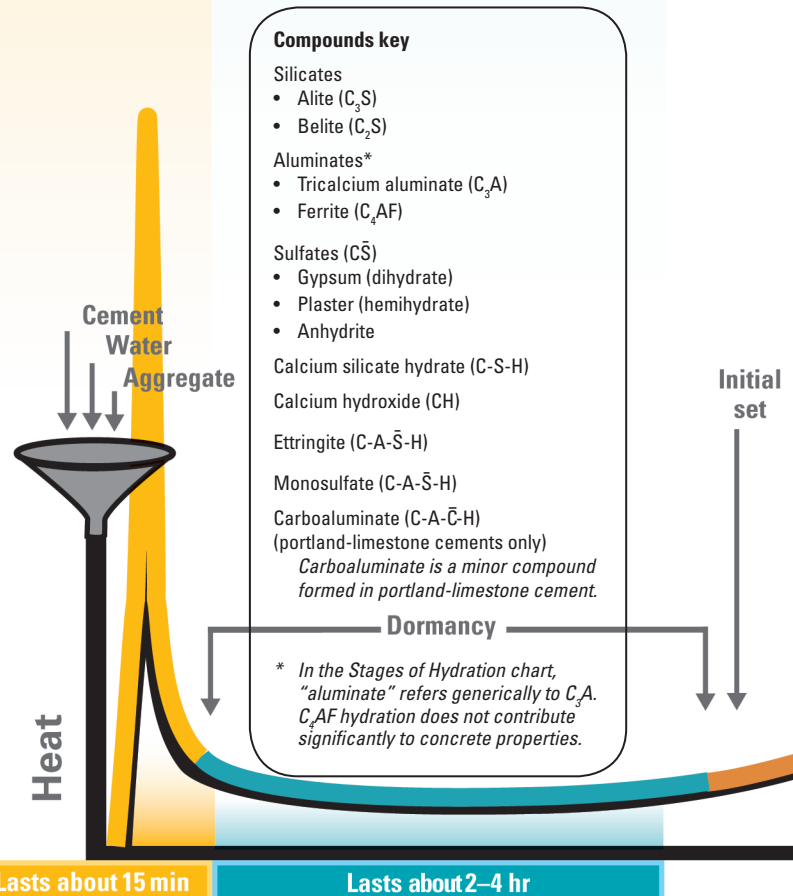

Lasts about 15 min

Lasts about 2–4 hr

Stage 3: Hardening

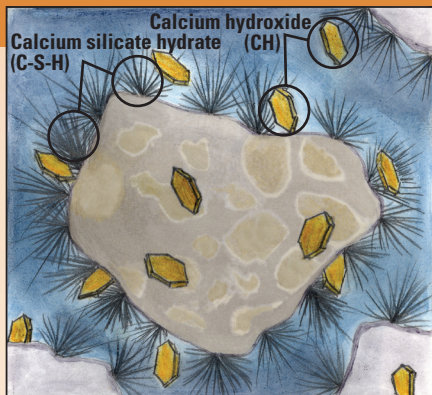

This stage is dominated by C_3S hydration and the resulting formation of C-S-H and CH crystals:

- When the solution becomes supersaturated with calcium ions from dissolving C_3S primarily, fiber-like C-S-H and crystalline CH start to form. These hydration products nucleate on cement grains, SCM particles, and also ground limestone particles in PLC. These hydration reactions generate heat. Meshing of C-S-H with other solids causes the mixture to stiffen and set.

- The increasing heat and stiffening of the cement paste mark the beginning of hydration acceleration, which lasts several hours. Initial set occurs early in this stage.

Final set—Acceleration is characterized by a rapid rate of hydration, significant heat, continued hardening, and strength development.

- The rates of reaction are faster for finer cementitious materials and for systems with higher alkali contents. Slower-reacting systems will react longer and will generally provide a better microstructure in the long run.
- During acceleration, aluminate* and $C\bar{S}$ continue to react, and needle-like ettringite (C-A- \bar{S} -H) crystals form.
- Final set—about when the concrete is hard enough to walk on—occurs before heat energy peaks from C_3S reactions begin to slow.
- After final set, tensile stresses start to develop due to temperature and drying effects, the mixture's increasing stiffness, and the slab's friction with the pavement base.

Lasts about 2–4 hr

Stage 4: Cooling

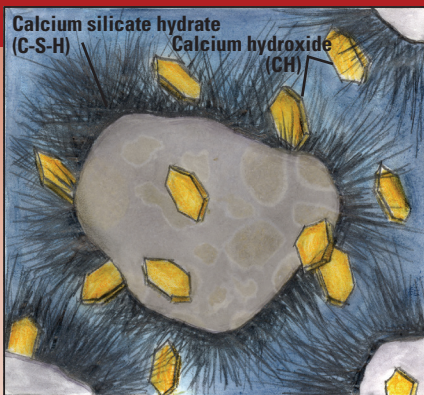

After final set, the rate of C_3S reactions begins to slow and the amount of heat generated peaks and begins to drop. This occurs because the build-up of C-S-H and CH interferes with contact between remaining water and undissolved cement grains.

During this stage, several things are occurring:

- The concrete is gaining strength, as the amount of C-S-H and CH increases. However, the concrete is still somewhat porous and should carry only light construction traffic.
- Tensile stresses may be building faster than tensile strength. At some point, stress will exceed strength, causing the concrete to crack. Unless joints are sawed to control crack location, random cracking will occur.
- Sometime after the temperature peaks, $C\bar{S}$, which has continued reacting with aluminate* (see Stages 1 and 2) will be depleted. Any remaining aluminate* now reacts with ettringite to form monosulfate, which may be associated with a brief increase in heat. Monosulfate does not significantly affect concrete properties.

Stage 5: Densification

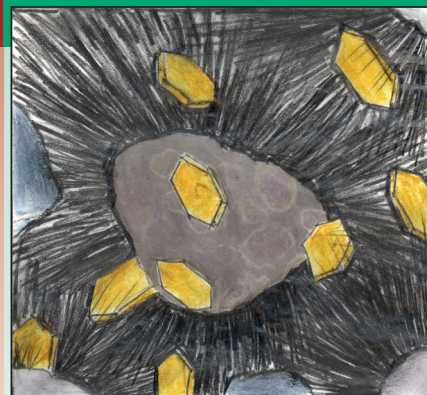

This stage is critical for continued development of concrete strength and reduction of concrete permeability. When concrete has low permeability, substances like water and dissolved salts cannot readily penetrate it and it is less susceptible to freeze-thaw damage. The concrete must be kept moist as long as possible for the following reasons:

- As long as C_3S remains and there is water in the concrete, the C_3S will continue to hydrate. As the volume of hydration products grows, concrete porosity and permeability decreases, and the concrete gains strength. Eventually, the products—particularly C-S-H—will combine into a solid mass.
- C_2S , which reacts more slowly than C_3S , also produces C-S-H. After several days, in the presence of water, most of the C_3S has reacted and the rate of C_2S hydration begins to be noticeable. It is important to maintain sufficient moisture long enough for C_2S reactions to occur.
- Hydration products will continue to develop, permeability will continue to decrease, and strength will continue to increase slowly for days, weeks, even years, as long as cementitious material and water are present. This process is affected by factors like cement type and fineness.

Can continue for years

Effects of Supplementary Cementitious Materials and Ground Limestone

SCMs, like fly ash and slag cement, are included in more than 60 percent of concrete mixtures in the US. In general, SCMs consist of the same basic elements—oxides of silicon, aluminum, and calcium—and perform basically the same function as cement. Pozzolans require a source of CH to hydrate, usually provided by hydrating portland cement. SCMs are used in concrete to achieve desired workability, strength gain, and durability.

Ground limestone is an ingredient in PLC. When limestone is interground with cement clinker, the resulting cement typically has higher Blaine fineness

because the limestone is softer than clinker and tends to be smaller particles (Tennis et al. 2011). Ground limestone contributes to a denser cement paste because the ground limestone acts as nucleation sites for hydration products, which form and occupy the water-filled space between cement grains. Carboaluminate hydration products also form, which provide minor contributions to strength (Tennis et al. 2011).

See [Supplementary Cementitious Materials in Chapter 4](#) and [Reactions of Supplementary Cementitious Materials earlier in this chapter](#).

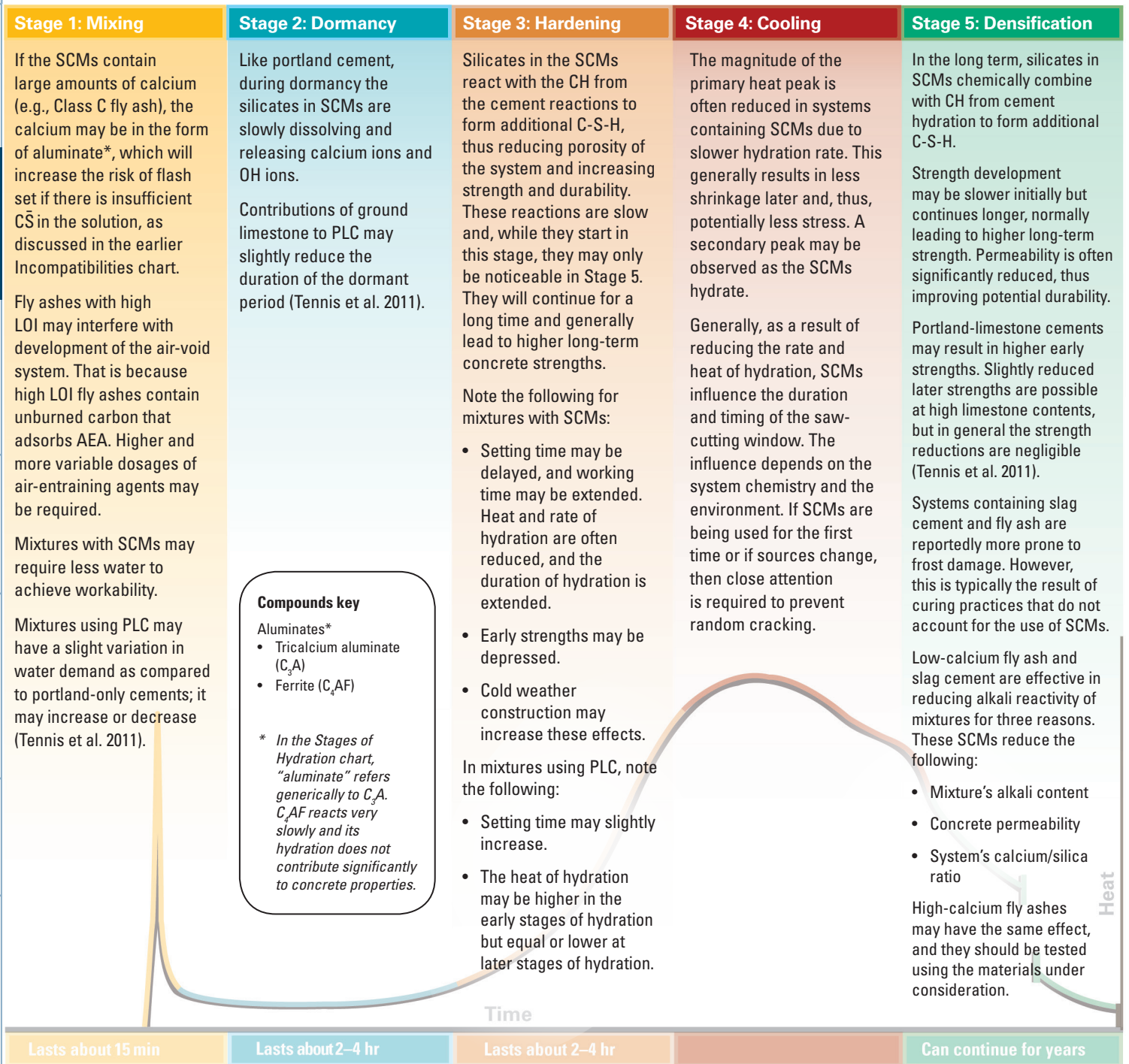

Effects of Chemical Admixtures

See Chemical Admixtures in Chapter 4.

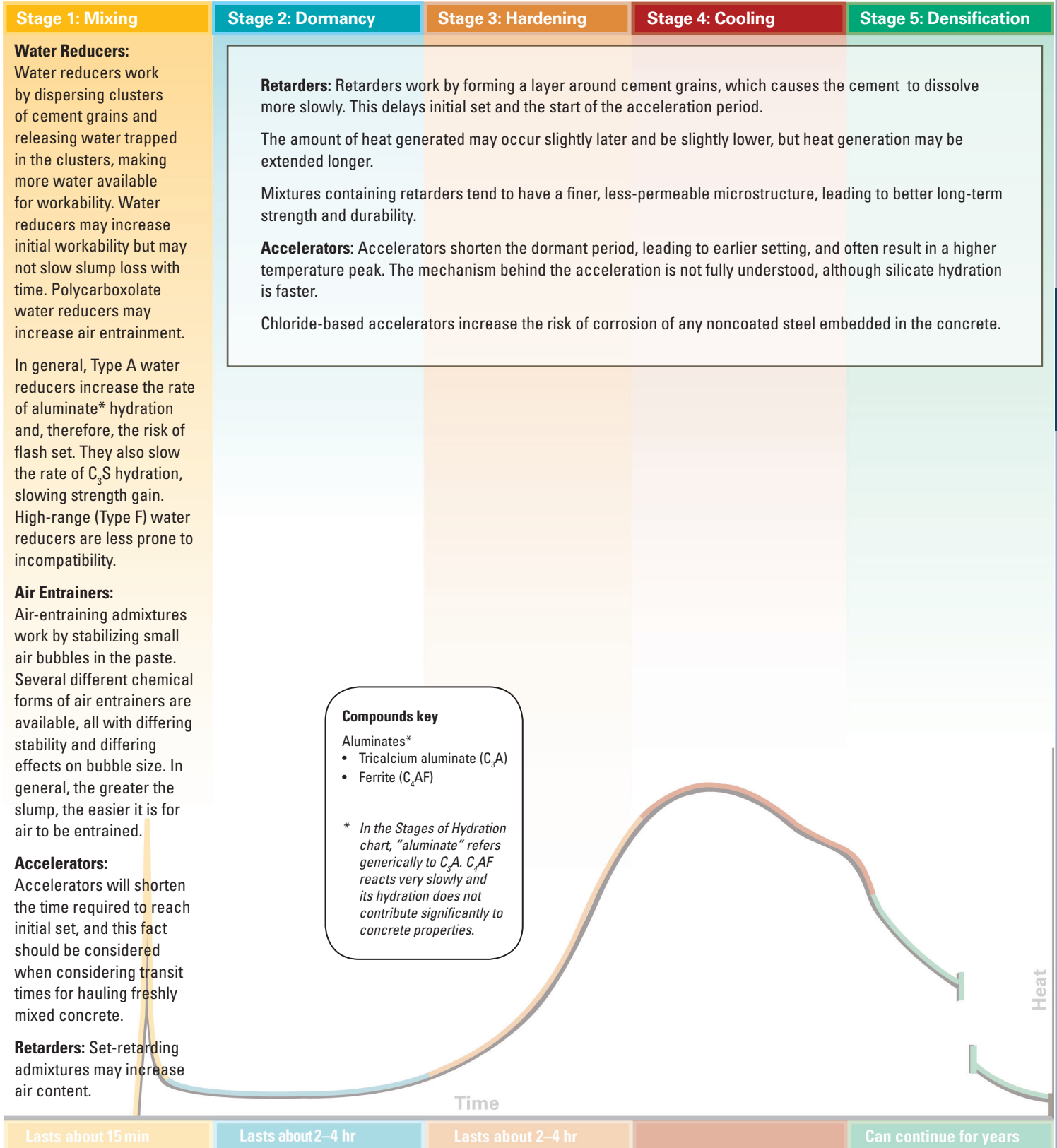

References

- AASHTO M 85 *Specification for Portland Cement*.
- AASHTO T 105 *Standard Method of Test for Chemical Analysis of Hydraulic Cement*.
- AASHTO T 131 *Standard Method of Test for Time of Setting of Hydraulic Cement by Vicat Needle*.
- AASHTO T 153 *Standard Method of Test for Fineness of Hydraulic Cement by Air Permeability Apparatus*.
- AASHTO T 185-15 *Standard Method of Test for Early Stiffening of Hydraulic Cement (Mortar Method)*.
- AASHTO T 197 *Standard Method of Test for Time of Setting of Concrete Mixtures by Penetration Resistance*.
- AASHTO TP 118 *Standard Method of Test for Characterization of the Air-Void System of Freshly Mixed Concrete by the Sequential Pressure Method*.
- ASTM C114-04a *Standard Test Methods for Chemical Analysis of Hydraulic Cement*.
- ASTM C138 *Standard Test Method for Density (Unit Weight), Yield, and Air Content (Gravimetric) of Concrete*.
- ASTM C143 *Standard Test Method for Slump of Hydraulic-Cement Concrete*.
- ASTM C150 *Standard Specification for Portland Cement*.
- ASTM C191 *Standard Test Method for Time of Setting of Hydraulic Cement by Vicat Needle*.
- ASTM C204 *Standard Test Method for Fineness of Hydraulic Cement by Air-Permeability Apparatus*.
- ASTM C231/231M *Standard Test Method for Air Content of Freshly Mixed Concrete by the Pressure Method*.
- ASTM C359 *Standard Test Method for Early Stiffening of Hydraulic Cement (Mortar Method)*.
- ASTM C403/C403M-16 *Standard Test Method for Time of Setting of Concrete Mixtures by Penetration Resistance*.
- ASTM C457 *Standard Test Method for Microscopical Determination of Parameters of the Air-Void System in Hardened Concrete*.
- ASTM C807 *Standard Test Method for Time of Setting of Hydraulic Cement Mortar by Modified Vicat Needle*.
- ASTM C1365 *Standard Test Method for Determination of the Proportion of Phases in Portland Cement and Portland-Cement Clinker Using X-Ray Powder Diffraction Analysis*.
- Cross, W., E. Duke, J. Kellar, and D. Johnston. 2000. *Investigation of Low Compressive Strengths of Concrete Paving, Precast and Structural Concrete*. South Dakota Department of Transportation, Pierre, SD.
- Dodson, V. 1990. Chapter 6: Air-Entraining Admixtures. *Concrete Admixtures*. Van Nostrand Reinhold, New York, NY. pp. 129–158.
- Johansen, V. C., P. C. Taylor, and P. D. Tennis. 2006. *Effect of Cement Characteristics on Concrete Properties*. Second Edition. Portland Cement Association, Skokie, IL.
- Kantro, D. L. 1981. Influence of Water-Reducing Admixtures on the Properties of Cement Paste: A Miniature Slump Test. Portland Cement Association, Skokie, IL.
- Kozikowski, R. L., D. B. Vollmer, P. C. Taylor, and S. H. Gebler. 2005. *Factors Affecting the Origin of Air-Void Clustering*. Portland Cement Association, Skokie, IL.
- Sutter, L. L., R. D. Hooton, and S. Schlorholtz. 2013. *NCHRP Report 749: Methods for Evaluating Fly Ash for Use in Highway Concrete*. National Cooperative Highway Research Program, Washington, DC.
- Taylor P. C., L. A. Graf, J. Z. Zemaitis, V. C. Johansen, R. L. Kozikowski, and C. F. Ferraris. 2006. *Identifying Incompatible Combinations of Concrete Materials: Volume I*. Federal Highway Administration, Turner-Fairbank Highway Research Center, McLean, VA.
- Tennis, P. D. and H. M. Jennings. 2000. A Model of Two Types of C-S-H in the Microstructure of Portland Cement Pastes. *Cement and Concrete Research*, Vol. 30, No. 6, pp. 855–863.
- Tennis, P. D., M. D. A. Thomas, and W. J. Weiss. 2011. *State-of-the-Art Report on Use of Limestone in Cements at Levels of up to 15%*. Portland Cement Association, Skokie, IL.
- Wadso, L. 2004. Unthermostated Multichannel Heat Conduction Calorimeter. *Cement, Concrete, and Aggregates*, Vol. 26, No. 2, pp. 1–7.

Chapter 6

Critical Properties of Concrete

Introduction	128
Fresh Properties	128
Mechanical Properties	142
Durability Related Properties	164
References	179

Introduction

This chapter discusses critical properties of concrete that are needed to be able to mix, transport, place, finish, and maintain high-quality pavement. Some properties, like workability and materials segregation, are manifested only when the concrete is in the fresh or plastic state before it has hardened. Others, like frost resistance, are for mature hardened concrete. Still others, like strength gain, begin early in the hydration process, remain critical during the first few days, and play a role in the performance of the concrete pavement over its service life.

Note that “durability” is not discussed as a concrete property. Instead, the various properties that contribute to potential durability—permeability, frost resistance, resistance to de-icing chemicals, sulfate resistance, alkali–silica reaction (ASR), abrasion resistance, and early-age cracking—are covered.

At times, requirements for different properties in a specific mix may be mutually exclusive, meaning that compromises may need to be made. For example, high early concrete strengths for early opening are often achieved by increasing cement content, which in turn increases shrinkage that can cause cracking. It is increasingly important for the designer, ready-mix provider, contractor, and owner to understand how their decisions affect the other parties and to communicate among themselves about their decisions. This is the basis of the need for a pavement to be treated as an integrated system, not just a series of independent activities and materials.

For each concrete property, this chapter discusses the property’s significance, factors that affect it, and tests used to measure it. (Chapter 7 discusses how the required properties can be achieved in the final concrete system. Chapter 9 discusses quality assurance (QA) and quality control (QC) testing and describes methods for a suite of specific tests.)

Fresh Properties

Uniformity of Mixture

Key Points

- The goal is to make uniform concrete, even though the materials used to make the concrete may be variable.
- Materials and the environment at the batch plant are constantly changing. Despite these changes, it is important that the mixture properties be uniform from batch to batch to prevent variations during paving and in the final pavement.
- Materials properties must be regularly monitored and proportions adjusted accordingly.
- Batching should be done by mass rather than by volume because errors introduced by aggregate bulking can be significant.
- Specifications: ASTM C94/AASHTO M 157, ASTM C172/AASHTO R 60.

Simple Definition

In uniform concrete, the concrete properties are consistent from batch to batch, even though the materials used to make the concrete may be variable.

Significance of Uniformity

Experienced personnel can make a wide range of less-than-perfect materials into a mixture that will work satisfactorily. It is, however, hard for the paver operator to accommodate changes in the mixture as it varies from batch to batch because it takes time to adjust paving equipment. When such adjustments are frequently required between batches, there is a much higher risk of unsatisfactory finishes, low strengths, cracks, and durability problems. It is therefore of great importance for paving concrete to be uniform from batch to batch.

(Chapter 9 discusses some of the implications of uniformity on quality management systems and testing.)

Factors Affecting Uniformity

All aspects of concrete production—including the variability of raw materials (specifically, the aggregates and cement), batching operations, and mixing operations—can affect the uniformity of the final product.

Raw Materials

Aggregates should be tested for gradation, density, and moisture content, and they should be stored and handled in ways that maintain uniform moisture content and minimize segregation and contamination. Preferably, cement should be from a single source and lot or at least delivered in large enough quantities for several days of work.

Batching Operations

Batching is the process of measuring concrete mix ingredients by either mass or volume and introducing them into the mixer. Most specifications require that batching be done by mass rather than by volume (ASTM C94/AASHTO M 157), with the following typical levels of accuracy (see [Batching in Chapter 9](#)):

- Cementitious materials: ± 1 percent
- Aggregates: ± 2 percent
- Total water (including that adsorbed to the aggregate): ± 1 percent
- Admixtures: ± 3 percent

Mixing Operations

Thorough mixing is required to evenly distribute all mixture constituents until the mix is uniform and entrained air bubbles are stabilized (see [Mixing Concrete in Chapter 8](#) for information about mixing time). Mixers should not be loaded above their rated capacities and should be operated at the mixing speed recommended by the manufacturer. The duration of mixing (mix cycle) is important, and it must be sufficiently long to achieve the desired mix uniformity but not too long because this can negatively impact

the entrained air-void system. Mixer blades should be routinely inspected for wear or coating with hardened concrete, both of which can detract from effective mixing. ASTM C94 provides details of requirements for mixing.

Uniformity Testing

Over the years, a variety of tests have been used to assess concrete uniformity (Table 6-1). Commonly, unit weight (see [Unit Weight test in Chapter 9](#)), air content, slump, compressive strength, and coarse aggregate content are used as indicators of concrete uniformity (Kosmatka and Wilson 2016). ASTM C94/AASHTO M 157 set out the requirements for monitoring and accepting the uniformity of concrete, and the topic is discussed in more detail [under Quality Control in Chapter 9](#).

The need for representative samples is critical for assessing concrete uniformity. Samples should be obtained in accordance with ASTM C172/AASHTO R 60.

Table 6-1. Requirements for uniformity of concrete

Test	Maximum Permissible Difference
Air-free density (unit weight)	1.0 lb/ft ³
Air content	1.0%
Slump	
If average slump is less than 4 in.	1.0 in.
If average slump is 4 to 6 in.	1.5 in.
Coarse aggregate content	6.0%
Average compressive strength at 7 days for each sample*	7.5%*

* Approval of the mixture shall be tentative, pending results of the 7-day compressive strength tests

Source: ASTM C94/C94M-18

Workability

Key Points

- Workability is an indication of the ease with which concrete can be transported, placed, compacted, and finished.
- Changes in workability indicate that the raw materials, proportions, or environment are changing.
- Good workability not only benefits fresh concrete, but it indirectly impacts the properties of the hardened concrete.
- Fresh concrete characteristics that affect workability include consistency, mobility, pumpability, compactability, and finishability.
- Concrete should have the right workability for the equipment being used to place it.
- Water should not be added to concrete on-site unless this can be done without exceeding the water/cementitious materials (w/cm) ratio of the mix design and meeting all other requirements for water addition as stipulated in ASTM C94.
- Workability assessment for slipform paving should include how the mixture responds to vibration, balanced with the need to minimize the risk of edge slump.
- Testing methods:
 - Slump: ASTM C143/AASHTO T 119
 - Box and vibrating Kelly (VKelly): AASHTO PP 84, AASHTO TP 129

Simple Definition

As given in *ACI Concrete Terminology* (ACI CT-18), workability is defined as “that property of freshly mixed concrete or mortar that determines the ease with which it can be mixed, placed, consolidated, and finished to a homogenous condition.”

Significance of Workability

Workability is of primary concern to the contractor because it affects the amount of effort required to transport, consolidate, and finish the concrete (Scanlon 1994). Ideally, a concrete pavement mixture should flow readily under vibration and be static when

vibration ceases. Experience has shown that the effort imposed to place mixtures with poor workability may have negative effects, such as the loss of entrained air near the vibrators. Although the choice of workability limits should be made by the contractor to suit their equipment, the agency should reserve the right to confirm that a suitable mixture is planned and in use.

The benefits of good workability are often associated only with fresh concrete, in terms of the amount of mechanical work required to place and consolidate the concrete without segregation. Workable mixtures that allow adequate consolidation greatly reduce the presence of large voids in the concrete, which can reduce concrete strength (Neville 1996). Poor workability can affect smoothness and make finishing difficult, causing tearing of the surface that can lead to cracking. A slipform paving mixture with poor workability may be prone to edge slumping.

Workability can also provide a useful measure of uniformity because variability in workability between loads is likely due to changes in mixture water, air content, and/or other constituents, which could impact long-term performance.

Factors Affecting Workability

In general, workability can be controlled through the proper proportioning of the constituent materials. However, workability depends on several factors, including the physical and chemical properties of the individual components.

Do Not Add Water to Improve Workability

When paving crews experience problems with workability, they are often tempted to add water to the mix. However, water should not be added to concrete on-site unless it can be done in strict compliance with ASTM C94, which stipulates that only a one-time addition of water is permitted prior to discharging any concrete and that the w/cm ratio of the approved mix design cannot be exceeded. (For a discussion of the w/cm ratio, [see Step 2 under the Absolute Volume Method in Chapter 7.](#)) The late addition of water or adding excess water will always lead to other problems, which may include reduced strength and increased permeability.

Water Content

The primary factor affecting the workability of a concrete mix is the water content. Increasing the water content will increase the flow and compactability of the mix, but it can also reduce strength while increasing segregation, bleeding, and permeability (Kosmatka and Wilson 2016). A minimum amount of water is required in a mixture to achieve a base workability, which can then be enhanced by the addition of chemical admixtures, most notably water reducers (Taylor 2012).

Aggregates

Several factors related to the aggregates in a mix have a significant effect on workability. The first is the amount of aggregate; increases in the aggregate-cement ratio result in a decrease in workability for a fixed w/cm ratio (Kosmatka and Wilson 2016, Taylor 2012).

Aggregate grading is critical. A deficiency of fine aggregate can lead to a harsh mixture that is difficult to work; whereas, an excess of very fine material will make the mix sticky (Scanlon 1994). A more uniform grading of aggregate particles may improve workability by filling the voids between larger particles and reducing the amount of locking between particles (see Aggregate

Gradation in Chapter 4). Work has shown that aggregate gradations within the so-called Tarantula curve are more likely to provide desirable workability with a lower paste content than the same materials used at different combinations (Figure 6-1, see VKelly [Response to Vibration] in Chapter 9) (Cook et al. 2013).

Finally, the properties of the aggregate itself, including particle shape and porosity, are important. More spherical particles generally produce more workable mixtures than elongated or angular ones, while more absorptive, dry aggregates may reduce workability by removing water from the paste.

Entrained Air

Entrained air increases the paste volume while acting as a lubricant to improve the workability of concrete. Entrained air is particularly effective in improving the workability of lean (low cement content) mixtures that otherwise might be harsh and difficult to work and of mixtures with angular and poorly graded aggregates (Kosmatka and Wilson 2016). However, excessive amounts of entrained air can make a mixture sticky and difficult to finish and will reduce concrete strength.

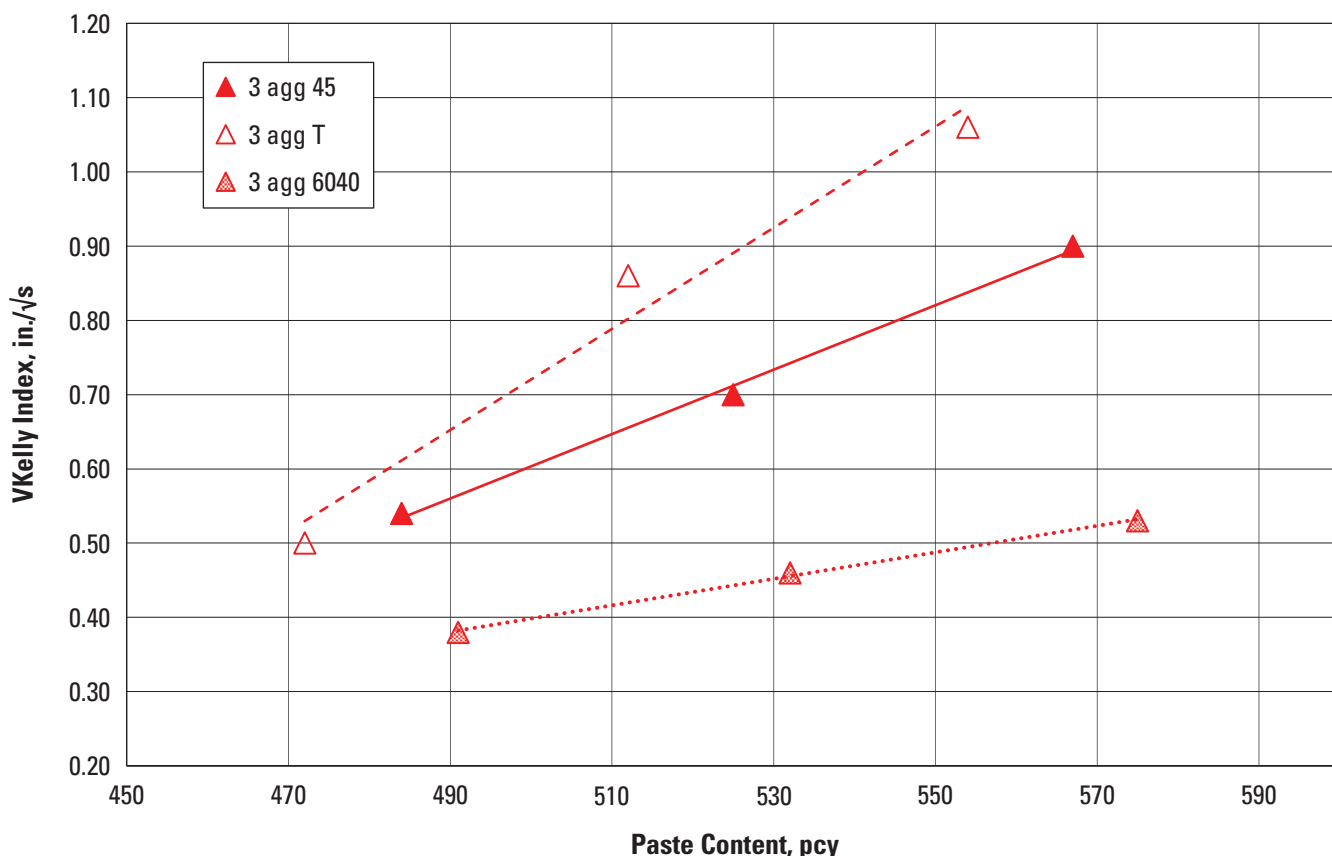

Figure 6-1. Effect of aggregate gradation on workability as a function of paste content

Time and Temperature

Workability decreases with time as water from the mixture evaporates, is absorbed by the aggregate, and reacts with cement during the initial chemical reactions (Wong et al. 2000). Increases in ambient temperatures will accelerate these effects because higher temperatures increase both the evaporation and hydration rates (Mindess and Young 1981).

Cement

The characteristics of the cement may also affect workability. For example, the increased cement fineness (therefore, the increased specific surface area) of Type III cements means they will reduce workability at a given w/cm ratio compared to a Type I cement (Mindess and Young 1981). Interground limestone may slightly affect the water demand of a mixture both up or down, depending on the characteristics of the system as a whole (Tennis 2011).

Supplementary Cementitious Materials

Fly ash (AASHTO M 295/ASTM C618) and ground granulated blast furnace (GGBF) slag have generally been found to improve concrete workability because of the fine spherical nature of fly ash and the glassy surface of GGBF slag particles. In hot weather, some fly ashes may cause early stiffening and loss of workability of the mixture (see *Stiffening and Setting in Chapter 7*).

Silica fume will markedly increase the water demand and stickiness at dosages above five percent by mass of cement because of the high surface area. Less than five percent silica fume may improve workability because the silica fume particles tend to be spherical and assist with separating cement grains. (Silica fume is not typically used in concrete for pavements; see *Supplementary Cementitious Materials in Chapter 4*.)

Admixtures

Water-reducing admixtures are used to increase workability, although the rate of slump loss may not be reduced, depending on the chemistry of the admixture (Kosmatka and Wilson 2016). Set-retarding admixtures reduce the early rate of hardening and permit concrete to be handled and vibrated for a longer period of time.

Workability Testing

Several characteristics of fresh concrete are related to workability. Some of these characteristics include the following (Mindess and Young 1981, Scanlon 1994):

- Consistency or fluidity
- Response to vibration
- Mobility
- Pumpability
- Compactability
- Finishability
- Harshness

The measurement of workability is often determined by judgment and engineering experience (Daniel 2006). The study of rheology has sought to better describe workability of concrete by measuring yield stress, viscosity, and thixotropy. However, this is of limited application in low-slump mixtures required for slipform paving. Newer tests (VKelly and Box) are being evaluated that do indicate how a mixture responds to vibration, as discussed later.

The following sections summarize common tests for measuring workability, with more detailed information provided by Mindess et al. (2003), Daniel (2006), Neville (1996), Wong et al. (2000), and Kosmatka and Wilson (2016). (See also *Chapter 9*.)

Slump Test

The slump test (ASTM C143/AASHTO T 119) measures the consistency of the mix, i.e., the ability of fresh concrete to flow. During flow, two events take place—one starts the movement and the other continues the movement. The slump test is an indicator of the former.

The slump test is valid for a range of results from 0.5 to 9 in. using coarse aggregate less than 1.5 in. The slump test measures concrete slump under the self-weight of the concrete only, and as such does not reflect the behavior and workability of the mixture under dynamic conditions like vibration or finishing (Neville 1996).

With different aggregates or mix properties, the same slump can be measured for concrete mixtures that exhibit very different workability. Nevertheless, the slump test is useful as a QC measure, with significant changes in the slump on a given job indicating that changes have occurred in the characteristics of materials, mixture proportions, water content, mixing, time of test, or the testing itself (Kosmatka and Wilson 2016).

VKelly Test

The VKelly test is based on the Kelly ball (AASHTO TP 129), except a vibrator has been attached to the ball. The rate at which the ball sinks with a $\frac{3}{4}$ in. head vibrating at 8,000 vpm is recorded for 36 seconds and plotted on a root time scale. The slope of the line (Figure 6-2) is reported as the VKelly index. Experience to date has indicated that the VKelly index for slipform paving mixtures should be in the range of 0.6 to 1.1 in./ \sqrt{s} . The test is sensitive to aggregate gradation and to paste content of mixtures. It is intended to be used primarily during laboratory mixture proportioning and prequalification work to assure users that the concrete will perform as desired in a paving machine.

Box Test

The Box test (Cook et al. 2013) comprises a 12 in. cubic wooden box that is filled to a height of 9.5 in. with fresh concrete. A 1 in. vibrator running at 12,000 vpm is inserted and removed vertically in the center at a constant rate over 6 seconds. The forms are immediately

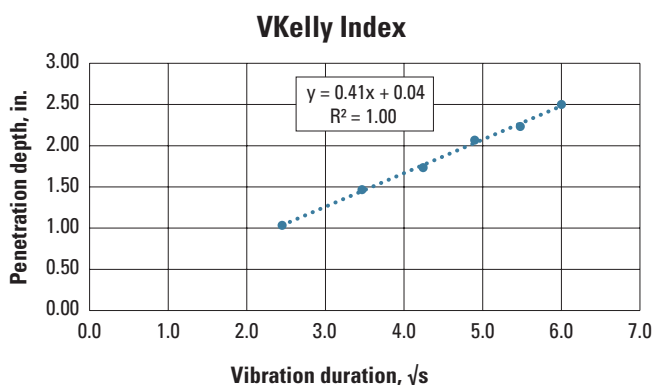

Figure 6-2. VKelly index is the slope of the plot of penetration depth versus root time

removed and the concrete is inspected for signs of edge slump (more than $\frac{1}{4}$ in. deformation on edges is considered unacceptable) and degree of consolidation on each side as indexed against a template (Figure 6-3).

As is true for the VKelly test, the Box test is intended to be used primarily during laboratory mixture proportioning and prequalification work to assure users that the concrete will perform as desired in a paving machine. This test has not yet been standardized.

Vebe Test

The Vebe test was developed in the 1940s and is particularly suitable for determining differences in the consistency of very dry mixes (Mindess and Young 1981). In this test, a sample of concrete is molded with the slump cone inside a larger cylinder. The slump mold is removed, a transparent disk is placed on top of the concrete, and the sample is then vibrated at a controlled frequency and amplitude until the lower surface of the disk is completely covered with grout (Mindess and Young 1981). The time in seconds for the disk to become covered is the Vebe time, and it can range from 5 to 30 seconds.

Although there is no ASTM standard for this test, there is a European standard test that is widely used throughout Europe (EN 12350-3).



Cook et al. 2013, Oklahoma Transportation Center

Figure 6-3. Box test sample after the forms are removed

Compacting Factor Test

The compacting factor test is used to measure the compactability of concrete mixtures for a given amount of work. The test involves dropping fresh concrete through multiple heights and measuring the degree to which it compacts (Wong et al. 2000).

The degree of compaction, called the compacting factor, is expressed in terms of the ratio of the density actually achieved in the test to the density of the same concrete fully compacted (Neville 1996). The test is more sensitive at the low-workability end of the scale and is most appropriate for mixtures with a maximum aggregate size less than 1.5 in. (The test is standardized in Europe as EN 12350-4.)

Segregation of Concrete Materials

Key Points

- Segregation of coarse aggregate from the mortar results in concrete with lower strength and poor durability.
- The primary way to prevent segregation is to use well-graded aggregate.
- If coarse aggregates advance in front of or behind the fine particles and mortar when the concrete is being placed, the mixture is segregating.

Simple Definition

Segregation is the tendency for coarse aggregate to separate from the mortar in a concrete mixture, particularly when the mixture is being transported or consolidated.

Significance of Segregation

Segregation results in part of the batch having too little coarse aggregate and the remainder having too much. The former is likely to shrink more, crack, and have poor resistance to abrasion; whereas, the latter may be too harsh for full consolidation and finishing. The result is that the concrete mixture is not homogenous, making it difficult to place and finish (Figure 6-4).



Jim Grove, ATI Inc./FHWA, used with permission

Figure 6-4. Segregated concrete example

Segregation is especially harmful in placing concrete for pavement because it results in problems such as strength loss, edge slump, spalling, isolated cracking, blistering, and scaling.

Factors Affecting Segregation

Segregation is primarily prevented by using a well-graded aggregate system because a gap-graded aggregate system is more likely to segregate.

Segregation tends to decrease, to a point, with increasing amounts of fine materials, including cement and supplementary cementitious materials (SCMs), in the system. At the other extreme, poor mixture proportioning with excessive paste can also lead to segregation.

Segregation Testing

Many specifications require that segregation be prevented, although there is no standard test to measure it. However, segregation is readily visible and can be recognized easily when the concrete is being discharged from a chute or a pump. If the coarse particles advance in front of or behind the fine particles and mortar, the mixture is segregating. The concrete plant should then be contacted to adjust the mix proportions.

Bleeding

Key Points

- Bleeding is the appearance of water at the surface of newly placed, plastic concrete due to settlement of the heavier particles.
- Some bleeding helps avoid plastic cracking in the surface, which can occur when water evaporating from the surface causes the surface to dry quickly.
- Excessive bleeding can result in voids under large aggregate particles and the formation of channels through the concrete. Excessive bleeding will also increase the effective w/cm ratio at the surface and weaken the surface.
- Ideally, finishing and curing should occur when bleeding has finished and bleed water has evaporated.
- Bleeding is reduced with increasing fines content and with air-entraining and/or water-reducing admixtures.
- Specifications: ASTM C232/AASHTO T 158.

Simple Definition

Bleeding is the appearance of a layer of water at the top or the surface of freshly placed concrete after it has been consolidated and struck off but before it has set. Bleeding may also be referred to as water gain, weeping, or sweating.

Significance of Bleeding

Bleeding is caused by the settlement of solid particles (cement and aggregate) in the mixture and the simultaneous upward migration of water (Kosmatka and Wilson 2016) (Figure 6-5). A small amount of bleeding is normal and expected in freshly placed concrete. In fact, some bleeding is actually helpful in controlling the development of plastic shrinkage cracking. If the rate of moisture evaporation at the surface exceeds the bleeding rate (Kosmatka 2006, Poole 2005), the surface will dry and crack. A lack of bleed water can also lead to a dry surface that can be very difficult to finish (Kosmatka 2006).

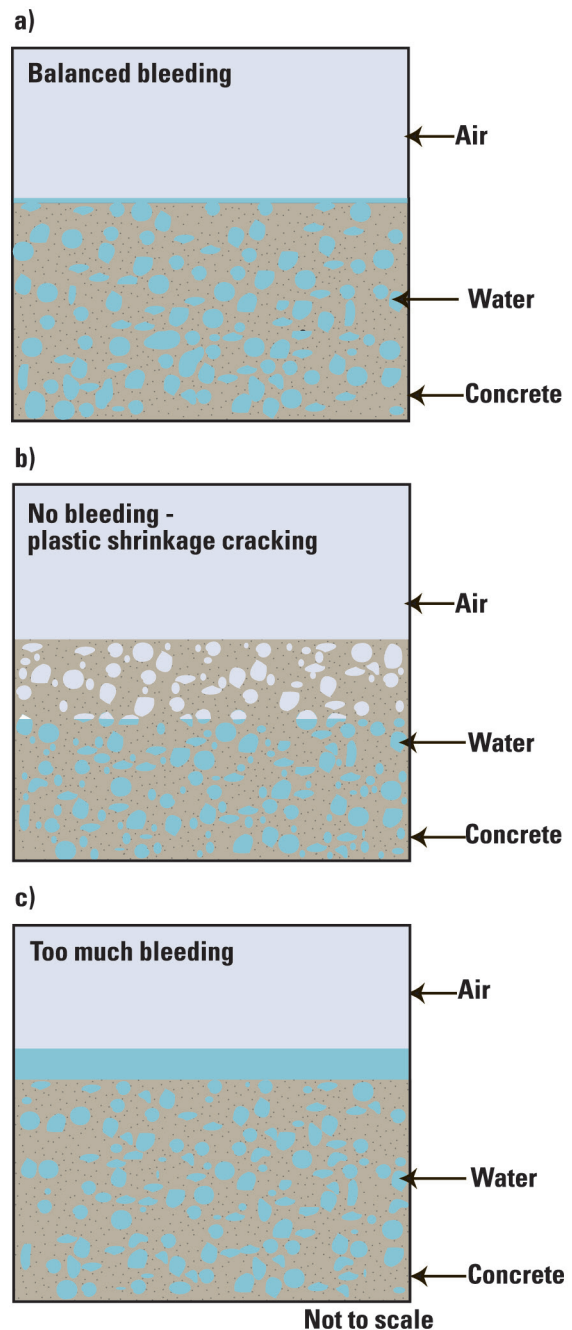

Celik Ozyildirim

Figure 6-5. Bleeding

However, excessive bleeding reduces concrete strength and durability near the surface. The rising water can carry with it a considerable amount of fine cement particles, forming a layer of weak and nondurable material, called laitance, at the surface (Neville 1996).

Excessive bleeding also may delay the finishing process, which in general should not proceed until the bleed water has evaporated from the surface (Kosmatka 2006). If the surface is finished with bleed water present, a thin and weak layer is created on the surface that is susceptible to scaling and delamination. In some cases, if the fresh concrete surface is prematurely sealed by troweling while the underlying concrete is still releasing bleed water, blisters (small hollow bumps beneath the concrete surface) can form.

Bleed water can also accumulate within the concrete mix itself, under large aggregate particles or reinforcing bars (Mindess et al. 2003). The former results in reduced concrete strength (due to decreased aggregate-paste bond). The latter may reduce the paste-steel bond, possibly promoting the corrosion of steel because the steel is not in contact with the corrosion-resistive paste (Kosmatka 2006).

Factors Affecting Bleeding

The initial bleeding process generally begins after agitation of the concrete mix ends, and bleeding continues until the cement paste has stiffened sufficiently to resist the settlement of the solid particles (Neville 1996). The duration of bleeding depends on the thickness of the concrete section as well as the setting properties of the cementitious materials, with thinner sections or faster-setting concretes exhibiting less bleeding (Kosmatka 2006). Any increase in the amount of water or in the w/cm ratio results in more water available for bleeding (Kosmatka 2006).

Cement

As the fineness of cement increases, the amount of bleeding decreases, possibly because finer particles hydrate earlier and also because their rate of sedimentation (settlement) is lower (Neville 1996). Increasing cement content also reduces bleeding (Kosmatka 2006). Cement with a high alkali content or a high calcium aluminate (C₃A) content will exhibit less bleeding (Neville 1996).

Supplementary Cementitious Materials

Concrete containing fly ash generally exhibits a lower bleeding rate; however, due to retarded setting, the total bleed volume may be similar or greater than portland cement-only concrete. Ground granulated blast furnace slags have little effect on bleeding rates (Wainwright and Rey 2000). Silica fume can greatly reduce, or often stop, bleeding, largely because of the extreme fineness of the particles (Neville 1996).

Aggregate

The influence of aggregate gradation on bleeding is primarily observed with changes to the amount of fine material. Concrete mixtures containing aggregates with a high amount of silt, clay, or other material passing the #200 sieve can significantly reduce bleeding (Kosmatka 2006); whereas, a lack of fine materials will increase bleeding.

Chemical Admixtures

Air-entraining agents have been shown to significantly reduce bleeding in concrete, largely because the air bubbles appear to keep the solid particles in suspension (Neville 1996). Water reducers also reduce the amount of bleeding because they release trapped water in a mixture.

Testing for Bleeding

When required, ASTM C232/AASHTO T 158 include two test methods for assessing bleeding. The first test method involves hand consolidating a sample of concrete by rodding in a container of standard dimensions and then covering the sample and leaving it undisturbed. The bleed water is drawn off the surface every 10 minutes during the first 40 minutes and every 30 minutes thereafter until bleeding stops. The total bleeding and the rate of bleeding may then be determined.

The second test method in ASTM C232 uses a sample of fresh concrete consolidated by vibration and, after covering the sample, intermittently vibrating it for a period of one hour to determine the total volume of bleed water.

Key Points

- Setting is when concrete loses its workability and becomes hard; it is influenced by the w/cm ratio and chemistry of the cementitious system.
- Class F fly ash and GGBF slag will generally retard setting time.
- Setting is accelerated when the concrete temperature increases.
- Set-accelerating and retarding chemical admixtures in the mixture can control set time.
- Setting affects the time available for placing and finishing, as well as the sawing window when joints can be sawed.
- Testing specifications: ASTM C191/AASHTO T 131, ASTM C266/AASHTO T 154, ASTM C451/AASHTO T 186, ASTM C403/AASHTO T 197.

Simple Definition

Setting is the stage when concrete changes from plastic to solid.

Significance of Setting

Over time, the chemical reactions of portland cement and water form hydration products that connect and intertwine, leading to stiffening, setting, and hardening—a continuous process. The time when setting occurs is important because it influences the time available to place and finish the concrete. The saw-cutting window is also indirectly related to setting. Variation in setting times between batches may indicate issues with materials compatibility.

Typically, initial set occurs between two and four hours after batching; final set occurs between four and eight hours after batching. Initial set and final set are arbitrarily determined based on the test methods available, but initial set generally occurs shortly after initiation of the silicate phase of cement hydration (see [Portland Cement Hydration in Chapter 5](#).)

A correlation has been observed between initial set and the start of the sawing window, making it easier to predict when sawing should begin (Wang 2016).

False set and flash set are the stiffening of the mixture in the first few minutes after mixing and are due to uncontrolled aluminate/sulfate reactions (see [Potential Materials Incompatibilities in Chapter 5](#)). False set is temporary and can be worked through with continued mixing; flash set is permanent, meaning that the mixture will have to be discarded.

Factors Affecting Setting

A number of factors affect concrete setting time.

Temperature/Weather

Increasing temperature reduces set time. Decreasing temperature increases set time. Hydration will stop when the temperature is close to 32°F. Exposure to sunlight and/or windy conditions also influences setting, especially at the surface, largely due to the effects of heating and evaporative cooling.

Water/Cementitious Materials Ratio

A lower w/cm ratio reduces set time.

Cement Type

Cement chemistry will strongly influence set time (see [Reactions of Supplementary Cementitious Materials and Potential Materials Incompatibilities in Chapter 5](#)). The fineness of the cement will also impact set time, with finer cements setting more quickly.

Chemical Admixtures

Accelerating and retarding admixtures are used deliberately to control the setting time (Kosmatka and Wilson 2016). Overdosing some water reducers may result in set retardation (see [Potential Materials Incompatibilities in Chapter 5](#)).

Timing of Addition of Admixtures

Delayed addition of some water reducers may prevent early stiffening or retardation.

Mixing

Improved mixing influences hydration by improving the homogeneity and dispersion of the cementitious materials and, thus, accelerates setting.

Supplementary Cementitious Materials

Class F fly ash and slag cement will generally retard the setting time of concrete. Class C fly ash may accelerate or retard setting, depending on the chemistry of the fly ash and the other components in the system.

Testing for Setting Time

Setting time is a characteristic both of cement (tested as a standard paste) and of concrete (tested as a mortar extracted from the concrete).

Cement specifications typically place limits on setting time using the Vicat apparatus (ASTM C191/AASHTO T 131). This test is run on paste made to a standard consistency and measures the time at which different indicators penetrate the surface.

Cements are tested for early stiffening (flash set/false set) using ASTM C451/AASHTO T 186 (paste method) and ASTM C359/AASHTO T 185 (mortar method), which use the penetration techniques of the Vicat apparatus. The test records the depth of penetration after remixing at fixed intervals.

Concrete setting is determined using ASTM C403/AASHTO T 197. Mortar is separated from the concrete through a #4 sieve, and the penetration resistance is recorded as a function of time. The initial and final setting times are defined as the time the mortar achieves a penetration resistance of 500 lb/in² and 4,000 lb/in², respectively (Figure 6-6).

An alternative approach for measuring setting time is to observe the change in the speed of sound through a fresh concrete sample, which accelerates when solid hydration products start to percolate through the sample (Figure 6-7). This can be measured using commercially available devices (Wang et al. 2016). This test can be conducted in the field, thus assessing the effects of the ambient temperature on the concrete as placed.

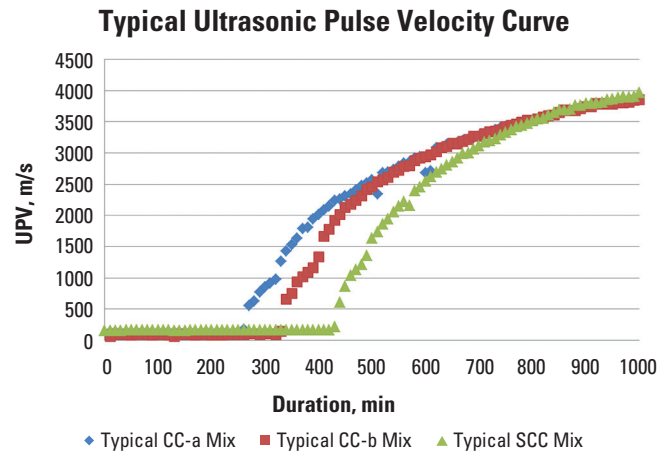

Figure 6-7. Ultrasonic velocity accelerates when mixture begins to set

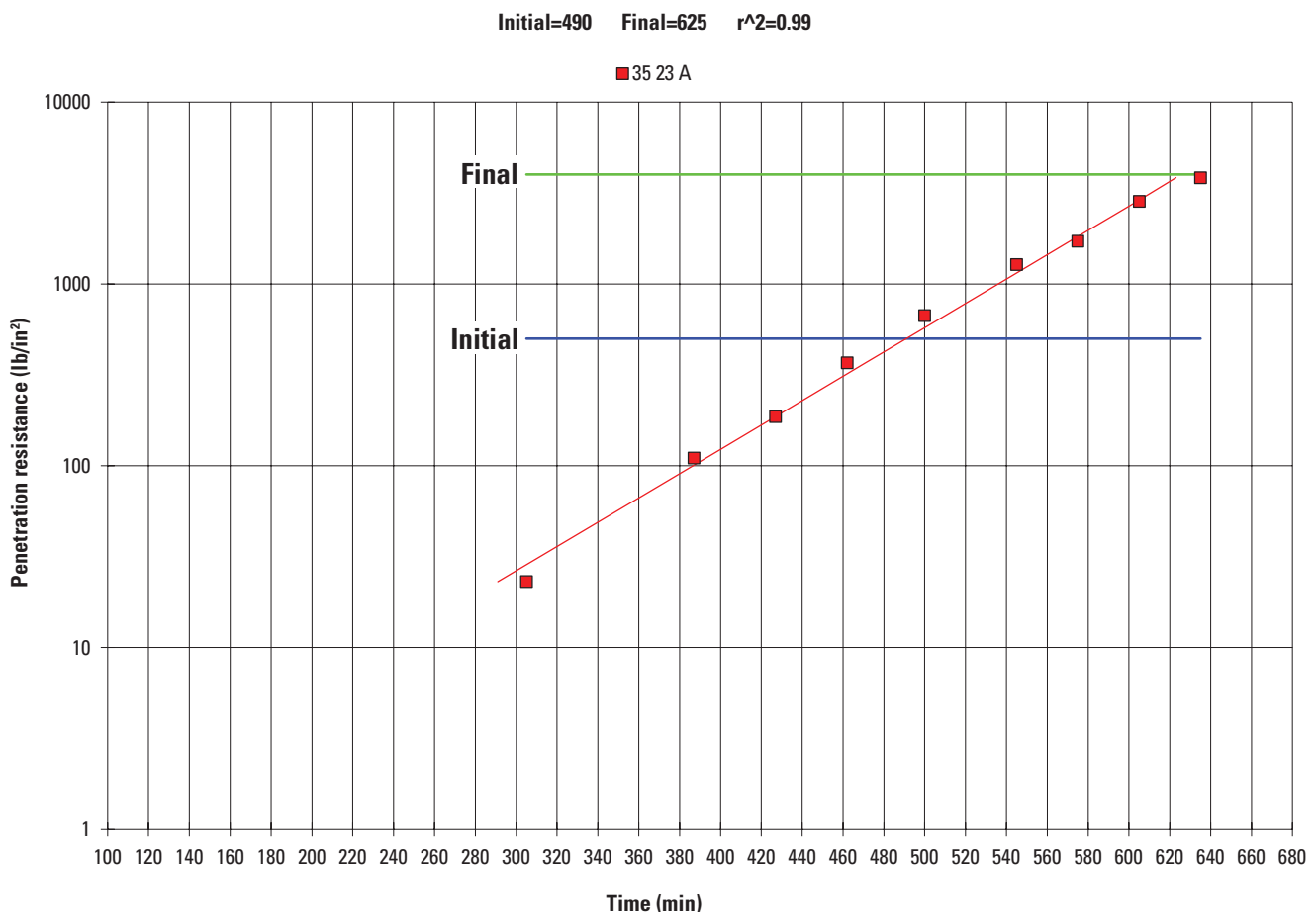

Figure 6-6. Plot of penetration resistance over time to determine setting time

Another approach is to use a semi-adiabatic calorimeter to observe the temperature rise due to exothermic hydration. Initial set is defined as the time when the temperature has risen 20 percent of the total rise of the sample.

Temperature Effects

Key Points

- Concrete hydration generates heat.
- The risk of cracking is increased with increasing placement temperature.
- Concrete expands with increasing temperature and contracts (shrinks) with decreasing temperature. The amount of this expansion and contraction is governed primarily by the aggregate type (see [Aggregates in Chapter 4](#)).
- The rate of hydration of cementitious materials is accelerated with increasing temperature and with increasing cement fineness. This will accelerate setting time and reduce the sawing window.
- Supplementary cementitious materials typically have lower heat of hydration.
- In cold-weather concreting, the challenge is to maintain the concrete temperature to prevent freezing while maintaining hydration to support strength gain.
- Testing specifications: ASTM C186, ASTM C1064/AASHTO T 309, AASHTO T 336.

Simple Definition

The reaction of cement with water (hydration) in concrete mixtures generates heat (see [the time-heat curve in Figure 5-2 in the hydration chapter \[Chapter 5\]](#)). Monitoring the temperature over time is a useful means of estimating the degree of hydration of the system. In turn, the temperature of the concrete will influence the rate of hydration (strength development) and the risk of cracking.

Significance of Thermal Properties

An optimal temperature for freshly placed concrete is in the range of 50°F to 60°F, and it should not exceed 85°F to 90°F at time of placement (Mindess et al. 2003). Problems associated with high concrete temperatures include increased water demand to maintain workability,

decreased setting time, increased danger of plastic shrinkage cracking, increased difficulty of entraining air, increased risk of incompatibility (see [Potential Materials Incompatibilities in Chapter 5](#)), and lower ultimate strength. During the winter, the primary danger is that low temperatures may slow hydration, and thus strength gain. In extreme cases, the pore solution in fresh concrete may freeze, causing permanent damage (Mindess et al. 2003).

Other thermal effects that may be of interest include solar reflectance, specific heat, and thermal diffusivity. These properties affect the amount of solar energy absorbed by concrete, the corresponding temperature change of the concrete, and the rapidity with which the concrete dissipates this temperature to its surroundings.

Effects on Hydration

The rate of hydration of concrete is significantly accelerated with increasing temperatures affecting placement and consolidation due to early stiffening, as well as accelerating the timing of saw cutting. The early strength of a concrete mixture (f'_{cr}) will be higher with an elevated temperature, but the strength may be lower at later ages than the same mix kept at a lower temperature. All chemical reactions are faster at higher temperatures, doubling for every 18°F increase; therefore, setting times will be reduced as the temperature of the concrete rises. With increasing temperature, the potential for an imbalance in the cementitious paste system will be exacerbated, possibly leading to problems with early stiffening of the mixture before the mixture can be consolidated and finished. It has been observed that water may be added to such a mix to restore workability, but with the effect of reducing strength and durability. Water added to the mix on-site should be in accordance with ASTM C94, including the provision that no water shall be added that results in exceeding the maximum water/cement ratio.

Effects on Cracking

Concrete expands as temperature rises and contracts as temperature falls. These movements can contribute significantly to the risk of cracking in concrete, particularly within the first 24 hours. If the concrete sets during the heat of the day when it is hot and expanded, it will contract significantly as it cools later that night, thus significantly increasing the risk of cracking. This can also occur when a cold front passes over concrete placed in the middle of a hot day because the risk of cracking is greater due to the sudden large drop in temperature (see [Early-Age Cracking later in this chapter](#)).

Factors Affecting Thermal Properties

Primary factors that affect a concrete pavement’s thermal properties are discussed below.

Heat of Hydration of Cementitious Materials

Type III cements, which are typically used in applications when high early strength is a goal, generate more heat and at a faster rate than Type I cements. Table 6-2 shows the typical ranges of chemical phases in cement and the heat evolution associated with these phases. This table is useful in predicting the relative heat generation of similar cements.

Cement fineness affects the rate of heat generation. Finer cements (smaller particle sizes) hydrate faster and generate heat at a faster rate. The total heat evolution is not affected by the fineness, but the peak temperature of the concrete may be higher because the heat is evolved more quickly.

Pozzolans also generate heat during hydration, but generally less than portland cement. The benefit of a lower heat of hydration is to reduce thermal shrinkage and the possibility of resultant cracking. When blended with cement, Class F fly ash has a heat of hydration that is typically 50 percent of cement. Class C fly ash generally has a heat of hydration in the range of 70 to 90 percent of that of cement. The heat of hydration of both silica fume and metakaolin are approximately 125 percent of cement. The heat of hydration of grade 100 slag cement is typically 80 percent of portland cement.

Initial Temperature

As mentioned previously, multiple strategies can be employed during construction to reduce the initial temperature. A common practice is to conduct paving only at night and/or to use pre-cooled materials in the batch. Pre-cooling can be achieved by shading and wetting the aggregates, but the use of chilled water or ice in the mixture is highly effective.

Environmental Factors

The rate of heat loss to the environment is influenced by the thickness of the concrete, the temperature of the environment, and the degree of insulation provided by the materials surrounding the concrete.

In cold-weather concreting, the challenge is to maintain the concrete temperature to prevent freezing while maintaining hydration to support strength gain. Strategies that may be employed include heating one or more of the materials, warming the jobsite environment, and/or covering the slab with insulation to hold in the heat produced as the cement hydrates.

A white pigmented curing compound should always be applied immediately after final finishing while the surface is still damp to alleviate evaporation and reduce heat build-up from solar radiation (Kosmatka and Wilson 2016).

Table 6-2. Chemical composition and heat evolution of typical portland cements

Cement type		Potential phase composition*, %				Blaine fineness, m ² /kg
		C ₃ S (%)	C ₂ S (%)	C ₃ A (%)	C ₄ AF (%)	
Type I	Range	45–65	6–21	6–12	6–11	333–431
	Mean	57	15	9	8	384
Type II	Range	48–68	8–25	4–8	8–13	305–461
	Mean	56	17	7	10	377
Type III	Range	48–66	8–27	2–12	4–13	387–711
	Mean	56	16	8	9	556
Type V	Range	47–64	12–27	0–5	10–18	312–541
	Mean	58	18	4	12	389
Heat evolution**, kJ/kg		a	b	c	d	
(kilojoules/kg)	3 d	243	50	887	289	
	7 d	222	42	1556	494	
	13 yr	510	247	1356	427	

* Source: Tennis and Bhatti (2006)

** Cement paste with water/cement ratio 0.4 at 70°F
Values represent coefficients in the equation:
Heat evolution (kJ/kg) = a(C₃S) + b(C₂S) + c(C₃A) + d(C₄AF) (Taylor 1997)

Thermal Expansion/Contraction

Thermal expansion and contraction of concrete (that is, expansion and contraction related to temperature change) vary with factors such as aggregate type, cement content, w/cm ratio, temperature range, concrete age, and relative humidity. Of these, aggregate type has the greatest influence because aggregates account for about 60 to 75 percent of concrete by volume.

A material's coefficient of thermal expansion (CTE) is a measure of how much it changes in length (or volume) for a given change in temperature. For most materials, an increase in temperature will result in lengthening (expansion) and a decrease will result in shortening (contraction). Because aggregates make up a majority of a concrete's volume, the CTE of the aggregate particles will dominate the CTE for a concrete. [Table 4-10 in Chapter 4](#), shows some typical values of the linear CTE of several aggregates, as well as those for concrete and other concrete ingredients. Typically, pure carbonate limestone aggregates have lower coefficients than siliceous aggregates, and concretes made with them have lower values. CTE values are considered in design calculations for pavements and are used in durability modeling of concretes.

The standard for measuring the CTE of concrete is AASHTO T 336. An average value for the CTE of concrete is about $5.5 \times 10^{-6}/^{\circ}\text{F}$, although values ranging from 3.2 to $7.0 \times 10^{-6}/^{\circ}\text{F}$ have been observed. In practical terms, this amounts to a length change of about $\frac{2}{3}$ in. for 100 ft of concrete subjected to a rise or fall of 90°F . Temperature changes may be caused by environmental conditions or by the heat of hydration.

Testing for Thermal Properties

If specific information is needed about the actual heat of hydration of the cementitious materials, the heat of hydration should be measured. Testing should be conducted using the proportions that will be used in the concrete mix, rather than using the individual components.

The heat of hydration can be measured in accordance with ASTM C186 or in a conduction calorimeter. Heat evolution of the concrete can also be measured directly by a calibrated calorimeter. Several such instruments are commercially available. They consist of a calibrated insulated container that measures the heat flow out of a cylinder of fresh concrete.

The adiabatic (without loss or gain of heat from the surroundings) temperature rise of the concrete can be measured directly by Army Corps Method CRD-C 38.

It should be noted that the actual temperature rise of a concrete pavement is only a fraction of that of the adiabatic temperature rise because the large surface-to-volume ratio of a pavement allows heat to escape almost as rapidly as it is generated.

Semi-adiabatic calorimetry (ASTM C1753) is proving a useful tool in observing the hydration kinetics of a mixture, thus flagging potential interactions between the reactive ingredients, as well as measuring comparative heat gain and initial setting time (Figure 6-8).

Pavement temperatures and the associated risk of cracking can be estimated with finite element software or by the Schmidt method (a finite difference method) described in ACI 207.1R-05 (reapproved 2012). The Federal Highway Administration's (FHWA's) HIPERPAV software (www.hiperpav.com) is a helpful analysis tool to determine early-age properties and the potential for cracking. Pavement temperatures measured with embedded sensors (ASTM C1064/AASHTO T 309) and environmental conditions monitored with a portable weather station (see [Concrete Temperature, Subgrade Temperature, and Project Environmental Conditions in Chapter 9](#)) are HIPERPAV data inputs.

Coefficient of thermal expansion can be measured using the method described in AASHTO T 336 (Figure 6-9) (see [Coefficient of Thermal Expansion in Chapter 9](#)). The test involves measuring the length change of a specimen observed due to a change in temperature of 72°F controlled using a water bath.



Figure 6-8. A typical field semi-adiabatic temperature monitoring system for mortar

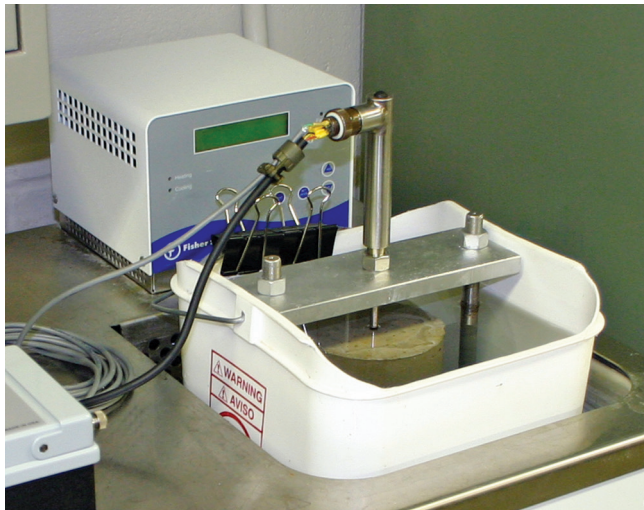

Figure 6-9. Measuring the coefficient of thermal expansion

Mechanical Properties

Strength and Strength Gain

Key Points

- Concrete strength is often used as an indicator of concrete quality, although this can be a false assumption.
- Sufficient concrete strength is needed to carry the loads.
- Strength increases with a decreasing w/cm ratio.
- Strength gain is accelerated at higher temperatures and decelerated at lower temperatures.
- Strength decreases as air content increases.
- Strength is measured in compression or in flexure (bending). In general, concrete has significantly more compressive strength than flexural strength.
- Early strength can be assessed in the field using maturity (time and temperature) measurements.

Simple Definition

Strength is a measure of the ability of concrete to resist stresses or forces at a given age.

Significance of Strength and Strength Gain

Strength is the most commonly measured property of concrete and is often used as the basis for assessing concrete quality. This is partly because strength measurements give a direct indication of concrete's ability to resist loads and partly because strength tests are relatively easy to conduct. The age at which a given strength is required will vary depending on the need. Contractors may want early strength (rapid strength gain) in order to put construction traffic on the pavement, while the owner may be interested only in the strength at a later age. The rate of strength development will also influence the risk of cracking (see [Early-Age Cracking](#) later in this chapter.)

Some people rely on strength measurements as indicators for other concrete properties, such as abrasion resistance or more broadly as a surrogate for potential durability. A word of caution: this correlation between strength and other properties is not necessarily accurate. In many cases, strength alone is not sufficient to determine the suitability of a concrete for a specific application. Specific properties should be tested according to relevant standards, not correlated to strength measurements. For instance, high early strength achieved by chemical admixtures or heating will often result in a poorer microstructure, higher permeability, and loss of potential durability.

Concrete is generally strong in compression, meaning it can resist heavy loads pushing it together. However, concrete is much weaker in terms of tension, meaning that the concrete is relatively weak in resisting forces pulling it apart.

Most loads on pavements (see Figure 6-10) result in bending (or flexure), which introduces compressive stresses on one face of the pavement and tensile stresses on the other. The concrete's compressive strength is typically much greater than the compressive stresses caused by the load on the slab. However, the tensile strength is only about 10 percent of the compressive strength. As a result, most slab failures are in flexure rather than in compression. Consequently, the flexural stress and the flexural strength (modulus of rupture [MOR]) of the concrete are used in pavement design to determine required slab thickness.

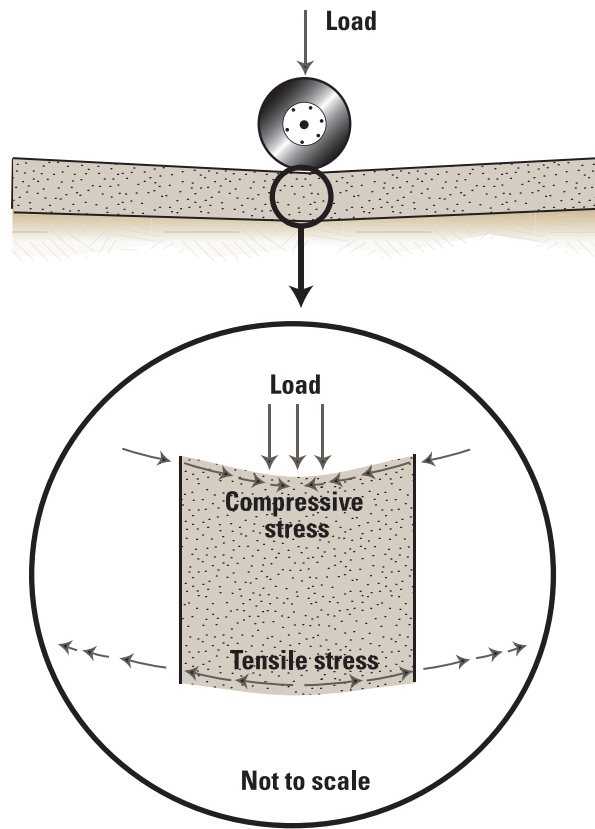

ACPA, used with permission

Figure 6-10. Loads on a pavement induce flexural stresses in the concrete slab

Another key strength parameter of concrete for pavements is fatigue, or the concrete's ability to carry repeated loading and unloading. Under fatigue, repeated loading will first result in the formation of small microcracks, some of which will grow into macrocracks, which then propagate with every load cycle.

Factors Affecting Strength and Strength Gain

Fundamentally, strength is a function of the volume of voids in the concrete. Voids provide a shortcut for cracks propagating through the matrix. These voids may be large, such as entrapped air voids resulting from poor consolidation, or small, such as capillary voids left after excess water has evaporated from the paste.

The primary factors that influence strength in well-compacted concrete, therefore, are the w/cm ratio, which directly influences the volume of capillary pores, and the extent to which hydration has progressed. These and other factors are discussed below (Table 6-3).

Water/Cementitious Materials Ratio

Strength increases as the w/cm ratio decreases because the capillary porosity decreases. This observation holds for the entire range of curing conditions, ages, and types of cements considered. Remember, however, that although there is a direct relationship between w/cm ratio and strength, concretes with the same w/cm ratio but different constituents are expected to have different strengths.

Table 6-3. Factors affecting compressive and flexural strength

Areas	Factor	Pavement impact	Testing impact
Construction	Change in w/cm ratio	Higher w/cm = lower strength	Higher w/cm = lower strength
	Poor consolidation	Low strength	Lower strength if cores are tested
	Excessive vibration	Segregation may result in lower strength	Lower strength if cores are tested
	Improper curing	Lower strength	Lower strength if cores are tested
	Reduced air content	Higher strength	Higher strength if cores are tested
	Increased air content	Lower strength	Lower strength if cores are tested
Sampling	Nonrepresentative, segregated sample	Lower strength	Lower strength
Specimen casting	Poor consolidation	Low strength and high permeability	Lower strength
	Poor handling	Low strength and high permeability	Lower strength
Specimen curing	Specimen freezes or dries out	Higher strength than indicated	Lower strength
Specimen breaking	Rapid rate	Lower strength than indicated	Higher strength
	Poor end preparation	Higher strength than indicated	Lower strength

Degree of Hydration

Hydration begins as soon as cement comes in contact with water and continues as long as favorable moisture and temperature conditions exist and space for hydration products is available (although hydration slows significantly after a few days). As hydration continues, concrete becomes harder and stronger. Hydration proceeds at a much slower rate when the concrete temperature is low and accelerates when the temperature rises. Hydration (and thus strength gain) stops when there is insufficient water in the system.

Cement

Concrete strength is influenced by the composition and fineness, and perhaps by the amount, of the cement. The calcium silicate alite (C₃S) hydrates more rapidly than belite (C₂S) and contributes to early strength. C₂S hydrates more slowly but continues hydrating longer, thus increasing later strengths (see [Portland Cement Hydration in Chapter 5](#)). Finer cements hydrate faster than coarser cements and tend to have a limited later strength development (Figure 6-11).

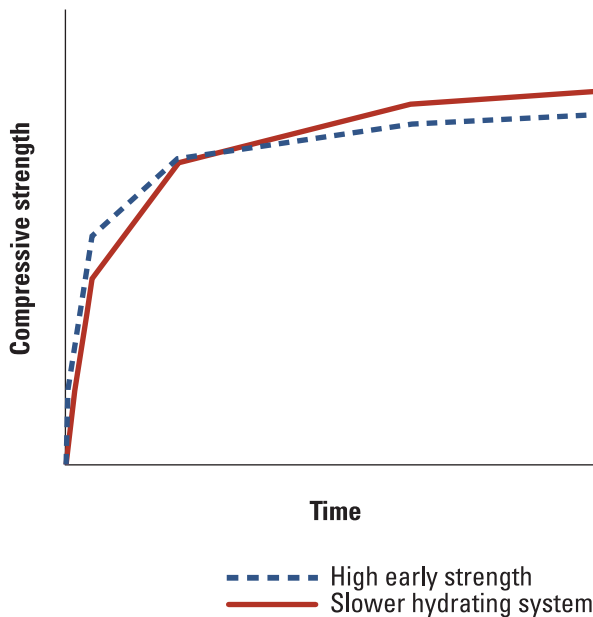

CTLGroup, used with permission

Figure 6-11. Cementitious systems that produce high early strengths tend to have lower strengths in the long term when compared to slower hydrating systems

Supplementary Cementitious Materials

SCMs contribute to the strength gain of concrete. However, the amount or rate of this contribution will depend on the chemistry, mineralogy, fineness, and amount of the SCM. Generally, with Class F fly ash slag cement, early strengths are lower than those of similar mixtures with portland cement only, yet ultimate

strengths are higher. The effect of Class C fly ash will go either way, depending on the specific fly ash used. Silica fume normally increases strengths at both early and later ages (although silica fume is not generally used in paving concrete). Mix proportions can be selected to achieve the required strengths with or without the presence of SCMs, but the majority of concrete mixtures include one or more SCM.

Air Content

As air content is increased, a given strength generally can be maintained by adjusting the w/cm ratio, something that can easily be accomplished without compromising workability through the use of water-reducing admixtures. Air-entrained as well as non-air-entrained concrete can readily be proportioned to provide required strengths.

Aggregate Bond

Rough and angular (including crushed) aggregate particles exhibit a greater bond with cement paste than aggregates with smooth and rounded surfaces. Large aggregates generally provide improved aggregate interlock at joints and cracks, increasing flexural strength.

Handling and Placing

Improper mixing, handling, and placing will affect concrete strength and strength gain. The on-site addition of water can markedly reduce strength (see [Water/Cementitious Materials Ratio on the previous page](#)). Concrete must be thoroughly compacted in order to reduce the void content of the mixture.

High Early-Strength Concrete

The period in which a specified concrete strength is achieved may range from a few hours to several days. High early-strength concrete achieves its specified strength (*f*'*c*) at an earlier age than normal concrete.

High early strength can be obtained by using one or more of the following:

- Type III cement
- High cement content (675 to 850 lb/yd³)
- Low w/cm ratio (0.37 to 0.45 by mass)
- Higher freshly mixed concrete temperature
- Higher curing temperature
- Accelerating admixtures
- Insulation to retain heat of hydration
- Hydraulic nonportland high early-strength cement (e.g., calcium sulfoaluminate cement)

High early-strength concrete can be used for several applications, including cold-weather construction, rapid repair of pavements to reduce traffic delay, fast-track paving, and several others. In fast-track paving, using high early-strength mixtures allows traffic to open within a few hours after concrete is placed. See Kosmatka and Wilson (2016) for an example of a fast-track concrete mixture used for a bonded concrete highway overlay.

When designing early-strength mixtures, strength development is not the only criteria that should be evaluated; permeability, early stiffening, autogenous shrinkage, drying shrinkage, temperature rise, and other properties should also be evaluated for compatibility with the project. For more information on high early-strength concrete, consult the American Concrete Pavement Association (ACPA 1994).

Strength Testing: Mix Design Stage

Concrete strength is not an absolute property. Results obtained from any given concrete mixture will depend on specimen geometry and size, preparation, and loading method. Specifications therefore need to set out the test methods as well as the value to be achieved at a given age. Variability is inherent in the test methods and materials. Therefore, trial mixes should yield strengths somewhat higher than the minimum specified (see *Sequence of Development in Chapter 7, Quality Control in Chapter 9*, and ACI 214R-11).

Strength is generally expressed in lb/in^2 at a specified age. Seven-day strengths are often estimated to be about 75 percent of the 28-day strength, and 56-day and 90-day strengths are about 10 to 15 percent greater, respectively, than 28-day strengths.

Compressive strength is normally measured by loading a cylinder of concrete at its ends (ASTM C 39). Testing the tensile strength of concrete is difficult; it is normally determined indirectly by using a bending test on a beam (ASTM C78) or by using a split tensile test (ASTM C496), in which a line load is applied on opposite sides of a cylinder.

Fatigue is normally tested by cyclically loading a concrete beam with a maximum load somewhat less than the concrete's ultimate capacity. The number of cycles before the beam fails, then, indicates the specimen's fatigue capacity.

Mix Design Testing: Flexural Strength

A parameter commonly used to assess pavement strength is flexural strength, or MOR, because that is the critical mode of loading. Flexural strength is

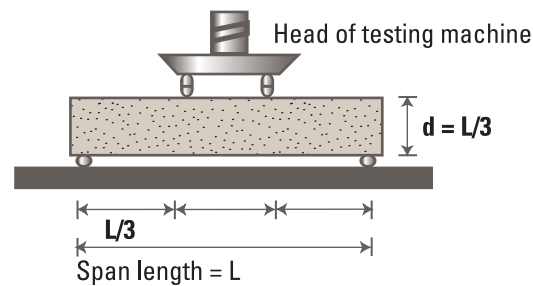

PCA, used with permission

Figure 6-12. In third-point loading, the entire middle one-third of the beam is stressed uniformly, and thus the beam fails at its weakest point in the middle one-third of the beam

determined in accordance with ASTM C78/AASHTO T 97 (third-point loading) (Figure 6-12). Some agencies use the center-point flexural strength test (ASTM C293/AASHTO T 177), particularly to assess whether the pavement can be opened to traffic.

The AASHTO thickness design is based on flexural strength measured using the third-point loading test. If strength values are measured using some other test method, the results must be converted using an appropriate correlation. Published conversion factors are necessarily generic, and it is advisable to develop the relationships for a specific mix if they are to be used in a contract.

Specimens for flexural strength testing are large and somewhat difficult to handle. Measurements of flexural strength are more sensitive than measurements of compressive strength to variations in test specimens and procedures, especially the moisture condition during testing.

Mix Design Testing: Compressive Strength

Compressive strength is the parameter normally used in structural concrete specifications. The compressive strength of concrete cylinders or cores (ASTM C39/AASHTO T 22) can be used as an alternative to flexural strength testing for opening and/or acceptance, if so specified. Usually, it is necessary to establish a mixture-specific correlation between flexural and compressive strengths. It should be noted that core strengths will normally be lower than cylinder strengths for the same mixture.

Mix Design Testing: Splitting Tensile Strength Tests

The splitting tensile test involves loading a cylinder or core axially along a strip on its side (ASTM C496) until a crack forms down the middle, causing failure of the specimen (Figure 6-13). The loading induces tensile stresses on the plane containing the applied load, causing the cylinder to split.



Figure 6-13. Splitting tensile strength

Strength Testing: Field Tests

Strength tests of hardened concrete can be performed on the following:

- Cured specimens molded in accordance with ASTM C31 or C192/AASHTO T 23 and T 126 from samples of freshly mixed concrete.
- In situ specimens cored or sawed from hardened concrete in accordance with ASTM C42/AASHTO T 24. ACI 308R-16 states that compressive strength of cores is required to average 85 percent of strength with no individual core less than 75 percent.

Samples prepared and cured in the field are likely to show a different (often lower) strength than samples prepared and cured in the laboratory because of the greater variability in the field. The resulting strength reported is the specimen strength and not that of the in-place pavement.

Laboratory-cured specimens are used to determine the specified concrete strength within a designated time period. Test specimens cast in the field at the time of concrete placement are normally used to determine when the concrete has gained enough strength to be opened to traffic. In situ cores extracted from the pavement are often used to verify the in-place concrete strength.

Cylinder size can be 6 × 12 in. or 4 × 8 in., provided that the diameter of the mold is at least three times the maximum-size aggregate. The 4 × 8 in. cylinders will generally have a higher compressive strength than 6 × 12 in. specimens made from the same concrete mixture.

Test results are greatly influenced by the conditions of the cylinder ends and cores. Therefore, for compression testing, specimens should be ground or capped. ASTM

C617/AASHTO T 231 outline methods for using sulfur mortar capping. ASTM C1231 describes the limits and use of unbonded neoprene caps that are not adhered or bonded to the ends of the specimen.

Testing of specimens should be performed in accordance with the following specifications:

- ASTM C39/AASHTO T 22 for compressive strength
- ASTM C78/AASHTO T 97 for flexural strength using third-point loading
- ASTM C293/AASHTO T 177 for flexural strength using center-point loading
- ASTM C496/AASHTO T 198 for splitting tensile strength

The moisture content of the test specimen has a considerable effect on the resulting strength. Testing should be performed on a test specimen that has been maintained in a moist condition (the surface has not been allowed to dry). Beams for flexural tests are especially vulnerable to moisture gradient effects. A saturated cylinder specimen will show lower compressive strength and higher flexural strength than those for companion specimens tested dry. This is important to consider when cores taken from hardened concrete in service are compared to molded specimens tested as taken from the moist-curing room or water storage tank.

Maturity Testing

Maturity methods have been used extensively to predict the in-place strength and strength gain of concrete. The basis for this method is simple: the strength and modulus of elasticity ([see Modulus of Elasticity and Poisson's Ratio in the next section of this chapter](#)) of a concrete specimen are directly related to the quantity of heat developed from the hydrating cement.

The practical benefit of this method is that field evaluations of in-place strength can be predicted from simple measurements of the concrete temperature over time. Maturity testing can be effective when making decisions about opening pavements to traffic.

The theoretical benefit is the ability to accurately predict both the strength and modulus of elasticity of concrete over a wide range of conditions based simply on the temperature development in the modeled pavement.

Maturity testing is most useful in estimating the in-place properties of concrete. However, it is also useful in developing concrete mixes. When insufficient time is available to adequately test a concrete mix before it is

used on a project, maturity tests can be used to predict later-age strengths. In this regard, concrete specimens can be cured at elevated temperatures and, using an assumed or empirically determined maturity constant, the measured strength development can be correlated back to the strength development if the concrete were cured at standard conditions.

The basis of maturity testing is that each concrete mix has a unique strength-time relationship. Therefore, a mix will have the same strength at a given maturity no matter what conditions (time or temperature) occur before measurement. Maturity testing entails developing a maturity curve that correlates the development of particular concrete properties for a specific concrete mix to both time and temperature. After the maturity curve is developed, development of the concrete property can be estimated from a measured time-temperature record of the concrete. The maturity function is a mathematical expression to account for the combined effects of time and temperature on the strength development of concrete. The key feature of a maturity function is the representation of the way temperature affects the rate of strength development.

ASTM C918 uses the maturity method of monitoring the temperature of cylinders cured in accordance with standard methods outlined in ASTM C31/AASHTO T 23. Cylinders are tested at early ages beyond 24 hours, and the concrete temperature history is used to compute the maturity index at the time of the test. Using historical data, a prediction equation is developed to project the strength at later ages based on the maturity index and early-age strength tests. See Carino (1994) for more information.

ASTM C1074 provides procedures for using the measured in-place maturity index to estimate in-place strength (Figure 6-14) (see Chapter 9). This practice describes two maturity functions. The first, and most popular for use with concrete pavements, is the time-temperature factor.

$$M(t) = \sum (T_a - T_o) \Delta t \quad (6.1)$$

where:

$M(t)$ = the time temperature factor at age t

Δt = time interval

T_a = average concrete temperature during the time interval

T_o = datum temperature

The other (preferred) maturity equation is the equivalent-age function. This function presents maturity in terms of the equivalent age of curing at standard laboratory conditions. Although the equivalent-age maturity function presents results in a more understandable format (the equivalent age), the complexity of its equation is likely why this method is less popular than the time-temperature factor method.

$$t_e = \sum e^{-Q(\frac{1}{T_a} - \frac{1}{T_s})} \Delta t \quad (6.2)$$

where:

t_e = equivalent age at a specified temperature T_s

Q = activation energy divided by the gas constant

T_a = average concrete temperature during the time interval

T_s = specified temperature

Δt = time interval

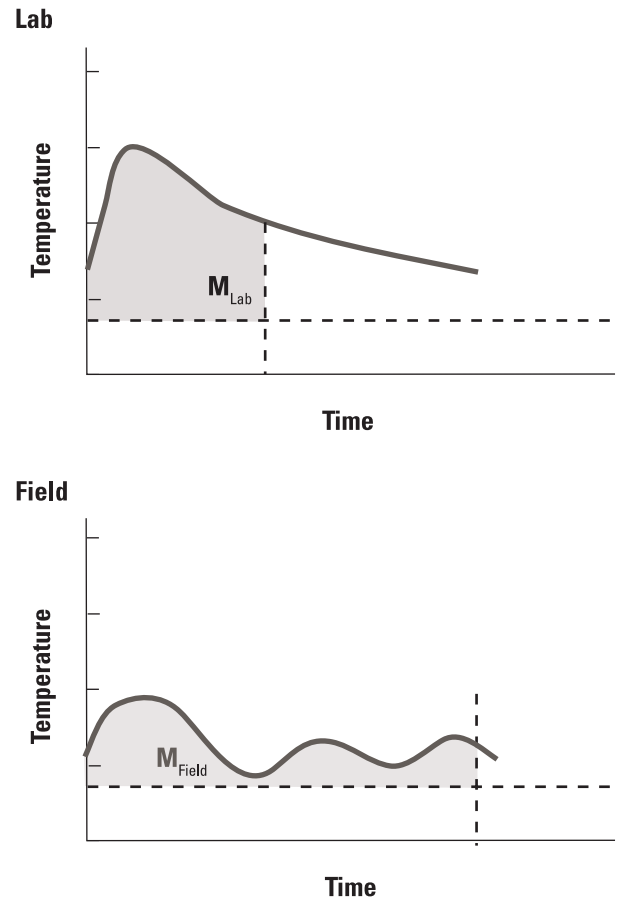

CTLGroup, used with permission

Figure 6-14. Maturity of the field concrete is equivalent to maturity of the laboratory concrete when the area under the curves is the same

Equivalent age is expected to provide more accurate results when large temperature changes occur in the field. However, the time-temperature method is easier to apply and has been successfully used for estimating the in-place strength of paving concrete. Each of these functions requires preliminary testing to relate to the strength of concrete. Each method has a constant that can be assumed or (for accuracy) determined for the specific mix (ASTM C1074). In the time-temperature factor, a datum temperature below which hydration is minimal can be determined experimentally. In the equivalent-age method, an activation energy is calculated.

Maturity can be determined with commercially available test equipment or with standard temperature logging equipment and an understanding of maturity (see [Concrete Maturity in Chapter 9](#)). In either case, temperature sensors must be placed at the critical locations in the concrete. For most pavements, this will be either at the top or bottom surface, although state agencies most commonly specify that the probe be at midheight.

Commercially available maturity meters log the concrete temperature as a function of time and present the current maturity (time-temperature factor or equivalent age) of the concrete. There are two primary types of maturity meters. The first type uses temperature sensors in the concrete with logging equipment outside the concrete. The second type combines the temperature sensor and logging equipment in a single package, which is embedded in the concrete. Wires extend from the sensor outside the concrete. These wires must be periodically connected to a handheld reader so that the maturity data from the sensor can be read. Wireless equipment is also available.

Maturity can also be calculated from temperature sensors (like thermocouples, thermometers, or thermistors) embedded in the concrete. The time interval should be selected to adequately resolve temperature changes in the concrete. Some states require twice daily readings, although more frequent intervals would improve accuracy.

Modulus of Elasticity and Poisson's Ratio

Key Points

- Concrete's modulus of elasticity generally correlates with the strength of the concrete and the type and amount of the aggregate.
- Modulus of elasticity is used in structural design of concrete pavement and for modeling the risk of cracking in concrete pavement.
- Poisson's ratio is normally about 0.2 in hardened concrete.
- Similar to the prediction of concrete strength, maturity methods can be used to predict the modulus of elasticity.
- Testing specifications: ASTM C469 (dynamic modulus); ASTM C215).

Simple Definition

The modulus of elasticity, or stiffness, of concrete is a measure of how much the material will deflect under load and indicates risk of cracking. Poisson's ratio is a measure of deflection that is perpendicular to the load.

Significance of Modulus of Elasticity

The modulus of elasticity parameter is used in the structural design of the pavement and for modeling the risk of cracking. Strictly defined, the modulus of elasticity is the ratio of stress to corresponding strain for loads up to about 40 percent of the ultimate strength (Figure 6-15). (Dynamic modulus is the response of concrete to dynamic rather than static loading. The dynamic modulus of concrete is normally about 10 percent higher than the static modulus.)

Normal-density concrete has a modulus of elasticity of 2 million to 6 million lb/in², depending on factors like compressive strength and aggregate type. For normal-density concrete with compressive strengths between 3,000 and 5,000 lb/in², the modulus of elasticity can be estimated as 57,000 times the square root of strength in lb/in². Several formulas have been suggested for high-strength concrete (Farny and Panarese 1993).

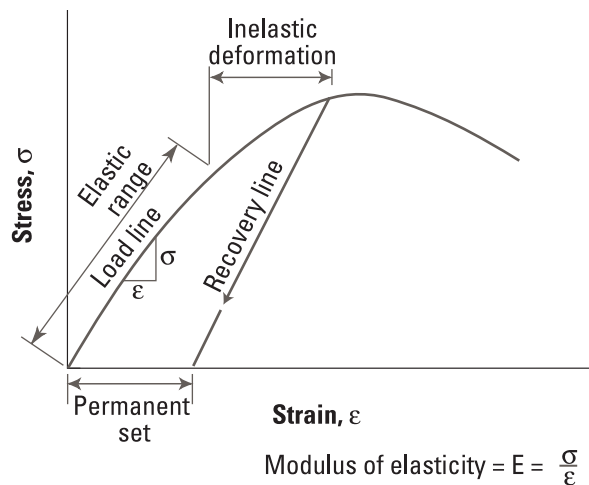

PCA, used with permission

Figure 6-15. Generalized stress-strain curve for concrete

Like other strength relationships, the relationship of modulus of elasticity to compressive strength is specific to mix ingredients and should be verified in a laboratory (Wood 1992).

Poisson's ratio is a measure of the deflection that is perpendicular to the direction of the load. A common value used for concrete is 0.20, but the value may vary from 0.15 to 0.25 depending on the aggregate, moisture content, concrete age, and compressive strength. Poisson's ratio is required in some numerical models for concrete performance such as AASHTOWare Pavement ME Design software.

Factors Affecting the Modulus of Elasticity

Modulus of elasticity generally increases with an increase in compressive strength. It is primarily affected by the modulus of elasticity of the aggregate and by the volumetric proportions of the aggregate in concrete (Baalbaki et al. 1991). If an aggregate has the ability to produce a high modulus, then the highest modulus in concrete can be obtained by using as much of this aggregate as practical while still meeting workability and cohesiveness requirements.

Testing for Modulus of Elasticity and Poisson's Ratio

Static modulus of elasticity and Poisson's ratio of concrete in compression are tested according to ASTM C469. Specimens can be concrete cylinders or cores. In the ASTM C469 test procedure, the cylinder is loaded to 40 percent of the concrete compressive strength.

In order to determine the 40 percent load, it is first necessary to determine the concrete compressive strength on companion specimens. This requires a machine with adequate capacity to break the cylinders.

Dynamic modulus can be determined by using ASTM C215, in which the fundamental resonant frequency is recorded in a sample struck with a small hammer. The dynamic modulus is calculated from the recorded frequency.

Similar to the prediction of concrete strength, maturity methods can be used to predict the actual modulus of elasticity.

Shrinkage

Key Points

- Concrete shrinkage occurs due to a number of mechanisms starting soon after mixing and continuing for a long time, primarily due to moisture loss.
- Shrinkage primarily increases with increasing water (paste) content in the concrete.
- Testing specifications: ASTM C157/ AASHTO T 160.

Simple Definition

Shrinkage is a decrease in length or volume of the concrete due to moisture loss.

Significance of Shrinkage

Starting soon after mixing and continuing for months and even years, concrete shrinks because of several mechanisms. Because concrete is generally restrained in some way, concrete shrinkage almost always results in cracking. Uncontrolled cracks that form at early ages are likely to grow because of mechanical and environmental stresses that would otherwise be of no concern. Therefore, minimizing uncontrolled early shrinkage cracking can prolong the service life of the concrete.

Factors Affecting Shrinkage

Soon after concrete is placed, it shrinks because of chemical changes and loss of moisture (Wang 2012):

- Autogenous shrinkage is the amount of chemical shrinkage that can be measured in a sample. (Chemical shrinkage occurs because the volume of the hydration products of cement occupies less space than the original materials and because at low w/cm ratios there is insufficient water in the system to hydrate all of the cement, leading to desiccation of the capillary pores.) Autogenous shrinkage is normally insignificant in concrete with a high w/cm ratio, but it becomes important when the w/cm ratio is below 0.40. The difference is observed as microcracking in the matrix. A w/cm ratio below about 0.38 is not recommended for slipform paving, although some states have had success with w/cm ratios as low as 0.37.
- Concrete shrinks as moisture is lost from the system.
 - Plastic shrinkage occurs before the concrete sets and is primarily due to loss of moisture from the surface of fresh concrete. It can result in plastic cracking in the surface.
 - Drying shrinkage occurs after the concrete has set. If the shrinkage is restrained, drying shrinkage cracking will occur (see [Early-Age Cracking](#) later in this chapter.)

In addition, concrete shrinks somewhat as it settles and contracts as it cools (see [Temperature Effects](#) earlier in this chapter). All of these shrinkage effects are additive; therefore, reducing any one of them will reduce the risk of cracking (Figure 6-16).

The most important controllable factor affecting drying shrinkage is the amount of water per unit volume of concrete (Figure 6-17) (Wang 2012). Total shrinkage can be minimized by keeping the water (or paste) content of concrete as low as possible. The higher the cement content of a mixture, the greater the magnitude of likely drying shrinkage. The paste content can be minimized by keeping the total coarse aggregate content of the concrete as high as possible while achieving workability and minimizing segregation. Paste content should be less than 25 percent by volume of concrete (AASHTO PP 84).

Several mixtures with various proportions are represented within the shaded area of the curves. Drying shrinkage increases with increasing water contents.

Drying shrinkage may also be reduced by avoiding aggregates that contain excessive amounts of clay in

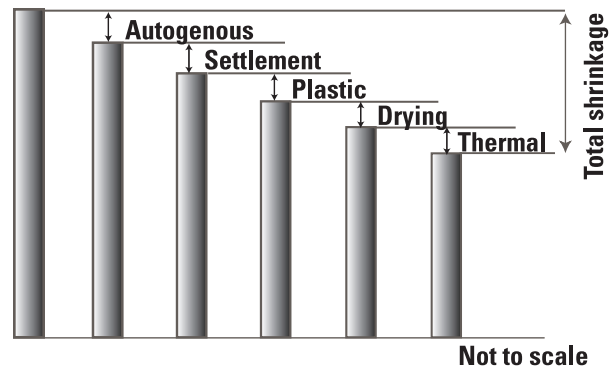

CTLGroup, used with permission

Figure 6-16. Total shrinkage is a sum of all individual shrinkage mechanisms. Minimizing any or all of the mechanisms will reduce the risk of cracking

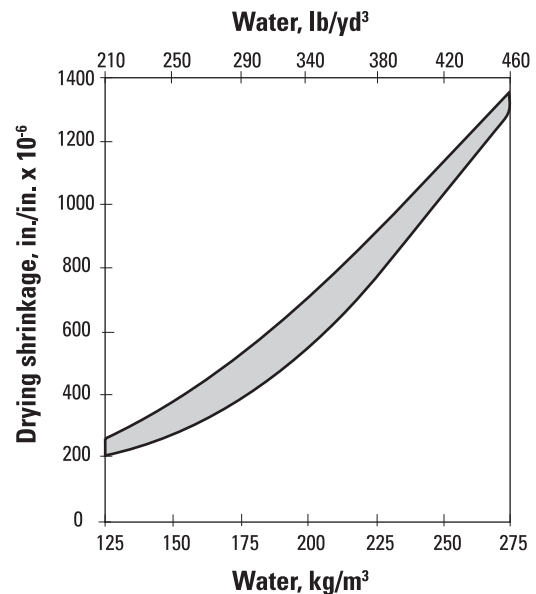

PCA, used with permission

Figure 6-17. Relationship between total water content and drying shrinkage

their fines. Quartz, granite, feldspar, limestone, and dolomite aggregates generally produce concretes with low drying shrinkages.

Weather—air temperature, wind, relative humidity, and sunlight—influences concrete hydration and shrinkage. These factors may draw moisture from exposed concrete surfaces with resultant slowing of hydration and increased warping (see [Curling and Warping: A Variation of Volume Change under Early-Age Cracking](#) later in this chapter).

Cement types and SCMs usually have little direct effect on shrinkage.

Testing for Shrinkage

Limits to changes in volume or length are sometimes specified for concrete pavements. Volume change should also be tested when a new ingredient is added to concrete to make sure that there are no significant adverse effects.

ASTM C157/AASHTO T 160 are commonly used to determine length change in unrestrained concrete due to drying shrinkage. Since the rate and magnitude of shrinkage are influenced by specimen size, any specification based on ASTM C157 must include the specimen size. The standard procedure is to take an initial length measurement at 24 hours. The specimens are then stored in lime-saturated water for 27 days, when another length measurement is taken. All specimens are then stored in air at a constant humidity and temperature until 64 weeks. (Because most projects cannot wait 64 weeks, an alternative set of initial reading, drying age, and final reading age is sometimes specified.)

Abrasion Resistance

Key Points

- Abrasion resistance is important for maintaining adequate texture and skid resistance on the concrete pavement surface, especially surfaces subjected to studded tire or chain wear.
- For satisfactory abrasion resistance, consider the following procedures:
 - Select strong and hard aggregates.
 - Use high compressive strength concrete.
 - Provide proper finishing and curing.
- Testing specifications: ASTM C418, ASTM C779, ASTM C944, ASTM C1138.

Simple Definition

Abrasion resistance is concrete's ability to resist surface wear.

Significance of Abrasion Resistance

Pavement surfaces must maintain adequate texture and skid resistance for proper vehicular control. It is therefore important for concrete pavements to have a high abrasion resistance. Abrasion resistance is generally related to the concrete's compressive strength and to the type of aggregate in the concrete; harder aggregates resist wear better than softer aggregates.

Skid resistance is affected by both the concrete's microtexture (provided by the type and hardness of fine aggregate particles) and the macrotexture (primarily provided by texture formed on freshly placed concrete or cut in the hardened concrete [ACI 325.9R-15]). Wear of pavement surfaces occurs due to the rubbing action from the wheels of vehicular traffic. The rubbing action is greatly increased by the presence of abrasive particles, such as fine aggregates mixed with deicing chemicals (ACI 201.2R-16, Liu 1994).

Wear is usually minimal with concrete pavements unless vehicles with studs, chains, or metal wheels travel on the pavement or unless poor aggregates and concrete are used. Even with minimal wear, polished surfaces can occur unless proper aggregates are selected. With more wear, loss of texture and loss of thickness can occur.

Extreme wear has been encountered in wheel paths on pavements subjected to studded tires and tire chains used in winter conditions on some alpine routes in the western US. Under these conditions, hard coarse aggregates and a strong cement paste must be used to help reduce the rate at which damage accumulates.

Factors Affecting Abrasion Resistance

The main factors affecting abrasion resistance are the type of aggregate, compressive strength, surface finishing, and curing methods (ACI 201.2R-16, Liu 1994).

Aggregate Type

Coarse aggregate has a large influence on abrasion resistance, and the use of hard aggregates, such as granite and traprock, is preferred. Soft limestone has poor abrasion resistance, but dolomitic limestone may have very good resistance.

To provide good skid resistance on pavements, the siliceous particle content of the fine aggregate should be at least 25 percent by mass of fine aggregate. Certain manufactured sands produce slippery pavement surfaces and should be investigated for acceptance before use.

Compressive Strength

A high concrete compressive strength improves abrasion resistance. High strength is achieved by having strong paste and a strong bond between the aggregate and paste, thus preventing dislodging of aggregates out of the paste. The w/cm ratio has a large effect on the abrasion resistance because it relates to the compressive strength. The compressive strength at the surface is important and is improved by avoiding segregation, eliminating bleeding, and using proper finishing and curing procedures (ACI 201.2R-16). Supplementary cementitious materials do not affect the abrasion resistance, provided that strength levels are maintained.

Surface Finishing

Techniques that densify the surface will increase abrasion resistance.

Curing Methods

Increased curing promotes cement hydration, thus improving abrasion resistance.

Testing

The most common test for abrasion resistance of aggregate is the Los Angeles (LA) abrasion test (rattler method) performed in accordance with ASTM C131 or ASTM C535/AASHTO T 96. In this test, a specified quantity of aggregate is placed in a steel drum containing steel balls, the drum is rotated, and the percentage of material worn away is measured. Specifications often set an upper limit on this weight loss. However, a comparison of the results of aggregate abrasion tests with the abrasion resistance of concrete made with the same aggregate do not show a clear correlation. The MicroDeval test, developed in France during the 1960s, is an alternative to the LA abrasion test (Kandhal and Parker 1998).

The wear resistance of concrete is determined more accurately by abrasion tests of the concrete itself. Four standard tests measure the abrasion resistance of concrete under various conditions.

ASTM C418 subjects the concrete surface to air-driven silica sand, and the loss of volume of concrete is determined.

In ASTM C779, three procedures simulate different abrasion conditions:

- Procedure A: Sliding and scuffing of revolving steel disks in conjunction with abrasive grit
- Procedure B: Impact and sliding friction of steel dressing wheels riding in a circular path
- Procedure C: A rapidly rotating ball bearing under load on a wet concrete surface, causing high contact stresses, impact, and sliding friction

In all three procedures, the depth of wear of the specimen is used as a measure of abrasion.

In ASTM C944, a rotating cutter abrades the surface of the concrete under load. Loss of mass or depth of wear is measured. This test is similar to Procedure B of test method ASTM C779 (Figure 6-18); however, ASTM C944 can be performed on cores.

In ASTM C1138, concrete is subjected to waterborne particles, which simulates the condition of hydraulic structures.



Figure 6-18. Rotating cutter with dressing wheels for the ASTM C944 abrasion resistance test

Key Points

- Concrete shrinks and expands due to moisture and temperature changes, and it will crack when the stress from restrained shrinkage exceeds the concrete's strength.
- The number and location of shrinkage cracks can be controlled by the timely construction of joints at optimum spacing and depth.
- Good practices by designers and contractors will help ensure that cracks develop only at joints and that little, if any, random cracking occurs.
- Good curing practices can reduce or prevent random cracking because curing helps delay the onset of stresses until the concrete is strong enough to avoid cracking.
- Good support is essential for preventing cracking due to loads.
- If concrete sets at a high temperature, the stresses and risk of cracking are increased.
- Standard test methods to determine restrained shrinkage cracking potential include ASTM C1581, AASHTO T 334, and AASHTO TP 363.

Simple Definition

Concrete cracks when tensile stresses exceed tensile strength. For the purposes of this manual, early-age cracks are defined as those that occur before the concrete pavement is opened to public traffic and are predominately related to the early-age properties of the concrete, restraint, and prevailing environmental conditions.

Later-age cracks are caused by a number of mechanisms, including traffic loading and materials-related distress (see [Resistance to Freezing and Thawing](#), [D-Cracking](#), [Sulfate Resistance](#), and [Alkali-Silica Reaction](#) later in this chapter).

Significance of Early-Age Cracking

Although cracking is not strictly a property of concrete, concrete always cracks. A certain amount of early-age, full-depth cracking to relieve tensile stresses is inevitable. This does not normally pose a problem as long as good curing practices are used and the location of the cracking is anticipated and controlled. Ideally, the concrete will crack through the slab at locations where load-transfer devices are placed to keep cracks tight. Controlled cracks at joints are aesthetically acceptable and can be sealed to reduce the ingress of aggressive fluids and incompressible materials. Undesirable slab movement at joints can be controlled by installing dowels across transverse joints (to prevent vertical movement) or tiebars across longitudinal joints (to prevent horizontal movement).

Random (uncontrolled) cracks, however, are undesirable. They can reduce ride quality and lead to reduced durability. Although some random cracks are at first only cosmetic flaws, or are even invisible to the naked eye, these cracks can grow and become problematic because of mechanical and environmental stresses that would otherwise be of no concern.

Early-age cracking occurs during the first few days of a pavement's life. This cracking is generally due to a combination of several factors, primarily thermal contraction and drying shrinkage (see the sections on [Temperature Effects](#) and on [Shrinkage](#) earlier in this chapter). Thermal-related cracks are normally observed in the first day, whereas drying-related cracks may appear over a longer period.

To control early-age cracks and prevent random cracks, designers and construction personnel need to understand the mechanisms that cause them.

Factors Affecting Early-Age Cracking

The primary factors affecting early-age concrete pavement cracking include the following:

- Volume change (drying shrinkage, thermal contraction) and restraint
- Curling and warping
- Strength and stiffness
- Base stiffness and friction
- Early loadings (including the weight of the concrete itself)

These factors are affected by decisions made during pavement design, mixture design and proportioning, and construction. Cracking rarely occurs as a result of just one of these factors, but rather it is generally a cumulative effect of several factors. In addition, weather conditions can greatly affect the magnitude and/or impact of each factor.

Volume Change and Restraint

Concrete always changes in volume (expands or shrinks) because of the effects of changing temperature and moisture (see [Temperature Effects](#) and [Shrinkage](#) earlier in this chapter).

Volume change can occur due to moisture loss before or after setting (plastic shrinkage and drying shrinkage, respectively) or due to a temperature drop after the concrete has set (thermal contraction). Thermal contraction can be 0.17 to 0.42 in./100 ft for a 40°F temperature change, depending on the aggregate type (see [Temperature Effects](#) earlier in this chapter and [Aggregate Coefficient of Thermal Expansion](#) and [Aggregate Durability](#) in Chapter 4).

Drying shrinkage can be significantly greater (0.48 to 0.96 in./100 ft) depending primarily on the volume of the paste, but it will take several months to achieve these levels.

In general, an object can shrink or contract freely without any stress induced in the system as long as it is not restrained. Theoretically, in homogeneous, elastic, unrestrained concrete systems (for example, in space where there is no gravity or friction), shrinkage is not a problem; the whole slab simply gets smaller (Figure 6-19 [top]).

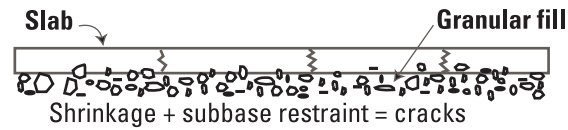
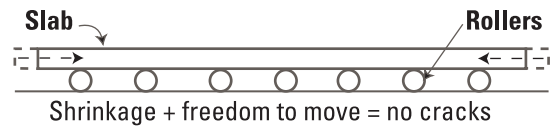

Not to scale

ACPA, used with permission

Figure 6-19. Cracks generally don't develop in concrete that is free to shrink (top), but slabs on the ground (in reality) are restrained by the subbase or other elements, creating tensile stresses and cracks (bottom)

If the shrinking concrete is restrained, however, tensile stresses develop in the concrete in proportion to the concrete stiffness and the degree of restraint (Figure 6-19 [bottom]). As noted earlier in this chapter, concrete's tensile strength is much less than its compressive strength. When the stress from restraint of shrinkage exceeds the concrete's tensile strength, a crack will form. This is generally called shrinkage cracking.

Both internal and external restraint can cause stress. Internal restraint can arise, for example, if the outer concrete shrinks while the core does not. External restraint can arise from bonding or friction between a slab and the base, from abrupt changes in the slab's cross section, or from an existing slab to which the new pavement is tied.

Curling and Warping: A Variation of Volume Change

Volume change can also cause curling and/or warping.

Curling

Curling is caused by differences in temperature between the top and bottom of the slab.

During cooler weather (e.g., at night or when a cold front comes through), the top surface of the slab cools more quickly than the bottom of the slab, which is insulated by the soil. The top part of the slab shrinks more quickly than the bottom, causing the slab to curl up at the edges (Figure 6-20a).

During hot weather conditions (typically, during the daytime), the top of the slab may be warmer than the bottom, resulting in curling in the opposite direction (Figure 6-20b).

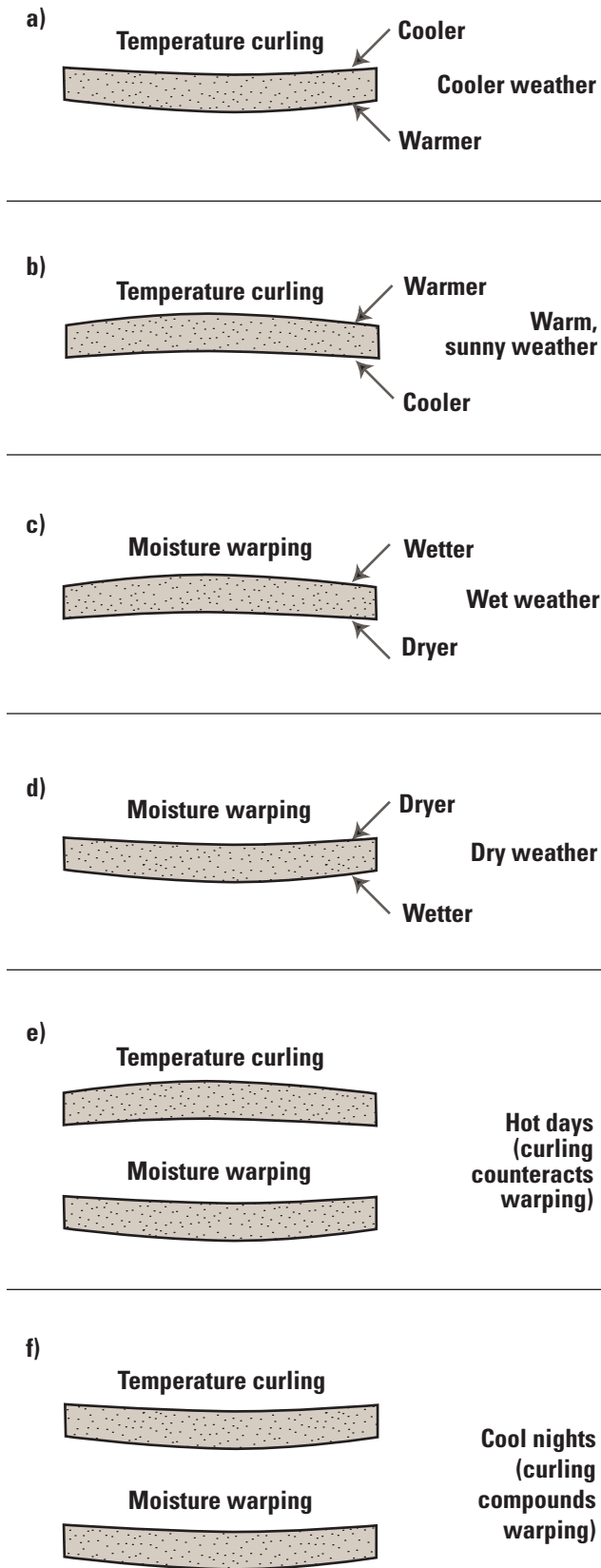

Figure 6-20. Curling and warping of slabs

Warping

Warping of concrete pavements is caused by differences in moisture content between the top and bottom of the slab.

Theoretically, if the bottom of the slab is drier than the top, downward warping may occur (Figure 6-20c). However, if the top of the slab is drier than the bottom, as is true in almost every case, including in arid climates, warping is in the upward direction (Figure 6-20d). This is because ground moisture tends to migrate toward the bottom of a slab. In addition, because a component of initial drying shrinkage is irreversible, slabs have a tendency to develop a permanent upward warp over time that can affect measured ride quality.

Curling and warping actions may offset or augment each other. During summer days, curling may be counteracted by warping (Figure 6-20e). During summer nights, curling may compound warping movement (Figure 6-20f).

Along the joints, the pavement edges tend to curl upward when the surface of the concrete is drier and cooler than the bottom. The curled edges then become a cantilever. Traffic passing over the joints causes a repetitive vertical deflection that creates a large potential for fatigue cracking in the concrete (Figure 6-21).

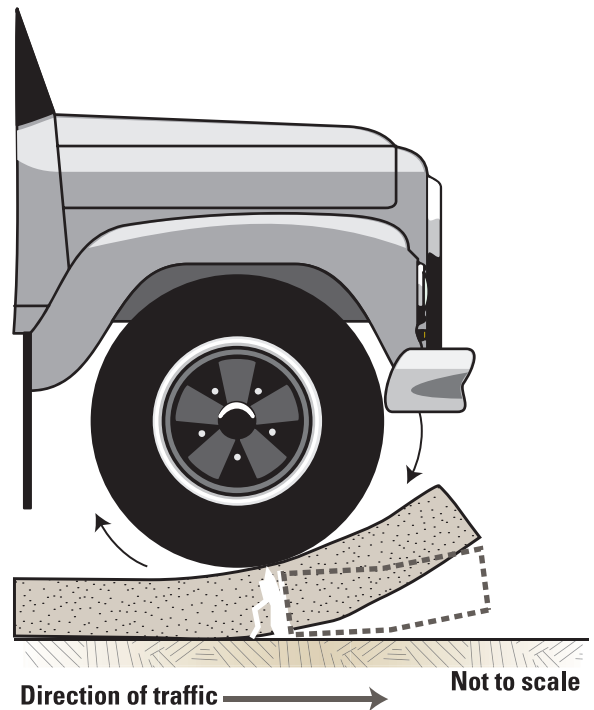

PCA, used with permission

Figure 6-21. Exaggerated illustration of pavement curling: the edge of the slab at a joint or a free end lifts off the base, creating a cantilevered section of concrete that can break off under heavy wheel loading

Strength and Stiffness

The ability of concrete to resist stresses introduced by volume change depends on the mixture's strength and the stiffness.

Strength

The greater the concrete strength, the greater the stress the concrete will be able to resist without cracking. This is why most early-age cracking occurs soon after the concrete has been placed, when strength is still developing but stresses related to thermal contraction and drying shrinkage are high (see [Strength and Strength Gain in this chapter](#)).

Stiffness

The stiffer the concrete (as indicated by modulus of elasticity), the greater the stresses resulting from a given volume change. Unfortunately, stiffness increases faster than strength for the first few hours after setting, increasing the risk of cracking if the concrete is allowed to experience significant temperature variations or moisture loss (see [Modulus of Elasticity earlier in this chapter](#)). Increasing strength also increases stiffness.

Lack of Support

If the concrete slab is not supported on a continuous, uniform base, then very high bending (and therefore tensile) stresses will be introduced, resulting in cracking. The loss of support may be due to the base material's lack of stability and uniformity or the erosion of the material over time (Figure 6-22). A very stiff base will provide little cushioning to a slab that is curled or warped, thus increasing load-induced stresses.

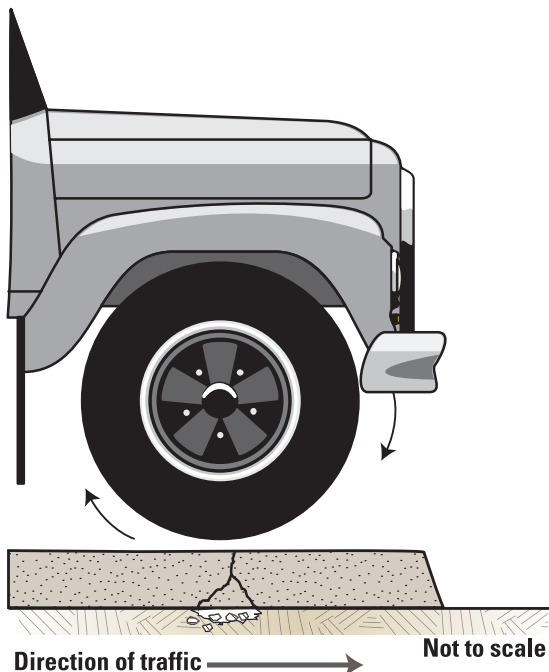

Figure 6-22. An eroded base can lead to high tensile stresses, resulting in cracking

Early Loading

Load is distributed through a concrete slab over a wide area, meaning that the base layer does not have to be particularly strong or stiff. However, at the edges and corners of a slab, there is less area to carry the load, resulting in higher loads and deflections in the base. This indicates that the edges and corners of a slab are particularly sensitive to loading (i.e., susceptible to cracking) before the concrete has gained sufficient strength.

It is therefore recommended that construction equipment be kept away from the edges of a fresh slab until a minimum strength of 300 lb/in² is achieved. When construction equipment (e.g., a sealing truck) is allowed on the slab, protect the slab edges with cones or other temporary barricades.

Controlling Early-Age Cracks

As noted earlier, concrete cracks because stresses develop in the concrete more quickly than the concrete's tensile strength develops. The goal is to control the number and location of cracks as much as possible and to prevent random cracks. This requires using good design and construction practices.

Controlling Early-Age Cracks with Joints

In jointed pavements (the majority of concrete pavements), the number, location, and size of early-age cracks is controlled by constructing (forming or sawing) contraction joints. The joints create planes of weakness where cracks form (Figure 6-23) (see [Joint Sawing in Chapter 8](#)).

To control cracking adequately, joints must be constructed correctly. In the case of sawed joints, this means that joints must be sawed at the correct time, at the correct spacing, and to the correct depth.



PCA, used with permission

Figure 6-23. A saw cut that has cracked through as planned

Timing: The Sawing Window

Joints are usually constructed by saw-cutting the concrete a few hours after placing. The optimum period of time to saw contraction joints is known as the sawing window.

The sawing window for conventional saws generally begins when concrete is strong enough not to ravel excessively along the saw cut. The window ends when shrinkage-induced stress results in uncontrolled cracking (Voigt 2000) (Figure 6-24). Good practice generally dictates that if the slab begins cracking in front of the saw, sawing should be stopped at that joint.

The beginning, duration, and end of the sawing window for any given concrete system are unique to that system. The sawing window is governed by the rate of hydration of the system and the environment to which it is exposed. An approach to estimating the time to start sawing has been reported by Wang et al. (2016).

Higher early-strength concrete will be able to withstand more tensile stress when it first cools and undergoes temperature differentials. However, the sawing window for concrete mixtures that gain strength rapidly may begin sooner and be shorter than for normal mixtures.

The use of lightweight, early-entry saws allows joints to be sawed earlier without raveling, within an hour or two of paving, and may reduce the risk of random cracking (see [Implications of Cement Hydration for Construction Practices in the Stages of Hydration](#) chart in Chapter 5; and [Saw Timing](#) in Chapter 8).

For early-entry saws, the sawing window begins at final set and ends when the shallower early-entry cut no longer creates an effective plane of weakness. It can be



ACPA, used with permission

Figure 6-24. This joint was cut too late, resulting in random transverse cracking

difficult to know when shallow early-entry saw cuts are no longer effective because the resulting random cracks are generally not visible until much later. Getting a good “feel” for the duration of early-entry sawing windows comes with experience.

Joint Spacing

When transverse joints are too far apart, the concrete may still crack randomly at locations other than the joints.

An optimal joint spacing exists for each specific project, depending on the slab thickness, base stiffness, and concrete strength. Most state agencies specify transverse contraction joints in plain (unreinforced) pavement at intervals between 13 and 18 ft.

For concrete pavements placed on granular subbase, the ACPA recommends a maximum spacing of $24d$, where “ d ” is the pavement depth; for concrete pavements placed on stabilized materials, a maximum spacing of $21d$ is recommended.

Joint Depth

The design depth of saw cuts is the minimum depth required to create a properly functioning joint. Cuts that are too shallow may not relieve stresses adequately, allowing random cracks to occur. Cuts that are unnecessarily deep require additional effort (i.e., more time), cause unnecessary equipment wear, and reduce aggregate interlock.

In general, the depth of conventional saw cuts is one-third of the pavement thickness. However, unless a state specifies otherwise, early-entry cuts can generally be approximately 1 to 1.5 in. deep, regardless of pavement thickness. Because early-entry saw cuts are made before the concrete has developed significant strength or stresses, this shallower cut will create an effective plane of weakness where a crack should form (see [Saw Timing in Chapter 8](#)). Early entry saws are not recommended for longitudinal joints.

Controlling Early-Age Cracks with Curing

To help ensure that cracks form only at the joints, the moisture and temperature control techniques discussed on the previous pages should be used. Curing helps delay the onset of shrinkage stresses until the concrete is stronger.

Note: In jointed continuously reinforced concrete pavements (CRCPs), the reinforcing steel causes cracks to develop within an acceptable spacing. The reinforcing steel also holds the cracks tightly together, limiting the infiltration of aggressive fluids and other materials that can reduce durability.

Preventing Early-Age Cracks

The following cracks are, at least theoretically, preventable:

- Random transverse and/or longitudinal cracks
- Plastic shrinkage cracks (short, shallow surface cracks that occur when the surface of the concrete dries too quickly)
- Map cracks (crazing), which occur primarily in hand pours
- Corner and edge cracks

These cracks are described in more detail in the section [Summary of Preventable Early-Age Cracks](#) in this chapter. They can be prevented by properly constructing joints, by controlling drying shrinkage and thermal contraction through good practices and a well-designed mix, and by providing a uniform, stable base.

Using Joints to Prevent Uncontrolled Early-Age Cracks

Under normal conditions, constructing an adequate system of joints in unreinforced concrete pavement will prevent the formation of random transverse and/or longitudinal cracks.

Selecting Materials to Prevent Early-Age Cracks

Another mechanism for controlling shrinkage is careful mix design/materials selection.

- Minimize the mix water content required for workability by avoiding the excessive use of cementitious materials, optimizing the size and amount of coarse aggregate, and minimizing the use of dusty aggregate. Limit the paste content to 25 percent by volume of concrete.
- Consider using a water-reducing admixture to obtain workability without adding extra water, reducing drying shrinkage.
- Avoid calcium chloride admixtures, which can significantly increase drying shrinkage.
- Reduce the absorption of mix water into aggregates (see [Stockpile Management](#) and [Batching under Concrete Production in Chapter 8](#)).
- Include a small amount of pre-wetted lightweight fine aggregate (LWFA) for the purposes of internal curing to initially reduce early shrinkage and moisture profiles in a slab, thus potentially reducing the risk of early-age cracking.

Note: Some bleeding of the concrete may help reduce the rate of surface moisture loss, but a mixture should not be designed to bleed excessively simply to avoid plastic shrinkage cracking.

Preventing Early-Age Cracks with Moisture Control

If the concrete surface dries too rapidly before initial set, the surface will experience plastic shrinkage cracking. Significant drying shrinkage after the concrete hardens may contribute to map cracking and random transverse or longitudinal cracking if the concrete is not strong enough for the stresses.

Even if the concrete is strong enough, early drying will exacerbate warping and thus contribute to fatigue cracking ([see Shrinkage earlier in this chapter](#)).

Therefore, controlling moisture is essential.

A critical mechanism for controlling moisture (and thus plastic shrinkage, drying shrinkage, and warping) is good curing (Taylor 2013).

- Apply curing compound as soon as possible after finishing.
- Apply curing compound early if no additional finishing is to be conducted.
- If the evaporation rate is high, apply an evaporation retarder to the surface of the concrete before the final finishing activities. (Evaporation retarders are not curing compounds and should not be used as finishing aids; although, they can be reworked into the surface of the concrete if applied in accordance with the manufacturer's recommendations.)
- In hot, dry, and/or windy conditions when evaporation is high, use wet initial curing methods, such as fog spray, to increase the relative humidity of the air above the surface until the liquid curing membrane can be applied.

Preventing Early-Age Cracks with Temperature Control

Changes in concrete temperature will result in thermal contraction and/or curling, which can contribute to random transverse or longitudinal cracking ([see Temperature Effects earlier in this chapter](#)).

Therefore, it is important to control changes in temperature.

First, reduce set temperature. Generally, this involves controlling the heat of hydration through the following activities:

- Use SCMs in the mix that reduce the heat and rate of hydration.
- Avoid or limit the use of fine cementitious materials such as Type III cement.
- Consider using a set-retarding admixture in the mix.
- Reduce the temperature of fresh concrete by using chilled water, ice, liquid nitrogen, or cooled aggregates.
 - Avoid placing concrete during the hottest part of the day.

Second, use good curing practices:

- Apply curing compound immediately after finishing is complete.
- Protect the concrete from significant changes in ambient temperatures. For example, if a drop in temperature is likely soon after placement (e.g., if a cold front is expected, or at night), insulate the concrete with blankets or polyethylene sheets. This will reduce heat loss from the concrete surface. It will also moderate differences in temperature throughout the depth of the slab, reducing the risk of curling.

Preventing Early-Age Cracks with Uniform Support

Edge and corner breaks due to loss of base support can be prevented by good design and detailing and by careful preparation of the subgrade and base. In particular, the base must be uniform and stable (see [Surface and Structural Performance in Chapter 2](#) and [Subgrades and Bases in Chapter 8](#)).

Testing for Cracking Risk

There are no tests that assess the risk of cracking for a given concrete mixture in a given environment. However, the risk of cracking in a given construction site can be estimated using modeling tools such as HIPERPAV (see [Crack Prediction with HIPERPAV in Chapter 8](#)). In addition, standard tests based on restrained shrinkage are available to be used to compare the relative risks of different mixture combinations during prequalification and mix design.

One type of test is based on casting concrete around an inner steel ring (i.e., ASTM C1581 and AASHTO T 334), which provides the restraint needed to determine the effects of concrete variations on cracking tendency. Concrete is cast around a steel ring, and gages on the ring measure the development of strain that begins soon after the samples are cast. This method is useful for (and limited to) determining the relative susceptibility of different concrete mixtures to early-age cracking due to drying shrinkage. Drying can be started at any required age. This is an advantage over ASTM C157, in which the first reading is taken after 24 hours. ASTM C1581 uses a smaller concrete sample and thus the results are available more quickly than by using AASHTO T 334. However, smaller aggregates must be used, so rarely can the job mix be tested directly using the ASTM method; thus, AASHTO T 334 is recommended for use in AASHTO PP 84.

Another test available in AASHTO PP 84 is the dual ring test (AASHTO TP 363). This test takes less time to run than either of the single-ring tests. The concrete is formed between two gauged invar rings (Figure 6-25), and both expansion and shrinkage stresses are monitored. After seven days, the system is cooled and the temperature at which cracking occurs is recorded.



Figure 6-25. Gauged invar rings for casting concrete to monitor both expansion and shrinkage stresses

Summary of Preventable Early-Age Cracks

Plastic Shrinkage Cracks

Time of Occurrence

These occur before set, while the concrete is plastic.

Description

- 1 to 3 ft apart (Figure 6-26)
- Usually short (a few in. to several ft long)
- Relatively shallow (1 to 2 in. deep)
- Discontinuous
- Generally perpendicular to wind direction
- May occur throughout the panel surface
- Rarely intersect the slab perimeter



Figure 6-26. Plastic shrinkage cracks

Cause

Plastic shrinkage cracks are caused when rapid evaporation of moisture from the concrete surface causes the surface to dry while the concrete is still plastic (before initial set). As the surface dries, it begins to form a crust. Shrinkage of the fast-drying surface crust is restrained by the plastic concrete underneath it, resulting in surface cracks.

Weather conditions such as the following increase surface evaporation and thus the formation of plastic shrinkage cracks:

- Low relative humidity during concrete placement
- High concrete or air temperatures

- Wind blowing across the pavement surface (at any temperature)
- A sudden cold front or rain

Note that excessive evaporation can occur in cool but windy weather conditions.

Combinations of these weather conditions will increase surface moisture evaporation and the likelihood of plastic shrinkage cracking.

Plastic shrinkage can also be exacerbated by the following:

- Delayed set of the concrete
- Dry aggregate, which absorbs moisture and thus reduces the available bleed water
- Gap-graded aggregate, which requires more paste than other aggregate types
- Too-fine sand or other fine materials such as SCMs, which reduce bleeding
- Delayed finishing, which prevents application of protective curing methods

Plastic shrinkage cracks should not be confused with pre-hardening cracks caused by concrete settlement on either side of reinforcing steel or the movement of concrete forms.

Effect

Plastic shrinkage cracks are somewhat unsightly, but they generally do not pose a structural problem unless they are very deep. However, plastic shrinkage cracks do permit water and chemicals to enter the concrete, so extensive plastic shrinkage cracking can result in long-term durability problems.

Repair

If the concrete is still plastic, plastic shrinkage cracks can be closed by re-vibrating the concrete (ACI 305.1-06 [2007]). Tight, hairline cracks do not require repair. Deep or very wide cracks should be sealed.

Prevention

When evaporation is expected to be high—i.e., when conditions are hot, windy, or sunny, and/or the humidity is low—take appropriate precautions to prevent plastic shrinkage cracking:

- Perhaps most important, protect the new concrete surface with adequate curing. Possible protective measures include the use of evaporation retarders, fogging the area over the newly placed concrete, and

the application of liquid membrane-forming curing compounds as soon as finishing is complete (see [Curing Compounds in Chapter 4](#) and [Curing in Chapter 8](#)).

- If possible, plan to place concrete during conditions that are less likely to cause shrinkage cracking. For example, during the summer, place concrete in the late afternoon, early evening, or at night when ambient temperatures are cooler and relative humidity is higher.
- Cool the concrete mixture.
- Reduce absorption of mix water by the aggregate (see [Stockpile Management](#) and [Batching](#) under [Concrete Production in Chapter 8](#)).
- Dampen dry, absorptive subgrade.
- Finish the concrete surface promptly, then apply curing early.
- Some bleeding of the concrete may help reduce the rate of surface moisture loss, but do not design a mixture to bleed excessively simply to avoid plastic shrinkage cracking.

Map Cracking (Crazing)

Time of Occurrence

This occurs after concrete has set; it is usually apparent the day after placement or by the end of the first week.

Description

- Network of fine fissures on the concrete surface that enclose small ($\frac{1}{2}$ to $\frac{3}{8}$ in.) and irregular hexagonal areas (Figure 6-27)
- Shallow; often only $\frac{1}{8}$ in. deep
- May occur throughout the panel surface



Larry Sutter, used with permission

Figure 6-27. Map cracking

Cause

Map cracking generally occurs on hand pours with significant hand finishing and/or inadequate curing. This type of cracking is caused by restrained drying shrinkage of the surface layer after set. It is often associated with the following:

- Overfinishing the new surface or finishing while there is bleed water on the surface
- Mixes with high w/cm ratios (mixes that are too wet)
- Late or inadequate curing
- Spraying water on the surface during finishing
- Sprinkling cement on the surface to dry bleed water

Effect

Some map cracking cannot be seen unless the pavement surface is wet. Visible crazing is somewhat unsightly but generally does not pose a structural problem. However, map cracks do permit water and chemicals to enter the concrete surface, so extensive map cracking may accelerate long-term durability problems.

Prevention

Take appropriate precautions to prevent map cracking:

- Use moderate slump mixtures (generally, with a low w/cm ratio). Higher slump mixtures may be acceptable if they do not produce excessive bleeding. Bleeding can be controlled by using water-reducing admixtures in the mix.
- Do not spray water on the slab to facilitate finishing.
- Do not finish the surface while bleed water is present, and do not sprinkle dry cement on the surface to dry the bleed water.
- Do not overwork or overfinish the surface.
- Begin curing as soon as possible. Cover the surface thoroughly with curing compound.
- Use wet curing methods, i.e., fog spraying and/or wet burlap, and keep the surface moist for at least three days.

Repair

Map cracks generally do not require repair. To improve aesthetics, they may be removed by diamond grinding the surface.

Random Transverse Cracks

Time of Occurrence

These occur after concrete has set, but before the pavement is opened to traffic.

Description

- Perpendicular to centerline (Figure 6-28)
- Usually evenly spaced and continuous from the centerline to the edge of the pavement
- May fork into a Y shape
- Extend into the full depth of slab
- May be hairline (and nearly invisible) or open
- Normally appear within the first 72 hours



Jim Grove, ATI Inc./FHWA, used with permission

Figure 6-28. Random transverse crack

Cause

Random transverse cracking occurs after the concrete sets but before it has gained enough strength to resist tensile stresses. The stresses are generally caused by restrained, cumulative shrinkage of the slab and by curling and warping (see the [Temperature Effects](#) and [Shrinkage](#) sections earlier in this chapter). Stress may be increased by the following factors:

- Early drying
- High-shrinkage mixes
- High setting temperature, which increases the amount of cooling after set
- Dry aggregate, which absorbs moisture and thus increases shrinkage

- Gap-graded aggregate, which requires more paste
- Early loads from construction equipment
- Change in weather that increases shrinkage

Effect

In jointed pavements without continuous reinforcement (the majority of concrete pavements), random transverse cracks can permit water and chemicals to enter the concrete, resulting in long-term durability problems. “Working” transverse cracks (that is, cracks in which vertical movement or displacement along the cracks is detectable) can cause structural failure.

Random transverse cracks do not cause problems in unjointed CRCPs. The reinforcing steel causes cracks to develop within an acceptable spacing and holds the cracks tightly together. These tight cracks do not diminish the pavement’s initial structural performance and do not allow the infiltration of aggressive fluids and other materials.

Prevention

To prevent random transverse cracking in unreinforced concrete, use the following good practices:

- Minimize drying shrinkage by using a mix with a low paste content.
- Maximize the size and amount of coarse aggregate while leaving a workable mix.
- Keep aggregate piles moist.
- Wet the grade prior to paving.
- Minimize the temperature at which concrete sets to minimize the amount of cooling (and thermal contraction) after final set. Generally, this involves controlling the heat of hydration through careful selection of cementitious materials, using precooled materials in the mixture, etc. ([see Temperature Effects earlier in this chapter](#)).
- Make sure the joints are constructed at the proper time, spacing, and depth.
- Protect the concrete surface from sudden temperature changes, from moisture loss, and from excessive curling and warping through proper curing ([see Curing Compounds in Chapter 4](#) and [Curing in Chapter 8](#)).
- Keep construction traffic off the pavement as long as possible.

Control

A certain amount of full-depth cracking to relieve tensile stresses is inevitable in concrete pavements. In unreinforced concrete, the number and location of these random cracks can be controlled with contraction joints.

Construct contraction joints to create planes of weakness where cracks will form and thus relieve stresses. To completely control these cracks, joints must be cut at the proper time, the proper depth, and the proper spacing (see [Joint Sawing in Chapter 8](#)).

Repair

Random transverse cracks that are not working (that is, cracks in which there is no detectable vertical movement or displacement along the cracks) should be sawed and sealed. However, random transverse cracks that are working or near a joint or another crack generally require a full-depth repair to prevent structural failure. Dowel bar retrofit can be considered for some cracks.

Random Longitudinal Cracks

Time of Occurrence

These occur after concrete has set but before the pavement is opened to traffic.

Description

- Parallel to centerline (Figure 6-29)
- Run through the full depth of the slab
- May be hairline (and nearly invisible) or open
- May appear within the first 24 hours or after several months



ACPA, used with permission

Figure 6-29. Random longitudinal crack

The causes, effects, control, prevention, and repairs for random longitudinal cracks are similar to those for random transverse cracks. The following additional information is specific to longitudinal cracks.

Cause

Random longitudinal cracking can occur after the concrete sets but before it has gained enough strength to resist tensile stresses. The stresses are generally caused by restrained, cumulative shrinkage of the slab and by curling and warping (see the [Temperature Effects](#) and [Shrinkage](#) sections earlier in this chapter).

The stress of restrained thermal contraction and drying shrinkage may be increased by the following factors:

- Nonuniform base support caused by frost heaving, soil setting, or expansive soils
- A slab that is too wide, i.e., longitudinal joints that are too far apart
- Restraint from an adjoining tied slab
- A joint cut that is too shallow

Control

If more than one lane width of unreinforced concrete is placed at once, cut or form longitudinal joints between lanes where cracks will form (see [Joint Sawing in Chapter 8](#)).

Prevention

Use the same good practices as for preventing random transverse cracking, as listed earlier. In addition, take care to do the following:

- Place concrete on a stable, uniform base not prone to frost heaving, settling, or expansion.
- Prevent early loading by keeping construction equipment off the pavement, particularly along the free slab edges.
- Do not tie too many lanes together with tiebars.
- Tie lanes together when the weather is not too hot or too cold (extreme temperatures will increase contraction).
- If the slab is 9 in. thick or less, the slab width should be no more than 12 ft wide without a longitudinal joint. If the slab is 10 in. thick or more, the slab should typically be no wider than 13 ft without a longitudinal joint.

Corner Breaks

Time of Occurrence

Corner breaks can occur after set, before pavement is opened to the public. However, corner breaks can continue to form for years, anytime the pavement loses support due to soil settling, erosion, frost heaving, expansive soils, or excessive curling and warping.

Description

- Cracks intersecting the adjacent transverse and longitudinal joints at approximately a 45° angle (Figure 6-30)
- From 1 ft long to half the slab width on each side
- Full depth



Figure 6-30. Corner break

Cause

Corner cracks occur when a pavement carries loads that are heavier than its current strength can support and/or when there is loss of base support. For instance, early loading with heavy construction equipment can cause corner cracking.

Furthermore, curled or warped slabs lose base support where the slab lifts away from the grade. When loads are applied, the pavement will crack in the areas that have reduced support.

If the base is not uniform, the slab will similarly lose support where the base is less stable than in the surrounding areas.

Repeated loadings may also create voids under slab corners, and, when loads are applied, the pavement may crack where the support is weakened.

Effect

Corner cracks usually represent structural failures.

Prevention

To prevent corners cracking, consider the following measures:

- Make sure the base is uniformly stable over time
- Keep construction traffic off the new pavement as long as possible
- Properly cure the concrete as long as possible to help prevent or reduce curling and warping

Repair

Corner cracks generally require full-depth repair of the slab and perhaps stabilization of the base.

Durability Related Properties

Concrete Durability Is Affected by Many Concrete Properties

The rest of this chapter discusses concrete properties that can affect concrete durability.

Durability is concrete's ability to resist chemical and environmental attack while in service. It is a critical characteristic of long-life pavements but, in itself, is not generally considered a property of concrete.

Durability is environment specific; that is, a concrete pavement that is durable in a non-freeze-thaw environment and not exposed to chemical deicers might not be durable in a freeze-thaw environment in which deicers are commonly used. Therefore, concrete properties that contribute to durable concrete may include any (but not necessarily all) of the following:

- Low permeability
- Frost resistance
- Sulfate resistance
- Low alkali-silica sensitivity
- Abrasion resistance

Note that concrete strength is not necessarily a good measure of potential durability.

Transport (Permeability)

Key Points

- Concrete durability is improved by enhancing concrete's ability to prevent fluids from penetrating, that is, by reducing concrete permeability.
- Permeability is reduced by reducing cracking, reducing the number of connected pores in the paste system, and improving the interface between the paste and aggregate.
- Therefore, permeability can be reduced by reducing the w/cm ratio, increasing the degree of hydration, using SCMs, and using good curing practices.
- Strength is not a good measure of potential permeability.
- Testing methods include ASTM C1202/AASHTO T 277, ASTM C1585, and AASHTO T 358.

Simple Definition

Permeability is the ease with which fluids can penetrate concrete. (Permeability is different from porosity, which is a measure of the number of [possibly disconnected] voids in concrete.)

Significance of Permeability

Almost all durability-related distresses in pavements can be slowed or stopped by reducing the ability of fluids (including solutions) to penetrate the system. This is because most durability-related distress mechanisms involve the transport of harmful substances into the concrete:

- Water that expands on freezing, leaches calcium hydroxide, and/or carries dissolved ions that attack the concrete
- Salts that crystallize on wetting and drying or exert osmotic pressure during freezing and thawing, causing surface damage
- Salts that react with cement hydration products to form expansive compounds, such as calcium oxychloride

- Alkalis in solution facilitating alkali-aggregate reactions
- Sulfates that attack the aluminate compounds
- Carbon dioxide that reduces the alkalinity (pH)
- Oxygen and moisture that contribute to the corrosion of steel bars or reinforcement
- Chlorides that promote corrosion of embedded steel

Factors Affecting Permeability

Permeability is primarily controlled by the paste system in concrete and the quality of the interfacial zone between the paste and the aggregate. If there is a large number of pores and they are connected (percolated), the concrete will be permeable. Reducing the porosity and the likelihood that pores will be connected is key to achieving low permeability (Detwiler 2005). The following activities will help:

- Reduce the w/cm ratio as low as is consistent with other requirements of the concrete, including cracking
- Use appropriate SCMs
- Ensure adequate consolidation and curing
- Minimize cracking

Testing

Three tests are finding acceptance as indicators of the transport properties of a mixture.

The rapid chloride penetrability test (ASTM C1202/AASHTO T 277) has been in use for some time. The test does not measure permeability directly but measures conductivity, based on the premise that charge is more readily transmitted through fluids in pores than through solid hydration products or aggregate.

Two resistivity tests (AASHTO T 358 and TP 119) (Figure 6-31) have more recently been adopted that can be conducted more efficiently than the rapid chloride penetrability test.

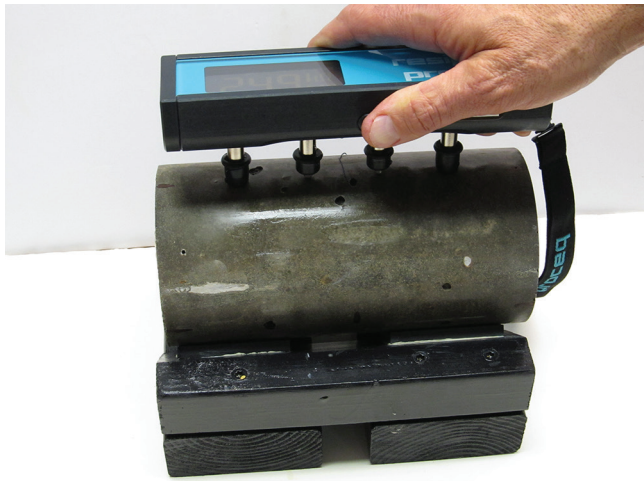

Figure 6-31. Wenner resistivity test

Both approaches are sensitive to sample geometry, test temperature, degree of saturation, and how the sample was stored (Spragg et al. 2012, Weiss 2014). To address these limitations, work is underway to normalize the results of all electrical tests through the formation factor (F-factor), which is directly related to the concrete pore

volume and connectivity as well as the conductivity of the pore solution (Table 6-4) (Weiss 2014).

The F-factor can be used to characterize the pore structure of concrete because it is a value that is only dependent on the pore geometry and connectivity. The F-factor is defined as the ratio of the resistivity of a bulk body (ρ) and the resistivity of the pore solution in the body (ρ_o), as shown in Equation 6.3.

$$F = \frac{\rho(\Omega \cdot m)}{\rho_o(\Omega \cdot m)} \tag{6.3}$$

ASTM C1585 is an absorption test in which the rate of water absorbed into a conditioned thin concrete sample is measured over a period of time. The rate of water absorption ($\text{mm}/\text{s}^{1/2}$) is defined as the slope of a best fit line of I (based on mass of water absorbed) plotted against the square root of time ($\text{s}^{1/2}$). The slope typically makes a distinctive change at some point, thus defining initial absorption and secondary absorption. This is illustrated in Figure 6-32.

Table 6-4. Relationship between AASHTO T 277 (ASTM C1202) results, resistivity, and the F-factor, assuming a pore solution resistivity of $0.1 \Omega \times \text{m}$

ASTM C1202 Classification	Charge Passed (Coulombs)	Resistivity ($\text{k}\Omega \times \text{cm}$)*	Formation Factor
High	>4,000	<5.2	520
Moderate	2,000–4,000	5.2–10.4	520–1,040
Low	1,000–2,000	10.4–20.8	1,040–2,080
Very low	100–1,000	20.8–207	2,080–20,700
Negligible	<100	>207	20,700

* Calculated using first principles

Source: Based on Spragg et al. 2012

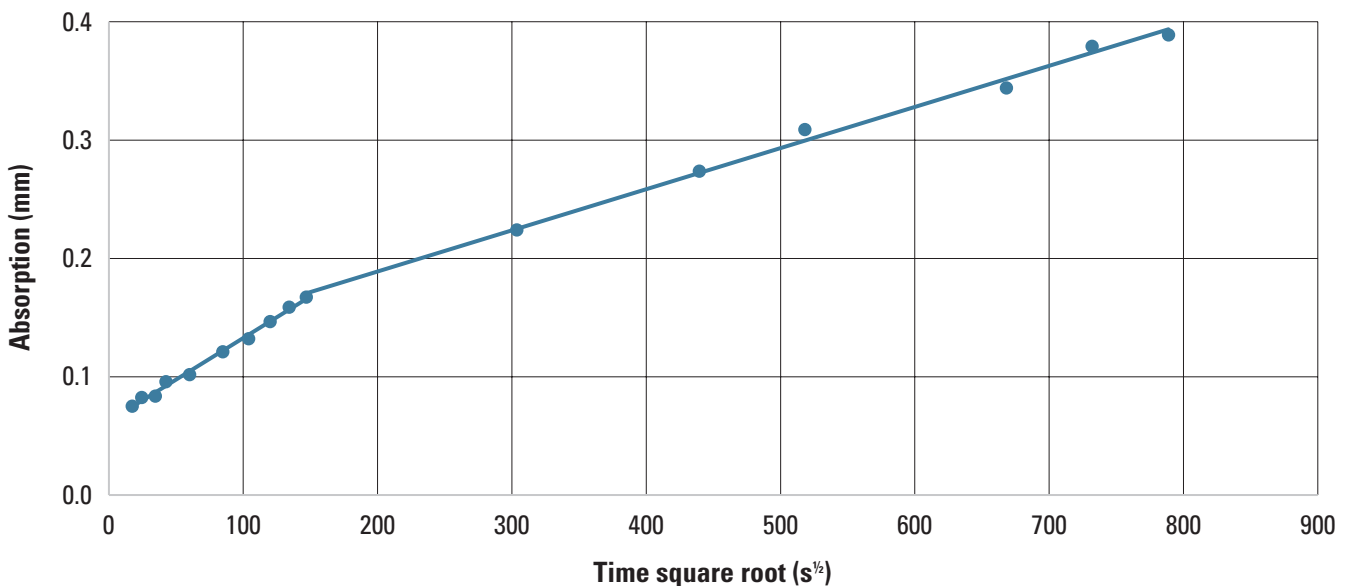

Figure 6-32. Illustration of initial and secondary absorption

The degree of saturation, defined as the ratio of the absolute volume of absorbed water to the total volume of water-accessible pores, can be calculated from the absorption test. The degree of saturation at the intersection between the initial and secondary absorption is related to the point at which the capillary pore system becomes saturated, which may be correlated with freeze-thaw deterioration (Weiss 2014).

Resistance to Freezing and Thawing

Key Points

- Problems related to low frost resistance include freeze-thaw damage, chemical attack by salts, salt scaling, D-cracking, and popouts.
- Concrete resistance to cold weather can be improved through several good practices:
 - Maintaining a proper air-void system to provide space for freezing and expanding water to move into
 - Incorporating an appropriate amount of SCMs
 - Using a suitable w/cm ratio
 - Using sound aggregate
 - Paying careful attention to good mixing, placement, and curing practices
 - Protecting concrete so that it gains sufficient strength and dries before it is exposed to freezing temperatures or deicing salts
 - Considering the use of penetrating sealers to reduce fluid penetration
- Test methods include the following:
 - Aggregates: ASTM C666/AASHTO T 161, ASTM C88/AASHTO T 104, Iowa Pore Index Test
 - Air-void system: ASTM C231/AASHTO T 152, ASTM C173/AASHTO T 196, ASTM C138/AASHTO T 121, ASTM C457, AASHTO TP 118
 - Freeze-thaw: ASTM C666
 - Salt scaling: ASTM C672

Simple Definition

Freeze-thaw resistance is a concrete's ability to resist damage during winter weather.

Significance of Resistance to Freezing and Thawing

Concrete that is exposed to freezing and thawing can experience several kinds of damage: freeze-thaw damage, chemical attack by salts, salt scaling, D-cracking, and popouts.

- Freeze-thaw damage to the paste is due to the expansion of water in the capillary pores as it freezes, causing cracking that can be as deep as several inches into the concrete. Cycles of freezing and thawing can eventually cause severe surface loss (Figure 6-33).
- Some deicing chemicals can react with cement hydration products to form expansive oxychloride compounds and cause deterioration of joints.
- Deicing chemicals can aggravate freeze-thaw damage and cause cracking, scaling, and disintegration.
- When certain aggregates with a critical pore size are saturated, they expand and fracture when the water freezes, causing D-cracking and/or popouts.



Figure 6-33. Joint damage showing flakes

Freezing and Thawing Damage

Water expands about 9 percent when it freezes, potentially setting up tensile stresses in the paste unless there are open spaces for the water to move into. Freezing also results in changes in the pore solution chemistry that can result in the generation of stress within the concrete due to osmotic forces (Powers 1945, Powers 1954, Powers 1955, Powers and Helmuth 1956, Marchand et al. 1995, Penttala 1998, Scherer and Valenza 2005).

If more than about 85 percent of the voids (including air voids) are filled with water, damage is incurred rapidly (Jones et al. 2013, Newlon and Mitchell 1994, Janssen and Snyder 1994, Cordon 1966).

Some chemical deicers are hygroscopic, meaning that they will absorb water from the atmosphere at ambient temperatures. They will therefore never dry out and will increase the saturation of concrete in contact with them (Spragg et al. 2015). This is particularly noticeable in joints in which such solutions tend to collect and are not easily washed out.

Oxychloride Formation

Some chemical deicers, predominately those based on magnesium chloride (MgCl₂) or calcium chloride (CaCl₂), can negatively impact concrete durability (Sutter et al. 2008, Weiss and Farnam 2015). Calcium chloride will react with the calcium hydroxide reaction product from cement hydration to form expansive calcium oxychloride (Equation 6.4).

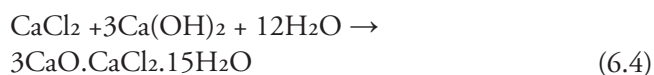

MgCl₂ goes through a two-step process, first reacting with calcium hydroxide to form brucite and CaCl₂ (Equation 6.5), which in turn reacts with more hydroxide to form more oxychloride.



The expansion is about three times that of freezing water, thus incurring more damage (Equation 6.6).

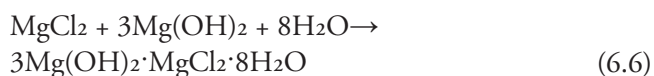

Depending on the concentration of salt in the solution, the change to calcium oxychloride occurs at temperatures between 32°F and 122°F (Weiss and Farnam 2015)—i.e., above freezing. The oxychloride compound is unstable at room temperature, making it a challenge to identify in samples examined in laboratory conditions.

The resulting pavement distress may first appear as “shadowing” at the pavement joints, which progresses into formation of flakes or cracks around aggregate particles and eventually disintegration of the concrete, as shown in Figure 6-34.

As salt concentration increases, this mechanism becomes critical. Deicers are applied at concentrations well in excess of what is needed for the calcium oxychloride phase change to occur. When these solutions are used in anti-icing operations (applied prior to but in anticipation of a precipitation event), they remain at full concentration until becoming diluted as the precipitation event occurs.



Figure 6-34. Joint damage

Salt Scaling

Scaling (Figure 6-35) is a physical deterioration mechanism aggravated by the use of deicing salts and freezing and thawing. Salts used to melt snow and ice go into solution and penetrate concrete’s pore structure; subsequently, the salts may crystallize upon drying, creating expansive pressures in the microstructure. In addition, as the water freezes to ice, the salts are concentrated at the freezing site.

Unfrozen water migrates toward the site due to osmosis (the tendency for imbalances in salt concentrations to seek balance). These osmotic pressures also cause cracking, scaling, and disintegration.



Figure 6-35. Scaling

Another mechanism discussed in the literature is that of glue spalling. A layer of ice may form and bond with the surface of the concrete. As temperatures fall, the ice contracts more than the concrete, pulling the concrete with it, thus setting up shallow cracks near the surface of the concrete.

Research has shown that relatively low concentrations of sodium chloride (2 to 4 percent) cause greater damage than greater concentrations of sodium chloride (Klieger 1957).

Another factor contributing to scaling is that if a surface is finished (especially floated) before bleeding has ended, then bleed water may be trapped below the surface, either setting up lenses that will break under traffic or significantly increasing the w/cm ratio at the surface.

Methods to control deicer scaling are as follows:

- Ensure that the concrete has a proper air-void system
- Ensure that finishing activities are carried out only after bleeding has ended
- Delay salt applications until the concrete is mature (preferably several months)

D-Cracking

D-cracking is damage that occurs in concrete due to expansive freezing of water in some calcareous aggregate particles (see [Aggregate Durability in Chapter 4](#)). The risk is most marked in aggregates that have an average pore size such that water is readily absorbed (increasing saturation) but is difficult to dry out because of surface tension with the pore walls.

The damage normally starts near joints to form a characteristic D-shaped crack (Figure 6-36).



Figure 6-36. D-cracking

This problem can be reduced by selecting aggregates that are less susceptible to freeze-thaw deterioration. Where marginal aggregates must be used, reducing the maximum aggregate size will delay when damage becomes significant. Providing drainage for carrying water away from the base may prevent saturation of the pavement.

Popouts

A popout is a conical fragment that breaks out of the surface of concrete, leaving a shallow, typically conical, depression (see [Figure 4-12 in Chapter 4](#)). Generally, a fractured aggregate particle will be found at the bottom of the hole. Unless numerous, popouts are considered a cosmetic detraction and do not generally affect the service life of the concrete.

Aggregates containing appreciable amounts of shale or other shaly rocks, soft and porous materials (clay lumps for example), and certain types of chert have low resistance to weathering and should be avoided (see [Aggregate Durability in Chapter 4](#)). Weak, porous particles in the aggregate can be reduced by various methods of aggregate beneficiation, such as jigging, heavy-media separation, or belt picking.

Factors Affecting Resistance to Freezing and Thawing

Many factors influence the resistance of concrete to frost-related damage, each of which is discussed briefly below. Damage due to freezing of critically saturated concrete can be delayed by ensuring that the concrete has an adequate air-void system. In addition, a reduced w/cm ratio and inclusion of sufficient SCMs will help to slow fluid penetration, as well as resist oxychloride formation.

Air-Void System

Concrete's susceptibility to freeze-thaw damage may be reduced by entraining a number of small, closely spaced air bubbles in the paste (see [Function of Air Entrainment in Concrete in Chapter 4](#)). The air voids provide space for freezing, expanding water in the pores to move into, thus relieving the pressure (Mielenz et al. 1958). They also delay the time at which critical saturation will be reached (Li et al. 2017).

Powers (1949) introduced the concept of a spacing factor, which indicates the distance water must travel to reach an air void. It is generally accepted that a spacing factor of 0.008 in. or less will be adequate to protect concrete (Mielenz et al. 1958, ACI 201.2R-16, ACI 318-14). For a given air content, small, closely spaced air voids provide better protection than larger, more distant voids (Klieger 1994).

The amount of air, as well as the size and spacing of the voids, are influenced by the following factors (Whiting and Nagi 1998):

- **Type and Dosage of Air Entrainer:** Non-Vinsol resin admixtures produce smaller air bubbles than traditional admixtures. Air-entraining admixtures are also available formulated specifically for low-slump mixtures like those used for paving. Increasing the dosage will increase the total air content of a mixture.
- **Grading and Amount of Aggregate:** Air is most easily entrained in concrete that contains increasing amounts of sand in the #100 to #30 sieve range. Increasing the total aggregate in the concrete means that there is less paste that has to be protected with entrained air.
- **Chemical Composition of the Cementitious Materials:** More alkalis in the cement will result in more entrained air. High loss-on-ignition (LOI) fly ash (that is, loss of mass when heated to 1,830°F) will require greater dosages of admixture to achieve the same air content. Variable LOI in a fly ash source may cause large variations in the concrete air content. Such a fly ash should be monitored using the foam index test with every delivery to prevent problems in the batch plant.

- **Fineness and Amount of Cementitious Materials:** Mixtures with finer cement and increasing cement content will require a higher dosage of admixture to achieve the same air content.
- **Chemical Characteristics of Water and Water-Reducing or Retarding Admixtures:** Other admixtures may interfere with the air-entraining admixture (AEA). This has been found to be especially true for water-reducing admixtures based on polycarboxylates. Possible incompatibilities should be evaluated in trial batches early in the selection of materials and proportions.
- **Water/Cementitious Materials Ratio and Slump of the Concrete:** A higher w/cm ratio means that there is more free water in the mixture, which assists air entrainment. It is easier to entrain air in a high-slump mixture than in a low-slump mixture.
- **Type of Plant and Production Procedures:** This includes the sequence of materials addition, mixer capacity, and mixing time and speed. The later the AEA is added to the mixture, the less entrained air there will be. Depending on the type of mixture, the nominal suggested mix time is approximately 60 seconds (Cable and McDaniel 1998). Some mixtures lose air during transport from the plant to the site and during placement. Therefore, it is recommended that air be checked before and after placement to ensure that the target air content is met.
- **Temperature of the Concrete and Construction Practices:** These include transport, delivery, and retempering, as well as placement, consolidation, and finishing. Higher temperatures require more AEA to achieve the same air content. Late addition of water to a mixture will cause the air content to increase and possibly exacerbate air-void clustering. Handling of the concrete after initial mixing will tend to reduce the air content.

Aggregates

Aggregates should be selected that are resistant to freeze-thaw damage. This can be determined from records of the performance of the aggregate in the past or by testing, as discussed below.

Cementitious Materials

Where CaCl₂- and MgCl₂-based deicers are likely to be used, sufficient dosage of fly ash or slag cement is required to reduce the calcium hydroxide content of the hydrated cement paste and thus prevent calcium oxychloride formation. Current data are indicating that about 30 to 35 percent of SCMs is required to keep calcium oxychloride to a manageable level.

Concrete containing SCMs can be expected to exhibit good scaling resistance if the concrete is properly designed, placed, and cured. Whereas, ACI 318 limits the amount of pozzolans or GGBF slag (maximum 25 percent fly ash, 50 percent slag, and 10 percent silica fume) in concrete to minimize deicer scaling, ACI 201.2R-16 recommends not applying these limits for machine-placed concrete. Higher dosages of SCMs can be used if adequate durability is demonstrated by testing and/or field performance.

Finishing

Concrete surfaces should be finished after the disappearance of the bleed water (Kosmatka and Wilson 2016). Working bleed water into concrete weakens the top surface and can cause a crust to form with water accumulation underneath, which could easily scale off. Overfinishing should be avoided because it may cause loss of air at the surface. Water should never be applied to the surface to facilitate finishing.

Curing

Good curing practices ensure that hydration reactions progress and that cracking is minimized, enabling the desired properties and performance (ACI 308R-16). Liquid membrane-forming curing compounds are widely and successfully used on pavements, provided that the proper curing material is applied in the right amount as the water sheen disappears. In cold weather, insulating blankets or multiple layers of burlap or straw can be used to maintain the favorable temperature for hydration and to minimize temperature differentials.

Testing

Air-Void System

The most common test procedure to determine the air content is the pressure method, ASTM C231/AASHTO T 152 (see [Air Content \[Plastic Concrete, Pressure Method\] in Chapter 9](#)). Air in the fresh concrete and the aggregates is measured. It is applicable to dense, normal-weight aggregates with the appropriate aggregate correction factor. Another test method applicable to dense, cellular, or lightweight aggregate is the volumetric method (Rollameter), ASTM C173/AASHTO T 196. The volumetric method takes longer to complete and is more physically demanding; therefore, it is not widely used for concrete with normal-weight aggregates. The air content of the freshly mixed concrete can also be determined by the gravimetric method, ASTM C138/AASHTO T 121.

These methods determine the total air content. However, for satisfactory frost resistance, an air-void

system with closely spaced small bubbles is needed. The average size of the bubbles and their spacing is characterized by the specific surface and the spacing factor. These parameters must be determined on hardened concrete (ASTM C457); although, the air-void analyzer will provide these parameters in fresh concrete. Unfortunately, it is not field friendly and therefore not commonly used.

To address the shortcoming inherent in only measuring total air content, an alternative method has been developed called the super air meter (SAM). The SAM method has been standardized under AASHTO TP 118, *Provisional Standard Method of Test for Characterization of the Air-Void System of Freshly Mixed Concrete by the Sequential Pressure Method*. It is a modified version of an AASHTO T 152 pressure meter (Welchel 2014), but instead of using a single testing pressure, as is used in T 152, the SAM uses sequential pressures to not only determine the volume of total air but also to make an inference regarding the quality of the air-void system with a term called the SAM number.

The SAM number has been correlated to the air-void spacing factor obtained through ASTM C457 and the durability factor (DF) of concrete as assessed in AASHTO T 161. Figure 6-37 is a plot of the SAM number versus the T 161 DF, with dashed lines showing common failure criteria (70 percent for the DF).

Results suggest that the SAM number has a better correlation with results from T 161 than it does to the ASTM C457 spacing factor. Furthermore, round robin testing has shown that the variation in the SAM test is similar to variation in ASTM C457 and ASTM C666 (Ley et al. 2017).

According to AASHTO PP 84, in addition to a SAM number of 0.2, an air content of at least 4 percent should be provided in the concrete. This value was chosen to ensure some minimum air content was included in the concrete mixture. Air contents as low as 3 percent have shown freeze–thaw durability in ASTM C666 (Ley et al. 2017). However, some safety factor was needed, so 4 percent was chosen.

The gravimetric method for determining unit weight (ASTM C138/AASHTO T 121) also gives an indication of air content, provided the specific gravities of other ingredients are known. The method is especially helpful for determining when something has gone wrong with the air system because significant changes in the unit weight would signal a change in the mixture's air or water content.

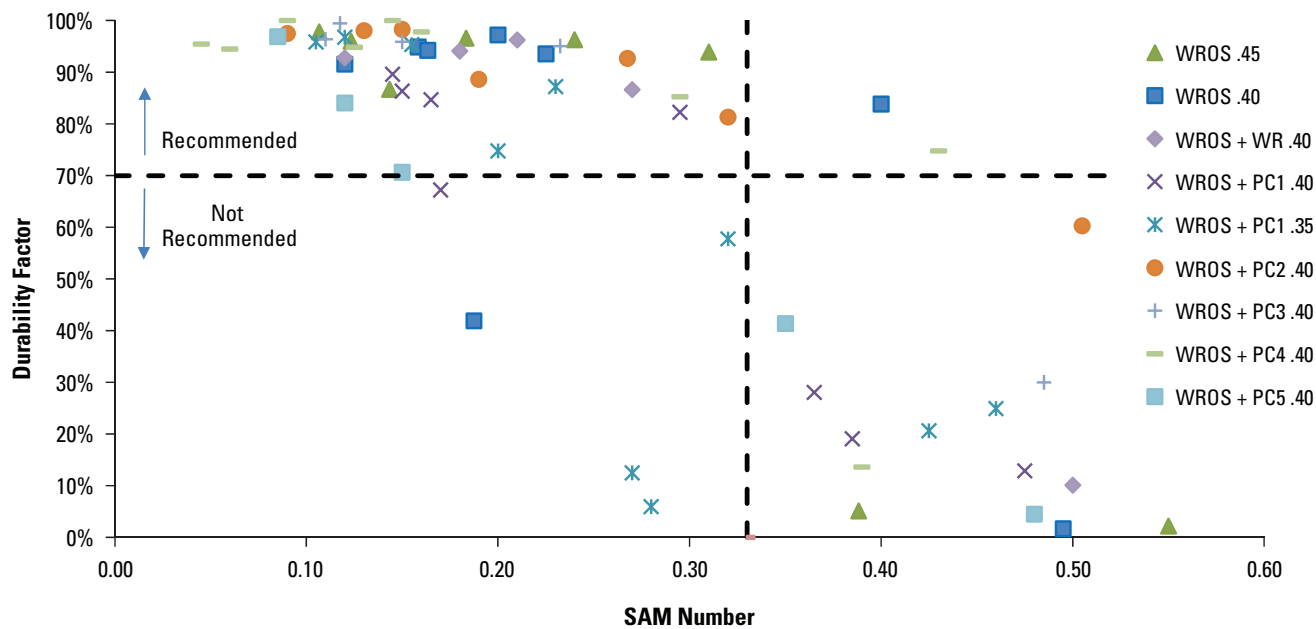

Ley et al. 2017, published by Elsevier Ltd., used with permission from Elsevier

Figure 6-37. Correlation between SAM number and freeze-thaw performance

The air content of concrete is generally measured before it reaches the paver. However, measurement of the air-void system after placement and vibration would provide more useful information. Some reduction in air is expected as it is vibrated; however, this loss does not necessarily imply that freeze-thaw protection is compromised.

ASTM C457 has two microscopical procedures for determining the air-void parameters in lapped sections of hardened concrete samples: the linear traverse method and the modified point count method, the former being the most widely used (see Air Content [Hardened Concrete] in Chapter 9). Some states are using image analysis techniques to determine air content of lapped sections of hardened concrete samples; these procedures are now included as part of ASTM C457.

Time to Saturation

When an unsaturated concrete is exposed to a fluid on one side, the fluid is first absorbed into the smallest pores, which include the gel pores and capillary pores. The wetting front progresses through the sample, saturating these small pores while bypassing the larger entrained and entrapped air voids. The rate of absorption is relatively fast at this stage, and it normally takes about 10 to 18 hrs to occur when the fluid is water under standard test conditions. As fluid continues to be adsorbed, albeit far more slowly, the larger entrained and entrapped air voids become progressively filled until complete saturation occurs. This can take months to years (Todak et al. 2015).

The time to saturation of a given mixture can also be assessed using a soaking test (ASTM C1585). The results of this test can be used to estimate a time to saturation. AASHTO PP 84 sets the desired time to saturation at 30 years or longer.

Rapid Freezing and Thawing

Resistance to freezing and thawing of a concrete is normally determined using the procedures (A or B) described in ASTM C666. Procedure A involves rapid freezing and thawing of samples of concrete in water. Procedure B requires rapid freezing in air and thawing in water.

The fundamental transverse frequency of the samples is measured periodically and used to determine the relative dynamic modulus of elasticity, from which a DF is calculated (ASTM C666). As damage increases in the sample, the dynamic modulus will decrease. For adequate performance, specimens tested to 300 cycles are expected to exhibit a DF of 60 or more. Length change and mass loss can also be monitored.

Procedure A is the more severe test. Concretes performing well in this test have done well in field applications. Concretes failing the test may also have satisfactory field performance, but such performance must be proved in the field. Procedure B is not as severe as Procedure A, since the specimens are allowed to dry during testing.

Salt Scaling

Resistance to salt scaling is determined using the ASTM C672 test. Specimens are moist cured for 14 days and air dried for an additional 14 days. A dike is placed around the top surface of the specimens, and the surface of the concrete is covered with 4 percent calcium chloride solution. The specimens are placed in a freezing environment for 16 to 18 hours and then thawed in laboratory air for 6 to 8 hours. The surface is flushed at the end of each five cycles and a visual examination is made. The solution is replaced and the test is repeated for 50 cycles. Concretes with a rating of 3 or less are considered satisfactory. (A rating of 3 indicates moderate scaling with some coarse aggregate showing.) Some states also monitor the mass loss of the samples and require a value of less than 0.3 lb/ft² after 50 cycles.

This test is also considered to be severe, with concretes performing satisfactorily in the field despite failing ASTM C672. The Bureau De Normalisation du Québec published an alternative method that was reportedly less severe and correlated better with field performance (BNQ NQ 2621-900). This method sets out slightly different finishing and curing requirements for the samples.

Deicing Chemicals

If CaCl₂ or MgCl₂ are to be used, the mixture should be resistant to the formation of calcium oxychloride. To provide resistance, the calcium oxychloride should be determined to be less than 0.5 oz CAOXY/3.5 oz cementitious paste as determined using AASHTO T 365.

This test method is based on a low-temperature differential scanning calorimeter (LT-DSC) to evaluate the potential reactivity of hydrated cement paste and a salt solution by measuring the heat associated with calcium oxychloride formation (Weiss and Farnam 2015, Monical et al. 2015). This method provides a means for optimizing the composition of the cementitious materials by reducing the potential for formation of calcium oxychloride. Specific portland cement and SCM systems can be tested, making this a practical screening tool for selecting materials for use under anticipated deicing conditions.

D-Cracking

The performance of aggregates under exposure to freezing and thawing can be evaluated in two ways: past performance in the field and laboratory freeze-thaw tests of concrete specimens. If aggregates from the same source have previously given satisfactory service when used in concrete under similar conditions, they generally may be considered acceptable.

Aggregates not having a service record can be tested in freezing and thawing tests such as ASTM C666, using mixtures prepared in accordance with ASTM C1646. In these tests, air-entrained concrete specimens made with the aggregate in question are alternately frozen and thawed in water (Procedure A) or frozen in air and thawed in water (Procedure B). Deterioration is measured by the reduction in the dynamic modulus of elasticity, linear expansion, and weight loss of the specimens. An expansion failure criterion of 0.035 percent in 350 freeze-thaw cycles or less is used by a number of state departments of transportation (DOTs) to help indicate whether an aggregate is susceptible to D-cracking. Different aggregate types may require different criteria (Vogler and Grove 1989).

Another test for determining the freeze-thaw potential of carbonate aggregates is the Iowa pore index test. The apparatus measures the large or primary pores and the secondary or capillary pore system. Aggregates with large primary pores correlate to good durability; whereas, those with large secondary pores correlate to poor durability. Studies that correlate pore index results with durability tests indicate that the Iowa pore index test can quickly and accurately determine aggregate durability.

Sulfate Resistance

Key Points

- Sulfates damage concrete by reacting with products of hydrated C₃A in hardened cement paste and by infiltrating and depositing salts. The resulting expansive crystals damage the cement paste, causing cracking.
- Sulfate problems are more severe where concrete is exposed to wet and dry cycles than where it is continuously wet.
- Concrete can be designed to resist sulfate attack:
 - Achieve low permeability (see [Transport \[Permeability\]](#) earlier in this chapter).
 - Use a mixture with a low w/cm ratio, sulfate-resistant cements, and proper proportions of suitable SCMs.
- Testing specifications: ASTM C452 and ASTM C1012.

Simple Definition

Sulfate resistance is concrete's ability to resist attack by, and damage from, sulfates penetrating from outside the concrete system.

Significance of Sulfate Resistance

Excessive amounts of sulfates in soil or water can, over a period of years, attack and destroy concrete pavements and other structures (Figure 6-38).

Sulfates damage concrete by reacting with hydrated C₃A compounds in the hardened cement paste and by infiltrating and depositing salts. Because of crystal growth pressure, these expansive reactions can disrupt the cement paste, resulting in cracking and disintegration of the concrete.

Preventive measures are well accepted, and concrete can be designed to resist sulfate attack. This is done primarily by reducing permeability and reducing the amount of reactive elements in the concrete system needed for expansive sulfate reactions.

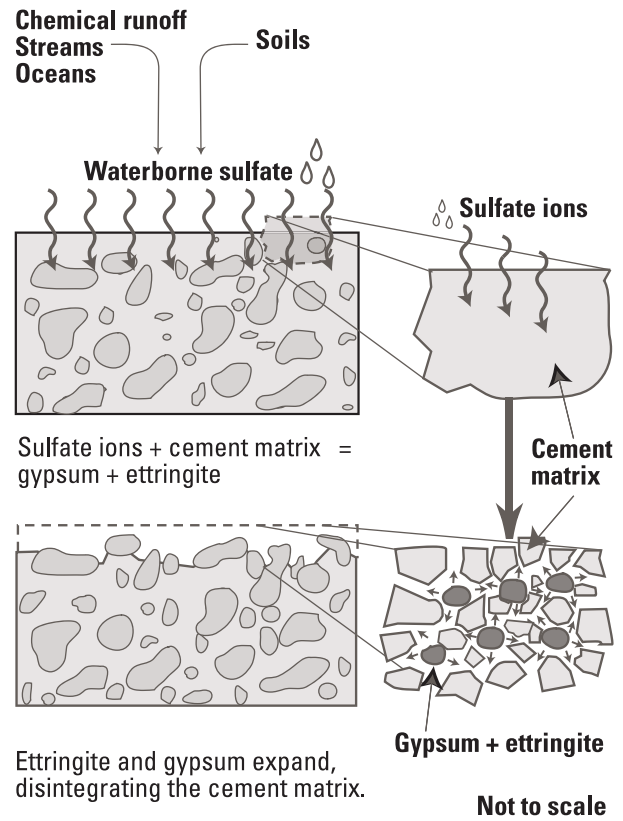

Adapted from Emmons 1993

Figure 6-38. Sulfate attack is a chemical reaction between sulfates and the C₃A in cement, resulting in surface softening

Factors Affecting Sulfate Attack

Prevention of sulfate attack depends on protecting the concrete from infiltration by sulfate ions. For the best defense against external sulfate attack, consider the following:

- Design concrete with a low w/cm ratio (around 0.4 or lower).
- Use cements specially formulated for sulfate environments, such as ASTM C150/AASHTO M 85 Type II or V cements, ASTM C595/AASHTO M 240 moderate or high sulfate-resistant cements, or ASTM C 1157 Types MS or HS.

Note that, although the use of sulfate-resistant cements is beneficial, it may not be sufficient to protect concrete against sulfate attack. ACI 201.2R-16 *Guide to Durable Concrete* provides recommendations for concrete in various sulfate exposures. It is important to use the test method described in the guide to assess the sulfate content to prevent misleading data.

- Use SCMs with proper proportioning and material selection. Supplementary cementitious materials improve sulfate resistance by reducing permeability of the concrete and by diluting the C_3A content of the system. Concretes made with Class F ashes will be more sulfate resistant than those made with Class C ashes. Some Class C ashes have been shown to reduce sulfate resistance at normal dosage rates and are not recommended for use in concrete exposed to moderate or high sulfate environments.
- The maximum w/cm ratio should not exceed 0.40 and may need to be lower in more severe sulfate exposures.
- Extend wet curing to increase concrete's strength development and decrease its permeability, thus improving its sulfate resistance.

Sulfate attack is more severe at locations where the concrete is exposed to wetting and drying cycles than at locations where there is continuously wet exposure due to salt deposition. Some of this damage might be due to physical salt attack, which is not a chemical degradation but instead damage due to salt crystallization occurring at the evaporative front (ACI 201.2R-16). However, if the sulfate exposure is severe enough, even continuously moist sections can be attacked by sulfates with time.

Testing

Tests on the sulfate resistance of cements are usually performed on mortars: ASTM C452 is used for portland cement and ASTM C1012 is used for hydraulic cements, including blended cements.

There are currently no well-accepted tests for sulfate resistance of concrete in the US. Most laboratory investigations use concrete prisms immersed in sulfate solutions and try various methods to evaluate damage. More severe tests incorporate a wetting/drying regime into the testing.

Alkali-Silica Reaction

Key Points

- A chemical reaction that occurs when silica compounds in some aggregates become soluble in the high-alkali environment of the pore solution and in the presence of water and calcium forms a gel that imbibes water, expanding and fracturing the concrete.
- Damaging expansion and cracking due to ASR can be controlled in several ways:
 - Using nonreactive aggregates
 - Blending sufficient nonreactive aggregate with reactive aggregate
 - Using SCMs in proper proportions
 - Using low-alkali cements
 - Using blended cements
 - Using lithium compounds
- Testing specifications:
 - ASTM C118 and AASHTO R 80 are protocols to assess aggregates and to select appropriate prevention approaches.

Simple Definition

Alkali-silica reaction is a potentially harmful condition in concrete resulting from the dissolution of some siliceous minerals in aggregates ([see Aggregate Durability in Chapter 4](#), including [Tables 4-11 and 4-12](#)) in the high alkaline (pH) pore solutions found in concrete. Over time, the product of dissolution combines with calcium to form a gelatinous alkali-silicate referred to as ASR gel. The ASR gel can absorb water and expand, leading to concrete cracking and reduced service life (Figure 6-39).

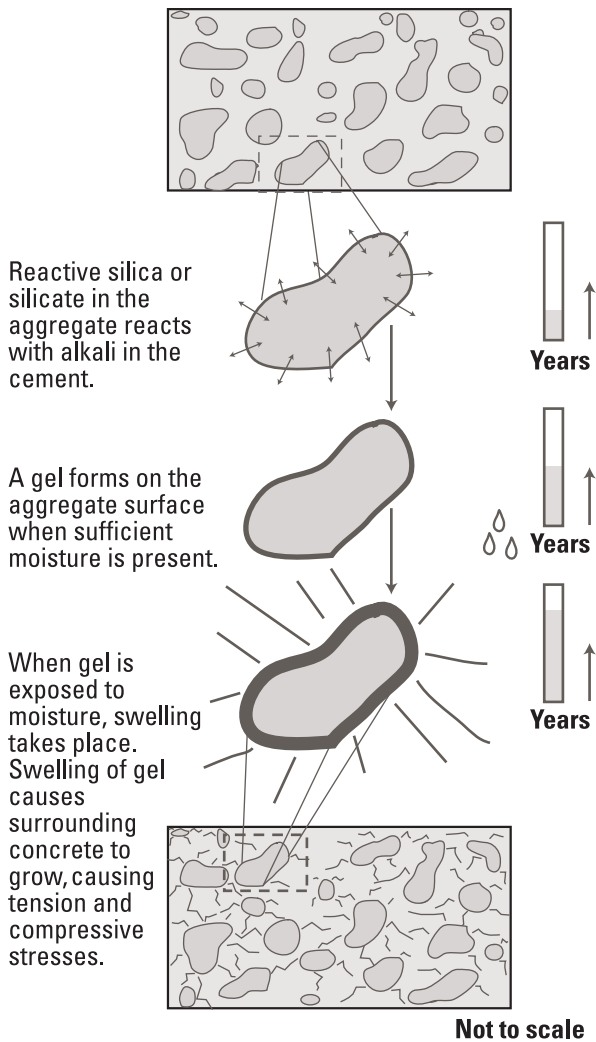

Adapted from Emmons 1993

Figure 6-39. Alkali-silica reaction is an expansive reaction of reactive aggregates, alkali hydroxides, and water that may cause cracking in concrete

Significance of Alkali-Silica Reaction

The amount of gel formed in the concrete depends on the amount and type of silica in the aggregate and the alkali hydroxide concentration in the concrete pore solution. The reactivity is potentially harmful only when it produces significant expansion. For more information, see AASHTO R 80 or ASTM C1778.

Typical indicators of deleterious ASR include a network of cracks that are perpendicular to joints, closed or spalled joints, or relative displacements of adjacent slabs. Because ASR is slow, deterioration often takes several years to develop. Alkali-silica reactions can cause serviceability problems and can exacerbate other deterioration mechanisms, such as those that occur in frost, deicer, or sulfate exposures.

For most reactive aggregates, the reaction can be mitigated or controlled through proper concrete materials selection or other means. In fact, even though potentially reactive aggregates exist throughout North America, ASR distress in concrete is no longer a common problem. There are a number of reasons for this:

- Many aggregates are not reactive
- Known reactive aggregates are avoided
- Some forms of ASR do not produce significant deleterious expansion
- The appropriate use of certain pozzolans or slags controls ASR
- In many concrete mixtures, the alkali content of the concrete is low enough to limit the reaction
- The concrete in service is dry enough to limit the reaction

Factors Affecting Alkali-Silica Reaction

For ASR to occur, three conditions must be present:

- Reactive forms of silica in the aggregate
- High-alkali (pH) pore solution (water in the paste pores)
- Sufficient moisture

If any one of these conditions is absent, ASR gel cannot form and deleterious expansion from ASR cannot occur. Therefore, the best way to avoid ASR is through good mix design and materials selection. The protocols provided in AASHTO R 80 and ASTM C1778 should be followed.

Design mixes specifically to control ASR, preferably using locally available materials. Use nonreactive aggregates, if possible.

If you must use some reactive aggregate, use SCMs or blended cements proven by testing to control ASR or limit the alkali content of the concrete. Where applicable, different amounts of pozzolan or slag should be tested to determine the optimum dosage. Too low a dosage of fly ash may exacerbate the problem. Low-calcium (typically Class F) fly ashes are generally better at mitigating ASR than high-calcium (typically Class C) fly ashes. Ground granulated blast furnace slag and natural pozzolans are also generally effective in mitigating ASR when used in the proper dosages. Expansion usually decreases as the dosage of the pozzolan or slag increases.

Using portland cement with an alkali content of not more than 0.60 percent (equivalent sodium oxide) can often (but not always) control ASR. Its use has been successful with slightly reactive to moderately reactive aggregates. However, low-alkali cements are not available in all areas and are not effective against all reactive aggregates.

Testing

Aggregate should be evaluated for its susceptibility to ASR, and, if it is considered reactive, then preventive measures need to be applied and evaluated. These are presented in AASHTO R 80 and ASTM C1778. Both provide a protocol to work through this process.

The approach is summarized in Figure 6-40.

The AASHTO R 80 and ASTM C1778 protocols also evaluate concrete mixtures for susceptibility to ACR. Although rare, ACR can be extremely damaging, and there is no way to mitigate it other than to reject the use of ACR-susceptible aggregates in concrete.

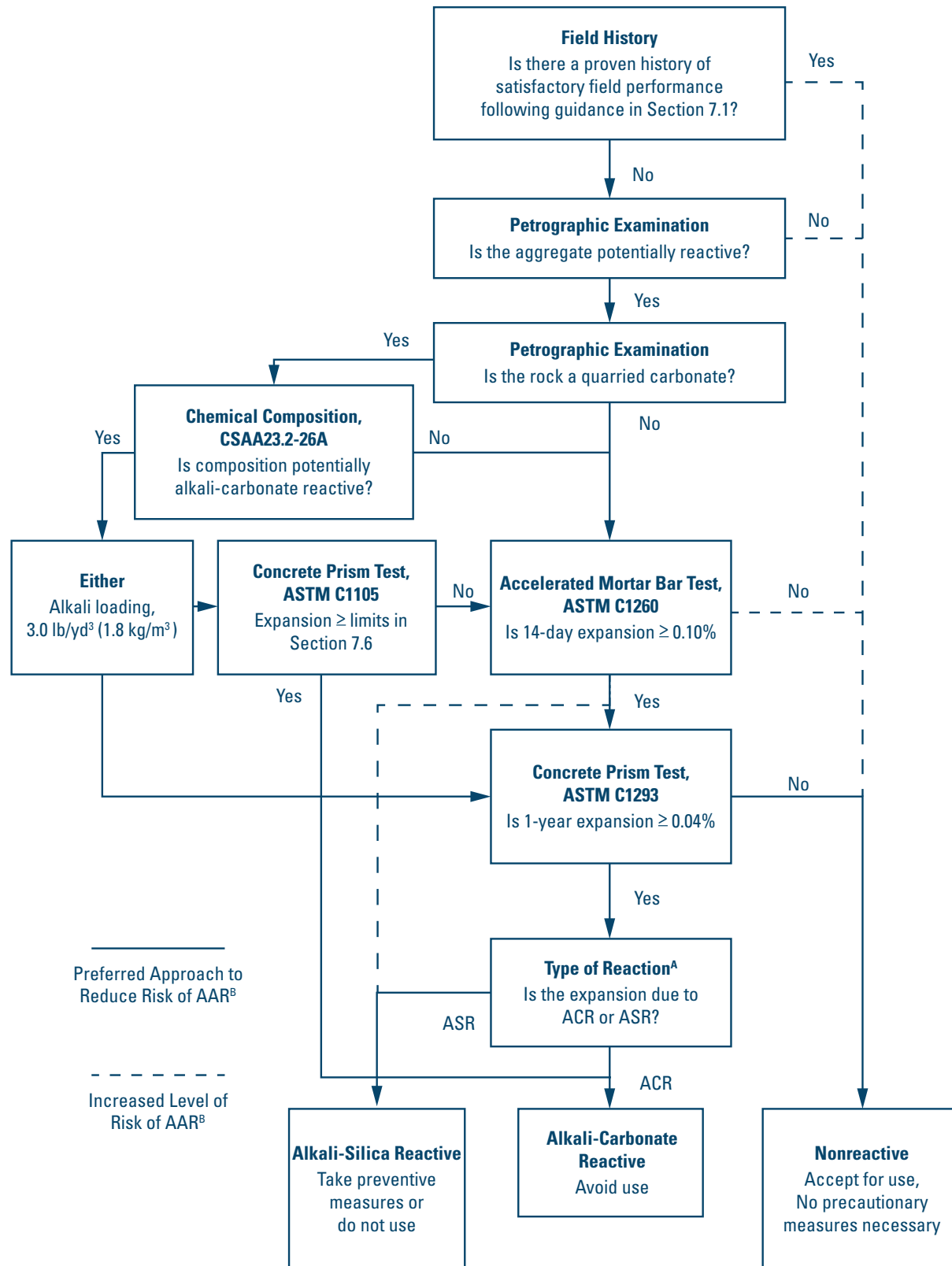

AAR = alkali-aggregate reaction

ACR = alkali-carbonate reactive

^A The type of reaction only needs to be determined after the concrete prism test if the aggregate being tested is a quarried carbonate that has been identified as being potentially alkali-carbonate reactive by chemical composition in accordance with test method CSA A23.2-26A.

^B The solid lines show the preferred approach. However, some agencies may want to reduce the amount of testing and accept a higher level of risk, and this can be achieved by following the direction of the hashed lines.

Recreated from ASTM C1778-16, Copyright © 2016 ASTM International, used with permission

Figure 6-40. ASR protocol

References

- AASHTO M 85 *Standard Specification for Portland Cement.*
- AASHTO M 157 *Standard Specification for Ready-Mixed Concrete.*
- AASHTO M 201 *Standard Specification for Mixing Rooms, Moist Cabinets, Moist Rooms, and Water Storage Tanks Used in the Testing of Hydraulic Cements and Concretes.*
- AASHTO M 240 *Blended Hydraulic Cement.*
- AASHTO M 295 *Standard Specification for Coal Fly Ash and Raw or Calcined Natural Pozzolan for Use as a Mineral Admixture in Concrete.*
- AASHTO PP 84-18 *Standard Practice for Developing Performance Engineered Concrete Pavement Mixtures.*
- AASHTO R 60 *Standard Method of Test for Sampling Freshly Mixed Concrete.*
- AASHTO R 80-17 *Standard Practice for Determining the Reactivity of Concrete Aggregates and Selecting Appropriate Measures for Preventing Deleterious Expansion in New Concrete Construction.*
- AASHTO T 22 *Compressive Strength of Cylindrical Concrete Specimens.*
- AASHTO T 23 *Standard Method of Test for Making and Curing Concrete Test Specimens in the Field*
- AASHTO T 24 *Standard Method of Test for Obtaining and Testing Drilled Cores and Sawed Beams of Concrete.*
- AASHTO T 96 *Resistance to Degradation of Small-Size Coarse Aggregate by Abrasion and Impact in the Los Angeles Machine.*
- AASHTO T 97 *Standard Method of Test for Flexural Strength of Concrete (Using Simple Beam with Third Point Loading).*
- AASHTO T 104 *Soundness of Aggregate by Use of Sodium Sulfate or Magnesium Sulfate.*
- AASHTO T 119 *Standard Method of Test for Slump of Hydraulic Cement Concrete.*
- AASHTO T 121 *Density (Unit Weight), Yield, and Air Content (Gravimetric) of Concrete.*
- AASHTO T 126 *Standard Method of Test for Making and Curing Concrete Test Specimens in the Laboratory.*
- AASHTO T 131 *Standard Method of Test for Time of Setting of Hydraulic Cement by Vicat Needle.*
- AASHTO T 152 *Standard Method of Test for Air Content of Freshly Mixed Concrete by the Pressure Method.*
- AASHTO T 154 *Standard Method of Test for Time of Setting of Hydraulic Cement Paste by Gillmore Needles.*
- AASHTO T 158 *Standard Method of Test for Bleeding of Concrete.*
- AASHTO T 160 *Standard Method of Test for Length Change of Hardened Hydraulic Cement Mortar and Concrete.*
- AASHTO T 161 *Standard Method of Test for Resistance of Concrete to Rapid Freezing and Thawing.*
- AASHTO T 177 *Standard Method of Test for Flexural Strength of Concrete (Using Simple Beam with Center-Point Loading).*
- AASHTO T 185 *Standard Method of Test for Early Stiffening of Portland Cement (Mortar Method).*
- AASHTO T 186 *Standard Method of Test for Early Stiffening of Hydraulic Cement (Paste Method).*
- AASHTO T 196 *Standard Method of Test for Air Content of Freshly Mixed Concrete by the Volumetric Method.*
- AASHTO T 197 *Standard Method of Test for Time of Setting of Concrete Mixtures by Penetration Resistance.*
- AASHTO T 198 *Standard Method of Test for Splitting Tensile Strength of Cylindrical Concrete Specimens.*
- AASHTO T 231 *Standard Practice for Capping Cylindrical Concrete Specimens.*
- AASHTO T 277 *Electrical Indication of Concrete's Ability to Resist Chloride Ion Penetration.*
- AASHTO T 303 *Accelerated Detection of Potentially Deleterious Expansion of Mortar Bars Due to ASR.*
- AASHTO T 309-99 *Standard Method of Test for Temperature of Freshly Mixed Portland Cement Concrete.*
- AASHTO T 334-08 *Standard Method of Test for Estimating the Cracking Tendency of Concrete.*
- AASHTO T 336 *Standard Method of Test for Coefficient of Thermal Expansion of Hydraulic Cement Concrete.*

AASHTO T 358-17 Surface Resistivity Indication of Concrete's Ability to Resist Chloride Ion Penetration.

AASHTO TP 64 Standard Method of Test for Predicting Chloride Penetration of Hydraulic Cement Concrete by the Rapid Migration Procedure.

AASHTO TP 118 Standard Method of Test for Characterization of the Air-Void System of Freshly Mixed Concrete by the Sequential Pressure Method.

AASHTO TP 119-15 Standard Method of Test for Electrical Resistivity of a Concrete Cylinder Tested in a Uniaxial Resistance Test.

AASHTO TP 129 Standard Method of Test for Vibrating Kelly Ball (Vkelly) Penetration in Fresh Portland Cement Concrete.

AASHTO TP 363-17 Evaluating Stress Development and Cracking Potential due to Restrained Volume Change Using a Dual Ring Test.

ASTM C31/C31M-03a Standard Practice for Making and Curing Concrete Test Specimens in the Field.

ASTM C39 Standard Test Method for Compressive Strength of Cylindrical Concrete Specimens.

ASTM C42/C42M-04 Standard Test Method for Obtaining and Testing Drilled Cores and Sawed Beams of Concrete.

ASTM C78 Standard Test Method for Flexural Strength of Concrete (Using Simple Beam with Third-Point Loading).

ASTM C88-99a Standard Test Method for Soundness of Aggregates by Use of Sodium Sulfate or Magnesium Sulfate.

ASTM C94/C94M-18 Standard Specification for Ready-Mixed Concrete.

ASTM C131-03 Standard Test Method for Resistance to Degradation of Small-Size Coarse Aggregate by Abrasion and Impact in the Los Angeles Machine.

ASTM C138/C138M-01a Standard Test Method for Density (Unit Weight), Yield, and Air Content (Gravimetric) of Concrete.

ASTM C143/C143M-03 Standard Test Method for Slump of Hydraulic Cement Concrete.

ASTM C150 Standard Specification for Portland Cement.

ASTM C157M-04 Standard Test Method for Length Change of Hardened Hydraulic Cement, Mortar, and Concrete.

ASTM C172 Standard Practice for Sampling Freshly Mixed Concrete.

ASTM C173/C173M-01e1 Standard Test Method for Air Content of Freshly Mixed Concrete by the Volumetric Method.

ASTM C186-17 Standard Test Method for Heat of Hydration of Hydraulic Cement.

ASTM C191 Standard Test Methods for Time of Setting of Hydraulic Cement by Vicat Needle.

ASTM C192/C192M-02 Standard Practice for Making and Curing Concrete Test Specimens in the Laboratory.

ASTM C215-02 Standard Test Method for Fundamental Transverse, Longitudinal, and Torsional Resonant Frequencies of Concrete Specimens.

ASTM C227 Standard Test Method for Potential Alkali Reactivity of Cement-Aggregate Combinations (Mortar-Bar Method).

ASTM C231/231M Standard Test Method for Air Content of Freshly Mixed Concrete by the Pressure Method.

ASTM C232 Standard Test Method for Bleeding of Concrete.

ASTM C266 Test Method for Time of Setting of Hydraulic-Cement Paste by Gillmore Needles.

ASTM C293 Standard Test Method for Flexural Strength of Concrete (Using Simple Beam with Center-Point Loading).

ASTM C295, C295-03 Standard Guide for Petrographic Examination of Aggregates for Concrete.

ASTM C359 Standard Test Method for Early Stiffening of Hydraulic Cement (Mortar Method).

ASTM C403M Standard Test Method for Time of Setting of Concrete Mixtures by Penetration Resistance.

ASTM C418-98 Standard Test Method for Abrasion Resistance of Concrete by Sandblasting.

ASTM C441 Standard Test Method for Effectiveness of Pozzolans or Ground Blast-Furnace Slag in Preventing Excessive Expansion of Concrete Due to the Alkali-Silica Reaction.

ASTM C451 Standard Test Method for Early Stiffening of Hydraulic Cement (Paste Method).

ASTM C452 Standard Test Method for Potential Expansion of Portland Cement Mortars Exposed to Sulfate.

ASTM C457-98 Standard Test Method for Microscopical Determination of Parameters of the Air-Void System in Hardened Concrete.

ASTM C469 Standard Test Method for Static Modulus of Elasticity and Poisson's Ratio of Concrete in Compression.

ASTM C496 Standard Test Method for Splitting Tensile Strength of Cylindrical Concrete Specimens.

ASTM C535 Standard Method of Test for Resistance to Degradation of Large-Size Coarse Aggregate by Abrasion and Impact in the Los Angeles Machine.

ASTM C595-18 Standard Specification for Blended Hydraulic Cements.

ASTM C617-98 Standard Practice for Capping Cylindrical Concrete Specimens.

ASTM C618-19 Standard Specification for Coal Fly Ash and Raw or Calcined Natural Pozzolan for Use in Concrete.

ASTM C666-97 Standard Test Method for Resistance of Concrete to Rapid Freezing and Thawing.

ASTM C672/C672M-03 Standard Test Method for Scaling Resistance of Concrete Surfaces Exposed to Deicing Chemicals.

ASTM C779/C779M-00 Standard Test Method for Abrasion Resistance of Horizontal Concrete Surfaces.

ASTM C827-01a Standard Test Method for Change in Height at Early Ages of Cylindrical Specimens of Cementitious Mixtures.

ASTM C856 Standard Practice for Petrographic Examination of Hardened Concrete.

ASTM C873-99 Standard Test Method for Compressive Strength of Concrete Cylinders Cast in Place in Cylindrical Molds.

ASTM C918-97e1 Standard Test Method for Measuring Early-Age Compressive Strength and Projecting Later-Age Strength.

ASTM C 944-99 Standard Test Method for Abrasion Resistance of Concrete or Mortar Surfaces by the Rotating-Cutter Method.

ASTM C1012 Standard Test Method for Length Change of Hydraulic Cement Mortars Exposed to a Sulfate Solution.

ASTM C1064/C1064M Standard Test Method for Temperature of Freshly Mixed Hydraulic-Cement Concrete.

ASTM C1074 Standard Practice for Estimating Concrete Strength by the Maturity Method.

ASTM C1138-97 Standard Test Method for Abrasion Resistance of Concrete (Underwater Method).

ASTM C1157 Standard Performance Specification for Hydraulic Cement.

ASTM C1202 Standard Test Method for Electrical Indication of Concrete's Ability to Resist Chloride Ion Penetration.

ASTM C1231/C1231M-15 Standard Practice for Use of Unbonded Caps in Determination of Compressive Strength of Hardened Cylindrical Concrete Specimens.

ASTM C1260 Standard Test Method for Potential Alkali Reactivity of Aggregates (Mortar-Bar Method).

ASTM C1293 Standard Test Method for Determination of Length Change of Concrete Due to Alkali-Silica Reaction.

ASTM C1543-02 Standard Test Method for Determining the Penetration of Chloride Ion into Concrete by Ponding.

ASTM C1556-04 Standard Test Method for Determining the Apparent Chloride Diffusion Coefficient of Cementitious Mixtures by Bulk Diffusion.

ASTM C1567-04 Standard Test Method for Determining the Potential Alkali-Silica Reactivity of Combinations of Cementitious Materials and Aggregate (Accelerated Mortar-Bar Method).

ASTM C1581-04 Standard Test Method for Determining Age at Cracking and Induced Tensile Stress Characteristics of Mortar and Concrete under Restrained Shrinkage.

ASTM C1585-04 Standard Test Method for Measurement of Rate of Absorption of Water by Hydraulic-Cement Concretes.

ASTM C1646 Standard Practice for Making and Curing Test Specimens for Evaluating Resistance of Coarse Aggregate to Freezing and Thawing in Air-Entrained Concrete.

ASTM C1753 Standard Practice for Evaluating Early Hydration of Hydraulic Cementitious Mixtures Using Thermal Measurements.

ASTM C1778 Standard Guide for Reducing the Risk of Deleterious Alkali-Aggregate Reaction in Concrete.

EN 12350-3:2009 Testing Fresh Concrete. Vebe Test.

EN 12350-4 Testing Fresh Concrete. Degree of Compaction.

ACI. 1997. *Texturing Concrete Pavements*. ACI 325.6R. American Concrete Institute, Farmington Hills, MI.

———. 2007. *Specification for Hot Weather Concreting*. ACI 305.1-06. American Concrete Institute, Farmington Hills, MI.

———. 2011. *Evaluation of Strength Test Results of Concrete*. ACI 214R-11. American Concrete Institute, Farmington Hills, MI.

———. 2012. *Guide to Mass Concrete*. 207.1R-05 (reapproved 2012). American Concrete Institute, Farmington Hills, MI.

———. 2014. *Building Code Requirements for Structural Concrete and Commentary*. ACI 318-14. American Concrete Institute, Farmington Hills, MI.

———. 2015. *Guide for Construction of Concrete Pavements*. ACI 325.9R-15. American Concrete Institute, Farmington Hills, MI.

———. 2016. *Guide to Durable Concrete*. ACI 201.2R-16. American Concrete Institute, Farmington Hills, MI.

———. 2016. *Guide to External Curing of Concrete*. ACI 308R-16. American Concrete Institute, Farmington Hills, MI.

———. 2018. *Concrete Terminology*. ACI CT-18. American Concrete Institute, Farmington Hills, MI. https://www.concrete.org/store/productdetail.aspx?ItemID=CT18&Format=DOWNLOAD&Language=English&Units=US_Units.

ACPA. 1994. *Fast-Track Concrete Pavements*. TB004.02P. American Concrete Pavement Association, Skokie, IL.

Baalbaki, W., B. Benmokrane, O. Chaallal, and P. C. Aítcin. 1991. Influence of Coarse Aggregate on Elastic Properties of High-Performance Concrete. *ACI Materials Journal*, Vol. 88, No. 5, pp. 499–503.

Bureau de Normalisation du Québec. 2002. Détermination de la Résistance à l'écaillage du Béton soumis à des Cycles de Gel-Dégel en contact avec des Sels Fondants. BNQ NQ 2621-900, Annexe A, pp. 19–22.

Cable, J. and L. L. McDaniel. 1998. *Effect of Mix Times on PCC Properties*. Iowa Department of Transportation, Ames, IA. <https://www.fhwa.dot.gov/pavement/pubs/013553.pdf>.

Carino, N. J. 1994. Prediction of Potential Concrete Strength at Later Ages. In *Significance of Tests and Properties of Concrete and Concrete Making Materials*. American Society for Testing and Materials, West Conshohocken, PA. pp. 140–152.

Cook, D., A. Ghaeezadeh, and T. Ley. 2013. *Investigation of Optimized Graded Concrete for Oklahoma*. Oklahoma Transportation Center, Midwest City, OK.

Cordon, W. A. 1966. *Freezing and Thawing of Concrete—Mechanisms and Control*. ACI Monograph No. 3. American Concrete Institute, Farmington Hills, MI.

Daniel, D. G. 2006. Factors Influencing Concrete Workability. Chapter 8 in *Significance of Tests and Properties of Concrete and Concrete-Making Materials*. STP 169D. ASTM International, West Conshohocken, PA. pp. 59–72.

Detwiler, R. J. and P. C. Taylor. 2005. *Specifier's Guide to Durable Concrete*. Portland Cement Association, Skokie, IL.

Emmons, P. H. 1993. *Concrete Repair and Maintenance Illustrated*. R. S. Means Company, Inc., Kingston, MA.

Farny J. A. and W. C. Panarese. 1993. *High Strength Concrete*. First Edition. Portland Cement Association, Skokie, IL.

Folliard, K. J., M. D. A. Thomas, and K. E. Kurtis. 2003. *Guidelines for the Use of Lithium to Mitigate or Prevent Alkali-Silica Reaction (ASR)*. FHWA-RD-03-047. Federal Highway Administration, Turner-Fairbank Highway Research Center, McLean, VA. <https://www.fhwa.dot.gov/publications/research/infrastructure/pavements/pccp/03047/>.

Goodspeed, C. H., S. Vanikar, and R. Cook. 1996. High-Performance Concrete Defined for Highway Structures. *Concrete International*, Vol. 18, No. 2, pp. 62–67.

Janssen, D. J. and M. B. Snyder. 1994. *Resistance of Concrete to Freezing and Thawing*. SHRP-C-391. Strategic Highway Research Program, Washington, DC.

Jones, W., Y. Farnam, P. Imbrock, J. Spiro, C. Villani, M. Golias, J. Olek, and W. J. Weiss. 2013. *An Overview of Joint Deterioration in Concrete Pavement: Mechanisms, Solution Properties, and Sealers*. Purdue University, West Lafayette, IN.

- Kandhal, P. S. and F. Parker, Jr. 1998. *NCHRP Report 405: Aggregate Tests Related to Asphalt Concrete Performance in Pavements*. National Cooperative Highway Research Program, Washington, DC.
- Klieger, P. 1957. *Curing Requirements for Scale Resistance of Concrete*. Bulletin 150. Highway Research Board, Washington, DC. pp. 18–31.
- . 1994. Air-Entraining Admixtures. Chapter 44 in *Significance of Tests and Properties of Concrete and Concrete Making Materials*. American Society for Testing and Materials, West Conshohocken, PA. pp. 484–490.
- Kosmatka S. H. 2006. Bleed Water. In *Significance of Tests and Properties of Concrete and Concrete Making Materials*. American Society for Testing and Materials, West Conshohocken, PA. pp. 99–124.
- Kosmatka, S. H. and M. Wilson. 2016. *Design and Control of Concrete Mixtures*. 16th Edition. Portland Cement Association, Skokie, IL.
- Ley, M. T., D. Welchel, J. Peery, S. Khatibmasjedi, and J. LeFlore. 2017. Determining the air-void distribution in fresh concrete with the Sequential Air Method. *Construction and Building Materials*, Vol. 150, pp. 723–737.
- Li, W., M. Pour-Ghaz, J. Castro, and J. Weiss. 2012. Water Absorption and Critical Degree of Saturation Relating to Freeze–Thaw Damage in Concrete Pavement Joints. *Journal of Materials in Civil Engineering*, Vol. 24, No. 3, pp. 299–307.
- Liu, T. 1994. Abrasion Resistance. Chapter 19 in *Significance of Tests and Properties of Concrete and Concrete Making Materials*. American Society for Testing and Materials, West Conshohocken, PA. pp. 182–191.
- Marchand, J., R. Pleau, and R. Gagné. 1995. Deterioration of Concrete due to Freezing and Thawing. In *Materials Science of Concrete IV*. American Ceramic Society, Westerville, OH. pp. 283–354.
- Mielenz, R. C., V. E. Wolkodoff, J. E. Backstrom, and R. W. Burrows. 1958. Origin, Evolution, and Effects of the Air Void System in Concrete: Part 4—The Air Void System in Job Concrete. *ACI Journal*, Vol. 55, No. 10, pp. 507–517.
- Mindess, S. and J. F. Young. 1981. *Concrete*. Prentice-Hall, Englewood Cliffs, NJ.
- Mindess, S., J. F. Young, and D. Darwin. 2003. *Concrete*. Second Edition. Prentice Hall, Upper Saddle River, NJ.
- Monical, J., C. Villani, Y. Farnam, E. Unal, and J. Weiss. 2016. Using Low Temperature Differential Scanning Calorimetry to Quantify Calcium Oxychloride Formation for Cementitious Materials in the Presence of CaCl₂. *Journal of Advances in Civil Engineering Materials*, Vol. 5, No. 1, pp. 1–15.
- Neville, A. M. 1996. *Properties of Concrete*. Fourth Edition. John Wiley and Sons, New York, NY.
- Newlon, H. and T. M. Mitchell. 1994. Freezing and Thawing. In *Significance of Tests and Properties of Concrete and Concrete Making Materials*. American Society for Testing and Materials, West Conshohocken, PA. pp. 153–163.
- Penttala, V. 1998. Freezing-Induced Strains and Pressures in Wet Porous Materials and Especially in Concrete Mortars. *Advanced Cement Based Materials*, Vol. 7, No. 1, pp. 8–19.
- Poole, T. S. 2005. *Guide for Curing of Portland Cement Concrete Pavements*. FHWA-RD-02-099. Federal Highway Administration, Turner-Fairbank Highway Research Center, McLean, VA. <https://www.fhwa.dot.gov/publications/research/infrastructure/pavements/pccp/02099/>.
- Powers, T. C. 1945. Working Hypothesis for Further Studies of Frost Resistance of Concrete. *ACI Journal*, Vol. 41, No. 1, pp. 245–272.
- . 1954. Void Spacing as a Basis for Producing Air-Entrained Concrete. *ACI Journal*, Vol. 50, No. 9, pp. 741–760.
- . 1955. Basic Considerations Pertaining to Freezing and Thawing Tests. *ASTM Proceedings*, Vol. 55, pp. 1132–115.
- Powers, T. C. and R. A. Helmuth. 1953. Theory of Volume Changes in Hardened Portland Cement Paste During Freezing. *Proceedings of the 32nd Annual Meeting of the Highway Research Board*, January 13–16, Washington, DC. Vol. 32, pp. 285–297.

Powers, T. C. and T. F. Willis. 1950. The Air Requirement of Frost Resistant Concrete. *Proceedings of the 29th Annual Meeting of the Highway Research Board*, Vol. 29, 184–211.

Scanlon, J. M. 1994. Factors Influencing Concrete Workability. In *Significance of Tests and Properties of Concrete and Concrete-Making Materials*. STP 169C. ASTM International, West Conshohocken, PA. pp. 49–64.

Scherer, G. W., and J. J. Valenza II. 2005. Mechanisms of Frost Damage. In *Materials Science of Concrete VII*. American Ceramic Society, Westerville, OH.

Spragg, R., J. Castro, T. Nantung, M. Paredes, and W. J. Weiss. 2012. Variability Analysis of the Bulk Resistivity Measured Using Concrete Cylinders. *Advances in Civil Engineering Materials*, Vol. 1, No. 1, pp. 1–17.

Sutter, L., K. Peterson, G. Julio-Betancourt, D. Hooton, T. Van Dam, and K. Smith. 2008. *The Deleterious Chemical Effects of Concentrated Deicing Solutions on Portland Cement Concrete*. South Dakota Department of Transportation. Pierre, SD.

Taylor, P. C. 2013. *Concrete Curing*. CRC Press, Boca Raton, FL.

Taylor, P. C, F. Bektas, E. Yurdakul, and H. Ceylan. 2012. *Optimizing Cementitious Content in Concrete Mixtures for Required Performance*. National Concrete Pavement Technology Center, Ames, IA.

Tennis, P. D., M. D. A. Thomas, and W. J. Weiss. 2011. *State-of-the-Art Report on Use of Limestone in Cements at Levels of up to 15%*. Portland Cement Association, Skokie, IL.

Todak, H., C. Lucero, and W. J. Weiss. 2015. Why is the Air There? Thinking about Freeze–Thaw in Terms of Saturation. *Concrete in Focus*, Spring, pp. 0C3–0C7.

Voigt, G. 2000. *Specification Synthesis and Recommendations for Repairing Uncontrolled Cracks that Occur During Concrete Pavement Construction*. American Concrete Pavement Association, Skokie, IL.

Vogler, R. H. and G. H. Grove. 1989. Freeze-thaw testing of coarse aggregate in concrete: Procedures used by Michigan Department of Transportation and other agencies. *Cement, Concrete, and Aggregates*, Vol. 11, No. 1, pp. 57–66.

Wainwright, P. J. and N. Rey. 2000. Influence of Ground Granulated Blastfurnace Slag (GGBS) Additions and Time Delay on the bleeding of Concrete. *Cement and Concrete Composites*, Vol. 22, No. 4, pp. 253–257.

Wang, X., K. Wang, F. Bektas, and P. Taylor. 2012. Drying Shrinkage of Ternary Blend Concrete in Transportation Structures. *Journal of Sustainable Cement-Based Materials*, Vol. 1, No. 1-2, pp. 56–66.

Wang, X, P. Taylor, and X. Wang. 2016. Comparison of Setting Time Measured Using Ultrasonic Wave Propagation with Saw-Cutting Times on Pavements—A Case Study. Paper presented at the *11th International Conference on Concrete Pavements*, August 28–September 1, San Antonio, TX.

Weiss, W. J. 2014. *Relating Transport Properties to Performance in Concrete Pavements*. National Concrete Pavement Technology Center, Ames, IA.

Weiss, J. and Y. Farnam. 2015. *Concrete Pavement Joint Deterioration: Recent Findings to Reduce the Potential for Damage*. National Concrete Pavement Technology Center, Ames, IA.

Welchel, D. 2014. 2014. Determining the Size and Spacing of Air Bubbles in Fresh Concrete. MS thesis. Oklahoma State University, Stillwater, OK.

Whiting, D. A. and M. A. Nagi. 1998. *Manual of Control of Air Content in Concrete*. Portland Cement Association, Skokie, IL.

Wong, G. S., A. M. Alexander, R. Haskins, T. S. Poole, P. G. Malone, and L. Wakeley. 2000. *Portland Cement Concrete Rheology and Workability: Final Report*. FHWA-RD-00-025. Federal Highway Administration, Turner-Fairbank Highway Research Center, McLean, VA.

Wood, S. L. 1992. *Evaluation of the Long-Term Properties of Concrete*. Portland Cement Association, Skokie, IL. http://www2.cement.org/pdf_files/rd102.pdf.

Chapter 7

Mixture Design and Proportioning

Introduction	186
Sequence of Development	186
Aggregate Grading Optimization	188
Calculating Mixture Proportions	191
Adjusting Properties	196
References	200

Introduction

The terms “mixture design” and “mixture proportioning” are often used interchangeably.

- **Mixture design** is the process of determining required and specifiable properties of a concrete mixture, i.e., concrete properties required for the intended use, geometry, and exposure conditions.
- **Mixture proportioning** is the process of determining the quantities of concrete ingredients for a given set of requirements. The objective of proportioning concrete mixtures is to determine the most economical and practical combination of readily available materials to produce a concrete that will have the required properties.

The following are factors to be considered in concrete mixture design, as discussed in Chapter 6:

- Workability
- Durability
- Strength
- Economy

This chapter covers how the desired properties of concrete, discussed in [Chapter 6](#), can be achieved by optimized selection of concrete ingredients, discussed in [Chapter 4](#). The first section of this chapter discusses the sequences of activities when designing a mixture. The next section provides one method of optimizing the aggregates to obtain a good combined grading. The third section provides methods of determining mixture proportions, followed by possible modifications to achieve required properties.

Sequence of Development

Pre-Construction

Long before construction begins, the mixture specification must be established, bids evaluated, and trial batches prepared.

Specifications for Mixture Design

The process of designing a concrete mixture for a paving project begins with establishing the specification. There are two different approaches to concrete mixture specification:

- In the prescriptive (or method) approach, specifiers define the required materials, proportions, and construction methods based on fundamental principles and practices that have met performance requirements in the past.

- In the performance approach, specifiers identify functional requirements, such as strength, durability, and volume changes, and rely on concrete producers and contractors to develop concrete mixtures that meet those requirements.

All specifications should require the use of materials that meet minimum quality requirements, as described in Chapter 4. Prescriptive specifications also provide general guidelines for materials proportions, such as minimum and maximum replacement rates for supplementary cementitious materials (SCMs), water/cementitious materials (w/cm) ratio, aggregate grading requirements, and air content.

Traditionally, strength has been the primary acceptance criteria for concrete pavements on the assumption that sufficient strength ensured durability. However, with changes in the materials used in mixtures, the correlation between strength and durability is poor ([see Concrete Durability Is Affected by Many Concrete Properties in Chapter 6](#)). Many other factors contribute to pavement durability and should be considered in all stages of mixture design development. Non-strength-related concrete properties that influence durability include, but are not limited to, the following:

- Ability to resist the passage of fluids (transport properties)
- Ability to resist cold weather
- Sufficient strength
- Stable aggregates
- Limited shrinkage
- Appropriate workability

AASHTO PP 84 provides guidance on the minimum requirements for long-lasting pavement mixtures in a variety of environments.

At a minimum, specifications should require that trial batches (laboratory mixtures or field-batched mixtures) be prepared with job-specific materials and be tested for the required durability before paving. This may require trials to be conducted well before paving starts.

Many state and local departments of transportation (DOTs) have a listing of materials approved for concrete pavement construction. DOT certifications, together with other documentation, can help facilitate the materials approval review process.

Bidding

Economics are introduced as a constraint during the bidding stage. The contractor/concrete supplier is faced with the challenge of optimizing the mixture proportions with respect to cost, specifications, and performance requirements.

In most instances, prospective bidders can make reasonable assumptions because they have prior experience with the specifications and materials that will be used for the project. However, when specifications change, when new material sources are introduced, or when material sources change, it may be necessary to batch and test trial laboratory mixtures during the bidding process to reduce the risks of uncertainty. When testing before the bid is deemed appropriate, test results should be interpreted carefully with respect to sample size, test precision, and between-batch variability.

Laboratory Mixtures

There are a number of desktop approaches that can be used to provide a first approximation of mixture proportions. It is essential to prepare trial batches in the laboratory to ensure that the fresh and hardened properties comply with the requirements and that there are no incompatibilities between the materials at the temperatures at which the field mixtures will be made.

It is more convenient and economical to test concrete mixtures in the laboratory than to batch large quantities at a concrete plant. However, project conditions are often significantly different from the controlled environment of a laboratory. Production variability and testing variability need to be considered and understood when laboratory test results are interpreted. Ideally, some laboratory tests should be conducted at the same range of temperatures expected in the field.

Choose a qualified laboratory and design a testing plan that will provide the information desired. Laboratories and technicians should be experienced with concrete mixtures and accredited by an independent source. The testing plan should be specific and include all tests needed to verify the mixture properties. A suggested testing plan is shown in [Table 9-3](#).

When the potential for changes in materials sources or environment can be anticipated, it is advisable to batch additional laboratory mixtures with alternative materials and at different temperatures as a backup.

Anticipating Responses to Field Conditions

Laboratory mixtures should be batched so that the w/cm ratio and air content are representative of the mixture that will be used during paving. Field adjustments should be anticipated. It is advisable to have alternative mixtures approved that can be used in response to anticipated changes in materials sources and properties, environment, and demands on the concrete system.

When the raw materials are delivered to a concrete plant, it is too late to change the cement chemistry or the physical properties of the aggregates. Therefore, workability and air content are the primary concrete properties that can be manipulated during the batching process in the field. Field adjustments can be accomplished by modifying the dosage of the appropriate admixture and the water content, if still within the specified w/cm ratio.

Particular attention should be paid to preparing laboratory mixtures that are representative of the materials that will be used on the project. Portland cement and SCMs should be obtained from the suppliers' normal production and not be specially prepared. If necessary, aggregates can be screened into separate sizes and recombined to match as closely as possible the gradation that will be provided on the project.

Admixture interactions with lower slump mixtures can be dramatically impacted by a 10-degree difference in temperature. It is highly recommended that laboratory trials are prepared with materials preconditioned to anticipated field temperatures. In addition, conduct more workability trials at temperatures that are at least 10 degrees greater and lower than the anticipated project conditions.

The suggested laboratory testing plan should be followed for the target w/cm ratio. Additional laboratory mixtures should be proportioned and batched at different w/cm ratios, one higher and one lower.

Figure 7.1 provides an example of a plot showing the strength values for mixtures with different water/cement (w/c) ratios for a given cementitious system. This graph provides a basis for setting limits for field adjustments that may occur. At the point that concrete production begins, it is assumed that if the "recipe" is followed, an acceptable mixture will be delivered to the paver.

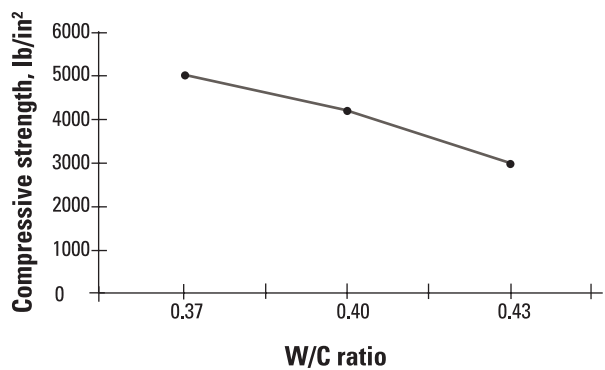

Figure 7-1. Example w/c ratio vs. strength curve

Once the mixture proportions have been proven in the laboratory, they can be tested in full-scale batches in the equipment that will be used on the project. This may appear expensive at the outset, but the savings in preventing later problems will more than offset this investment.

Field Trials

Just before paving, the mixture designs should be assessed in the field (unless there is experience with a similar mixture). This process is necessary to ensure that the materials and the final mixture are substantially the same as those that were used during the laboratory trials.

The following questions should be considered when verifying laboratory mixtures in the field:

- Are the fresh properties acceptable for the type of equipment and systems being used?
- Are there signs of incompatibilities?
- Are the performance properties from the field mixture comparable to those from the laboratory mixture?

Field trials are also a preferred practice when portable plants are used. The batching process, including mixture time, should be the same as that to be used during paving operations.

Workability of the field trial batches should be tested immediately after batching and at a later time to simulate the transportation time. Field trial batches should be remade until the desired workability is achieved after the estimated time in transport and then tested (Table 9-4).

Aggregate Grading Optimization

Control of the grading of the combined aggregates will help to achieve desirable workability while reducing the amount of paste required to meet engineering performance requirements.

Aggregates are generally chemically and dimensionally stable; therefore, it is desirable to maximize (within limits) aggregate content in concrete mixtures compared to the more chemically reactive cement paste. Well-graded aggregate reduces the space between aggregate particles that has to be filled with cement paste. Well-graded aggregate also contributes to achieving a workable mixture with a minimum amount of water.

Historically, aggregate gradation has been controlled by specifications that call out envelopes for individual fractions, typically the coarse aggregate and the fine aggregate. The shortcoming of this approach is that the gradation of the overall system is not addressed. Although it is sensible to stockpile coarse and fine fractions separately to prevent segregation, it is the combined system that is critical in the final mixture (Shilstone 1990).

The combined grading of aggregates used in concrete mixtures for paving applications can have a direct impact on workability and indirect on mixture performance. Mixtures that must be heavily vibrated because the workability is poor run the risk of segregation and creation of low-durability vibrator trails due to the air void system being compromised. Too often, additional water is used to compensate for poor workability, thus increasing the w/cm ratio and compromising potential durability and strength.

Mixtures that have well-graded aggregate and are responsive to vibration can lead to significant savings during construction because less effort is required to consolidate and finish the slab, and they are likely to last longer because the surface has not been overworked to create the required finish.

Shilstone considered that the best means of specifying and selecting mixture proportions is through combined grading analysis (Shilstone 1990). He developed tools to help in the process of selecting the combined aggregate grading that helped change the way this task is approached. Subsequent work by Ley (Cook et al. 2013) presented the so-called Tarantula curve that appears to be an effective means of “optimizing” the blend of aggregates using the materials available. The approach is to adjust the ratios of the aggregates available to achieve the desired combined gradation within the envelope.

The tools available are discussed in the following sections.

Tarantula Curve

An approach based on the percent-retained chart seems to provide promise of achieving reliably workable mixtures. The work was based on re-sieving a given set of materials to adjust the amount retained on one sieve size, by increments, and then to assess the workability of a mixture with fixed proportions (Cook 2013).

The Tarantula curve (Figure 7-2) provides an envelope in which a desirable amount of material retained on each sieve is reported.

Note that the vertical axis is based on volume rather than mass. The curve varies from the percent-retained chart in that for most fractions, the upper and lower limits are broadened, except for those on the #8 and #16 sieves that are reduced.

Historical sieve analysis data from MnDOT, which implemented the Shilstone approach to combined grading in the 1990s, show that over time, concrete mixtures have evolved to fit within the recommended limits of the Tarantula curve (Ley et al. 2014). This demonstrates that, with no knowledge of the Tarantula curve, contractor-developed mixtures were refined over time by trial and error to parallel the later-developed Tarantula curve. Similar results have been reported from mixtures in Iowa, North Dakota, and South Africa.

In addition, test sections slipformed in Texas with mixtures containing aggregate gradations falling within the Tarantula curve showed excellent response to vibration with very low cementitious materials content (-450 lb/yd³) (Cook et al. 2013).

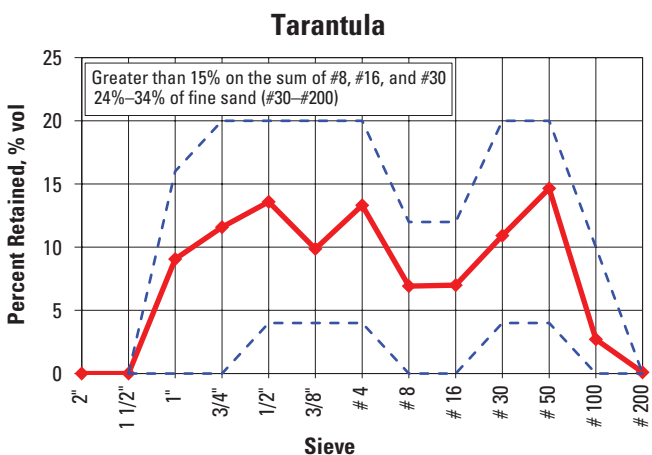

Figure 7-2. Sample combined gradation (solid center line) inside the Tarantula envelope (outer dotted lines)

Coarseness Factor Chart

The approach discussed by Shilstone (1990) was to analyze data using the Coarseness Factor Chart (CFC), and the combined aggregate grading was mathematically separated into three size groups:

- Coarse particles are those retained on the 3/8 in. sieve. They provide the primary body of the mixture.
- Intermediate particles pass the 3/8 in. sieve and are retained on the #8 sieve. These particles fill major voids between the coarse particles.
- Fine particles pass the #8 sieve.

The mass fractions of the combined aggregate that fall into each of the above size groups are used to calculate the coarseness factor and the workability factor. The coordinates from the data are plotted on the CFC (Figure 7-3).

The coarseness factor is the mass of the coarse-sized aggregate divided by the sum of the masses of the coarse and intermediate sizes.

$$\text{Coarseness Factor} = \frac{\% \text{ Coarse Aggregate}}{\% \text{ Coarse} + \% \text{ Intermediate Aggregate}} \cdot 100$$

The workability factor is the percent of the combined aggregate that passes the #8 sieve plus an adjustment for the amount of cementitious material in a mixture. The base cementitious materials content for the chart is 564 lb/yd³. The workability factor is increased 2.5 points for each 94 lb/yd³ variation from the base cementitious materials content. The coarseness factor and the workability factor establish the coordinates for a mixture.

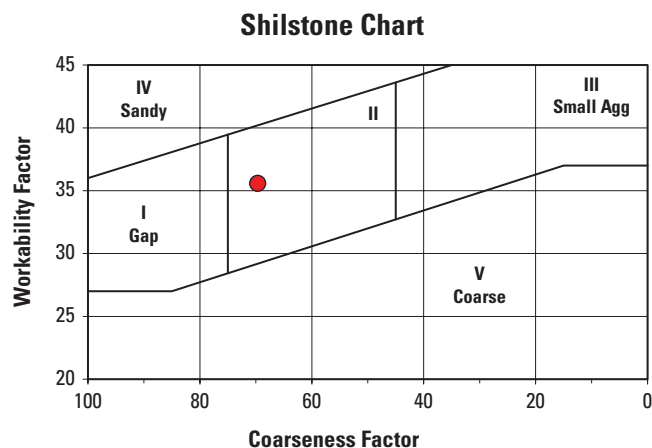

Figure 7-3. Modified coarseness factor chart

Zone II indicates a mixture for concretes with nominal maximum aggregate size from 2 in. through 3/4 in. This zone has been noted in several state specifications.

0.45 Power Chart

The Power 45 chart provides a means to describe a combined aggregate grading that theoretically achieves a maximum density. Sieve sizes are plotted to the 0.45 power along the horizontal X axis.

The cumulative amount of the total aggregate that passes each sieve can then be plotted and compared to a line on the Power 45 chart. A dense combined aggregate in a concrete mixture will follow a trend from the nominal maximum aggregate size to the #8 sieve and then bend downward, as shown in Figure 7-4.

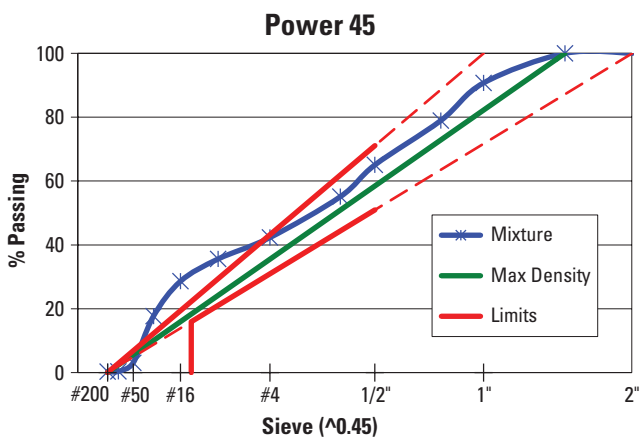

Figure 7-4. Sample Power 45 plot

The Power 45 chart should be used only as a guide and should not be incorporated into specifications. There is some discussion that a system that is tight on the Power 45 chart line is close to being too dense and that workability may be compromised.

Percent Aggregate Retained (Haystack) Chart

Figure 7-5 graphically illustrates the aggregate particle distribution as a plot of the percent of aggregate retained on each sieve size (Shilstone 1990). Traditional limits are shown on the plot, although these have been superseded by the Tarantula curve.

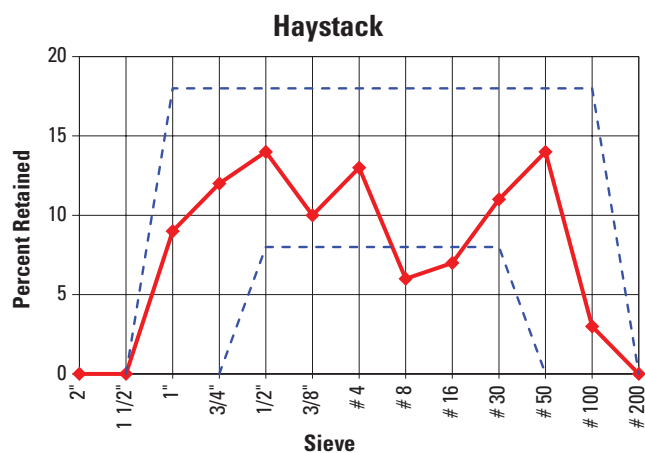

Figure 7-5. Sample Haystack plot

Calculating Mixture Proportions

Key Points

- Desktop calculations of mixture proportions must be followed by trial batches.
- Several methods of calculating proportions are available. Two are outlined here.

Calculated mixture proportions provide a starting point for trial batches. A concrete mixture can be proportioned by calculation, from field experience (historical data), or from trial mixtures. Several calculation methods are available, two of which are described in detail below. The requirements for a given mixture are often an act of balancing different (and possibly contradictory) requirements for the fresh and hardened properties.

Concrete mixture proportions are usually expressed on the basis of the mass of ingredients per unit volume. The unit of volume is either a cubic meter or a cubic foot of concrete. The methods involve using relative density (specific gravity) values for all the ingredients to calculate the absolute volume each will occupy in a unit volume of concrete (see [The Absolute Volume Method](#) at the end of this section). If the aggregate grading has been calculated using the Tarantula approach described earlier in this chapter, some of the steps in ACI 211 are unnecessary.

Further information on these and other methods can be found in the standard practices developed by the Portland Cement Association (PCA) (Kosmatka and Wilson 2016). Hover (1994 and 1995) provides a graphical process for designing concrete mixtures.

The Void Ratio Method

This approach is based on work by Wang et al. 2018 and sets up the problem in three stages: select an aggregate system, select a paste system, and select paste quantity. The premise behind the approach is that the amount of paste required in a mixture is dependent on the volume of voids in the combined aggregate system; all of the voids must be filled with some extra paste to separate the aggregate particles for workability and to ensure that all particles are effectively glued together. Excess paste generally has neutral or negative impacts on strength, permeability, and sustainability.

A spreadsheet has been developed to help users through this process and is available at <https://cptechcenter.org/publications/> under the Spreadsheets category.

Select an Aggregate System

Aggregates comprise the bulk of the volume and mass of a mixture, and as such are normally obtained from sources close to the batch plant. Care should be taken to ensure that they are not prone to alkali aggregate reaction or D-cracking. If use of alkali-silica reaction (ASR)-prone materials is unavoidable, then other actions may have to be taken to compensate, such as the use of appropriate amounts of SCMs.

In principle, the more aggregate can be put into a mixture, the lower the amount of paste required. This is beneficial because paste is generally the most expensive component. It also generates heat and is the component that contributes most to drying shrinkage. However, sufficient paste is required to achieve workability.

It should be noted that good concrete can still be made even if the gradation is less than ideal. The result may be that more paste is required and greater attention may have to be paid to workmanship to ensure that the mixture is well consolidated and finished.

As discussed previously, the fractions of the aggregates available should be adjusted to get as close as possible to the center of the Tarantula curve.

Having determined the aggregate sources and desired/achievable gradation, the volume of voids between the consolidated combined aggregate particles should be determined in accordance with ASTM C29. This is the amount of space between the aggregate particles that has to be filled with paste.

Select a Paste System

Many of the decisions that govern the quality of the paste in the mixture have been made as part of the design:

- W/cm ratio—for pavements, a range of 0.38 to 0.42 is suggested in cold climates
- Target air content—5 percent air volume behind the paver is recommended in cold climates
- SCM type and dose—this decision is influenced by local availability, cracking risk, and needs such as ASR prevention or oxychloride prevention

Target admixture dosages may be estimated at this stage but will need to be verified in trial batches.

Select the Paste Quantity

For a concrete mixture to be both workable and meet hardened performance requirements, it should contain a minimum amount of paste that is sufficient to fill all of the voids between the aggregate particles. An additional amount is also required to separate the aggregates slightly and to lubricate movement between them to make the mixture workable. This paste also acts to glue the aggregate particles together.

Experimentation has shown that the volume of paste should be about 1.5 to 1.75 times the volume of voids in the consolidated combined aggregate system. Greater amounts will increase workability. A minimum amount is required to achieve any workability, below which water-reducing admixtures provide no benefit.

Once some workability has been achieved by adding sufficient paste, then final slump can be controlled using water-reducing admixtures as needed.

Noting that some of the decisions made in later stages may impact factors from earlier stages, it is recommended that the process be iterated to find a good balance between conflicting demands.

The Absolute Volume Method

The absolute volume method of mixture proportioning may be summarized in 12 steps.

Step 1: Concrete Strength

The specified strength of a concrete mixture is selected considering the structural requirements of the concrete. The strength (flexural or compressive) required to resist the loads applied to the structure is part of the thickness design (see [Concrete Strength under Concrete Properties in Chapter 3](#)). Some durability issues can be addressed with a limit on the w/cm ratio (see [Transport \[Permeability\] in Chapter 6](#)).

In order to be reasonably sure of meeting the specified strength, the average design strength of a concrete

mixture must be greater than the specified strength to account for variations in materials and variations in the production, curing, and testing of cylinders. This is typically about 1,000 lb/in² (6.9 MPa). See ACI 301, section 4.2.3, for a statistical approach for determining the required average strength.

Step 2: Water/Cementitious Materials Ratio

The w/cm ratio is simply the mass of effective water divided by the mass of cementitious materials (portland cement, blended cement, fly ash, slag cement, silica fume, and natural pozzolans). The w/cm ratio used in the mixture design should be the lowest value required to meet both strength and durability requirements.

W/C or W/CM Ratio?

The w/cm ratio is often used synonymously with water/cement (w/c) ratio; however, some specifications differentiate between the two ratios. Traditionally, w/c refers to the mass ratio of water to portland cement or to blended cement, while w/cm refers to the mass ratio of water to cement plus any supplementary cementitious materials in the concrete.

ACI 201.2R-16 *Guide to Durable Concrete* provides recommendations for concrete in various sulfate exposures. When durability does not control, the w/cm ratio should be selected on the basis of concrete strength. In such cases, the w/cm ratio and mixture proportions for the required strength should be based on adequate field data or trial mixtures made with actual job materials to determine the relationship between the ratio and strength. A w/cm ratio below about 0.38 is not recommended for slipform paving. The type of SCMs should be known and accounted for when selecting the w/cm ratio.

Step 3: Aggregates

The quantity (bulk volume) of coarse aggregate can be estimated using Figure 7-6.

The bulk volume values in the legend are based on aggregates in a dry-rodded condition (ASTM C29/AASHTO T 19). These aggregates are suitable for producing concrete with a moderate workability fit for general concrete construction. For low-slump concrete (slipform paving), the bulk volume may be increased by about 10 percent.

Following is a list of key considerations when evaluating local aggregates:

- The largest maximum size consistent with the requirements for placing the concrete will produce the most economical concrete with the least tendency to crack due to thermal effects or autogenous, plastic, or drying shrinkage.
- The maximum size should generally not exceed one-fourth the thickness of the pavement or 2.5 in., whichever is less.

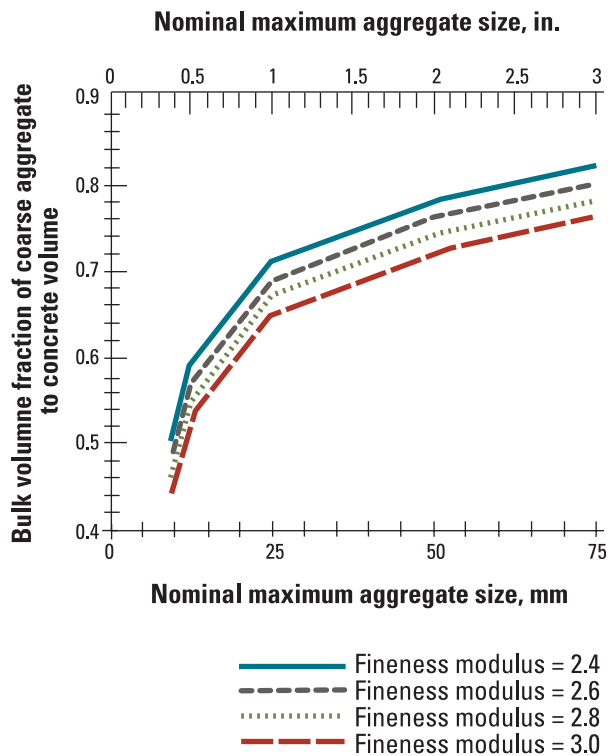

Adapted from ACI 211.1 and Hover 1995

Figure 7-6. Bulk volume of coarse aggregate per unit volume of concrete

- In areas where D-cracking in pavements is known to be a problem, a smaller maximum size may help mitigate the problem. Testing at the reduced maximum size is advisable.
- Aggregates should contain no more than the specified percentages of deleterious materials listed in ASTM C33/AASHTO M 6/M 43 or in the contract specifications.

Step 4: Air Content

Concrete that will be exposed to cycles of freezing and thawing should be adequately air entrained. The amount of air required (Figure 7-7) is a function of the severity of exposure and the maximum size of aggregate used in the concrete. Testing for spacing factors by Super Air Meter (SAM) or ASTM C457 will give better assurance of freeze-thaw durability.

The air content in job specifications should be specified to be delivered within -1 to +2 percentage points of the target value for moderate and severe exposures.

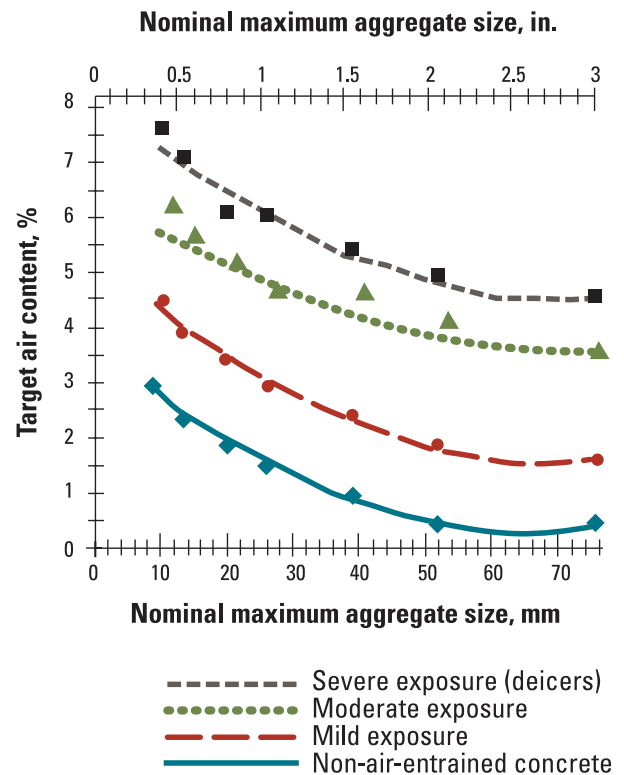

Adapted from ACI 211.1 and Hover 1995

Figure 7-7. Target total air content requirements for concretes using different sizes of aggregate

Step 5: Workability/Slump

Concrete must always be made with workability, consistency, and plasticity suitable for job placement conditions. The slump test is used to measure concrete consistency.

However, slump is only indicative of workability when assessing similar mixtures and should not be used to compare mixtures of significantly different proportions. In addition, the slump test is not a true indicator of acceptable concrete for slipform paving, and the VKelly or Box test provide a better indication of response to vibration. Workability must be ensured for the given mixture characteristics, the project paving equipment, and expected ambient conditions at time of paving.

Step 6: Water Content

The amount of water required in a concrete mixture depends on several factors:

- Aggregate size, texture, and shape
- Air content
- Amount and type of cementitious material
- Temperature of the concrete
- Slump requirements of the job

Water content can be reduced by incorporating water-reducing admixtures (see [Water Reducers in Chapter 4](#)).

For batch adjustments, the slump is typically increased by about 1 in. (by adding 10 lb of water per cubic yard). The water content required for air-entrained concrete can be determined from Figure 7-8. For some concretes and aggregates, the water estimates can be reduced by approximately 20 lb for subangular aggregate, 35 lb for gravel with some crushed particles, and 45 lb for rounded gravel to produce the slumps shown. This illustrates the need for trial batch testing of local materials because each aggregate source is different and can influence concrete properties differently.

See ACI 211.1 for the requirement for non-air-entrained concrete. Air-entrained concrete has a lower water demand than non-air-entrained concrete, which allows the quantity of mixture water required for a given level of durability to be reduced. (Rule of thumb: Decrease water by 5 lb/yd³ for each 1 percent decrease in air.)

(For requirements regarding water quality, including the use of recycled water, see [Water in Chapter 4](#).)

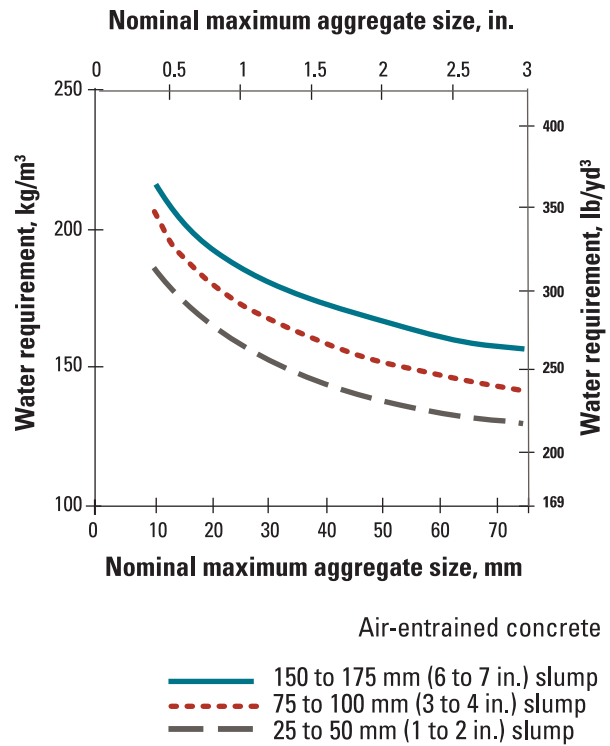

Adapted from ACI 211.1 and Hover 1995

Figure 7-8. Approximate water requirement for various slumps and crushed aggregate sizes for air-entrained concrete

Step 7: Cementitious Materials Content

The cementitious content is calculated by dividing the water content by the w/cm ratio.

$$\text{Cementitious Materials Content} = \frac{\text{Required Water Content}}{w/cm \text{ Ratio}}$$

Step 8: Cementitious Materials Type

Note: Mixture designers may do this step first because the type of cementitious materials selected can affect the previous seven steps.

The cementitious materials are selected to meet any special requirements, like sulfate resistance, ASR, or low-heat requirements. Fly ash reduces water demand, silica fume (and to a lesser effect metakaolin) increases it, and slag cement has a minimal effect on water demand.

Changes in the volume of cementitious material components due to different specific gravities (e.g., portland cement = 3.15 and fly ash = ~2.6) should be considered. SCMs also change the relationship between the w/cm ratio and strength.

Step 9: Admixtures

The quantities of admixtures are calculated to provide the required air- and water-reducing effect. Consideration must also be given to ensuring that the chloride limits for reinforced concrete are not exceeded when using chloride-containing admixtures as accelerators.

Incorporating certain chemical admixtures will result in changes to the water requirement or the air content of concrete (see [Set-Modifying Admixtures in Chapter 4](#)):

- Water reducers typically decrease water requirements by 5 to 10 percent and may increase air content by up to 1 percent.
- Calcium chloride-based admixtures reduce water requirements by about 3 percent and increase air by up to 0.5 percent.
- Retarding admixtures may increase air content.

Step 10: Fine Aggregate

Fine aggregate amount is determined after the quantities of coarse aggregate, air, water, and cementitious materials are known.

In the absolute volume method, these quantities are converted to volumetric proportions using the appropriate specific gravity (relative density) of the material. These volumes are then subtracted from a unit volume (1 ft³/1 yd³) to give the required volume of sand.

The volume of sand is then converted to a mass proportion using its specific gravity. If the combined aggregate grading has been optimized (see [Aggregate Grading Optimization earlier in this chapter](#)), then the sand quantity calculated here must be checked against the amount indicated by the optimization calculation.

Step 11: Moisture/Absorption Correction

Corrections are needed to compensate for moisture in and on the aggregates. In reality, aggregates will contain some measurable amount of moisture. The dry-batch weights of aggregates, therefore, need to be increased to compensate for the moisture that is absorbed in and contained on the surface of each particle and between particles. The mixing water added to the batch must be adjusted by the amount of moisture contributed or required by the aggregates, depending on their moisture state. The magnitude of the water correction should be equal to the correction made to the aggregate; the overall mass of material in a unit volume must remain unchanged.

Consider the following example of aggregate moisture correction: A particular mixture design calls for 1,800 lb/yd³ of dry fine aggregate. The measured absorption of the aggregate is 1.8 percent by mass of sample, and the in-storage aggregate moisture content is 2.8 percent. Therefore, the aggregate contains 1 percent of water above the amount the aggregate absorbed. To determine the amount of water that must be withheld from the batch, multiply 1 percent by 1,800 lb: 18 lb.

Step 12: Trial Batches

At this stage, the estimated batch weights should be checked through laboratory trial batches and full-size field batches. Enough concrete must be mixed for appropriate air and slump tests and for casting the cylinders required for prequalification tests. The batch proportions are multiplied by the volume of the batch required to produce the actual quantities required for mixing (see [Laboratory Mixtures under Pre-Construction earlier in this chapter](#)).

Adjusting Properties

Key Points

Chapter 6 describes the properties (and related tests) that are required to achieve a desirable concrete mixture and a durable concrete pavement. This section outlines a number of adjustments that can be made to a mixture to achieve these properties. Adjustments may include changes in the materials selected or in their proportions.

Sometimes, the required properties may impose mutually exclusive demands on the mixture design. Mixture proportioning is a series of decisions to find the best compromise among competing needs. In this chapter and throughout the manual, therefore, suggestions to adjust mixture proportions to obtain certain properties must be taken in a general context; they are not appropriate for every mixture. Decreasing cement content, for example, may be generally desirable in order to minimize paste content and thus minimize heat and shrinkage, but it may negatively affect other specific performance requirements for a particular mixture.

Workability

Fresh concrete mixtures must possess the workability, including mobility, compactability, stability, and freedom from segregation, required for the job conditions (Kosmatka and Wilson 2016, Mindess et al. 2003). The following can be adjusted to achieve the desired workability (Scanlon 1994, Mindess et al. 2003):

- **Water content:** Increasing the water content of concrete will generally increase the ease with which the concrete flows. However, increased water content will reduce the strength and increase the permeability of the hardened concrete and may result in increased segregation. Shrinkage also increases with increased water content.
- **Proportion of aggregate and cement:**
 - In general, an increase in the aggregate-to-cement ratio will reduce workability.
 - As the aggregate grading becomes finer, more cement is required to maintain the same consistency.

- Mixtures containing too little cement are often harsh; whereas, mixtures rich in cement are generally more workable but may become sticky and difficult to finish.
- Mixtures deficient in fine aggregate will be harsh, prone to segregation, and difficult to finish; whereas, mixtures made with an excess of fine aggregate are typically more permeable and less economical.
- The use of finer sand will also reduce workability unless water content is increased; whereas, concrete made with coarse sand is often difficult to finish.

- **Aggregate properties:** In general, the more spherical the aggregate, the more workable the concrete, due to a reduction in mechanical interlock that occurs with angular particles. A high degree of flat and/or elongated coarse aggregate particles will reduce workability, as will the use of rough-textured aggregate versus smooth aggregate.
- **Cement characteristics:** Although less important than aggregate properties, finer cement (e.g., Type III) reduces workability at a given water/cement ratio.
- **Admixtures:** The use of air-entraining admixtures (AEAs) will increase workability by creating small, spherical bubbles that act as ball bearings in the fresh concrete. As the name implies, water-reducing admixtures will also increase workability if other mixture design parameters are not changed. Pozzolans and finely divided materials, including inert, cementitious materials, generally improve workability when used to replace part of the sand instead of the cement.
- **Time and temperature:** As ambient temperature increases, workability decreases. Yet over short periods of time, temperature appears to have little effect. Workability decreases with time as hydration proceeds. Any improvements in workability achieved through the use of water-reducing admixtures are often relatively short lived.

Stiffening and Setting

The rates of stiffening and setting of a concrete mixture are critically important for the contractor because those rates will directly influence its ability to be placed, finished, and sawed without surface blemishes and cracking.

Both stiffening and setting can be affected by the following in the concrete mixture:

- **Cementitious materials**—The rate of stiffening and setting of a concrete mixture will be primarily controlled by the cement content, chemistry, and fineness. Generally, setting is delayed with increasing dosages of slag cement and fly ash, although the presence of tricalcium aluminate (C₃A) in some fly ashes may result in false set, particularly at elevated temperatures. It is important to make trial mixtures using the materials available at the plant to check for incompatibility (see [Potential Materials Incompatibilities in Chapter 5](#)).
- **Chemical admixtures**—Chemical retarders and accelerators are available to assist with controlling set time, but they generally do not influence the rate of slump loss. Some chemical admixtures may react with some cements or SCMs to cause early stiffening.
- **Aggregate moisture**—If aggregates are below saturated surface dry (SSD) when the mixture is batched, water absorbed into the aggregate will cause slump loss. The amount of water added during batching must be adjusted for the moisture conditions of the aggregates in order to meet the water requirement of the mixture design and keep a constant w/cm ratio (see [Step 11 under The Absolute Volume Method before this](#)). Ideally, aggregates should be at or near an SSD state.
- **Temperature**—The higher the temperature, the shorter the setting time and the higher the risk of incompatibility issues. Use chilled water, ice, or liquid nitrogen to reduce the mixture temperature to 60°F to 70°F where possible.
- **W/cm ratio**—A lower w/cm ratio reduces set time.

Bleeding

[Bleeding](#), as described in [Chapter 6](#), is the development of a layer of water on the surface of freshly placed concrete. Bleeding is caused by the settlement of cement and aggregate particles in the mixture and the simultaneous upward migration of water (Kosmatka and Wilson 2016).

A number of techniques can be used to prevent or minimize bleeding in the mixture design stage, including the following (Kosmatka 1994):

- Reducing the water content, w/cm ratio, and slump
- Proportioning of aggregate and cement
- Increasing the amount of cement or SCMs in the mixture (resulting in a reduced w/cm ratio)
- Increasing the fineness of the cementitious materials
- Using properly graded aggregate
- Using certain chemical admixtures such as air-entraining agents

Air-Void System

The air-void system of concrete is fundamentally important to the durability of concrete in environments subject to freezing and thawing. It includes total air content, spacing factors, and the specific surface.

The air-void system in a concrete mixture can be controlled with the following adjustments (Whiting and Nagi 1998):

- **Cement**—Increasing alkali content and decreasing fineness in a cement is likely to result in increased entrained air.
- **SCMs**—Increasing the carbon (loss on ignition [LOI]) content of fly ash will rapidly reduce the amount of air entrained for a given AEA dosage. Small variations in a fly ash composition may result in large swings in the air content, making production of uniform concrete difficult. The use of slag cement or silica fume may require the use of an additional AEA to achieve the desired air content.
- **Aggregates**—Increasing the amount of material retained on the #30 to #50 sieves will result in increased air entrainment.
- **Workability**—Increasing workability will result in increased air content for a given concrete mixture.

Trial batching prior to the start of the job will indicate the air contents expected with the job-specific materials, batching sequence, and mixture time and speed. However, the air-void system in the field will be affected by the following factors:

- **Changes in the grading of the aggregates**—The air content requirement decreases with an increase in large-size aggregate, and air content increases with an increased fine aggregate content, especially with an increase in the #30 to #50 sizes.
- **Water**—Air content increases with extra water.
- **Admixture dosage**—Air content increases with an increase in water-reducing and retarding admixtures based on lignin.
- **Delays**—Some air loss is expected during delivery and with time.
- **Temperature**—An increase in temperature will require an increase in the amount of AEA to maintain the target air content (Whiting and Nagi 1998).

Density (Unit Weight)

Conventional concrete, normally used in pavements, has a density (unit weight) in the range of 137 to 150 lb/ft³. The density of concrete varies, depending on the amount and density of the aggregate, the amount of air entrapped or purposely entrained, and the water and cement contents, which in turn are influenced by the maximum size of the aggregate. Density is a useful indicator of batching uniformity and consolidation. Density is affected by the following factors:

- Density of the material in the mixture, with the most influence from the coarse aggregate
- Moisture content of the aggregates
- Air content of the mixture
- Relative proportions of the materials, particularly water

The density (unit weight) and yield of freshly mixed concrete are determined in accordance with ASTM C138 (AASHTO T 121) (see Unit Weight in Chapter 9). The results should be sufficiently accurate to determine the volumetric quantity (yield) of concrete produced per batch. The test can also indicate air content, provided the relative densities of the ingredients are known.

Strength

The pavement designer establishes the concrete strength requirement that meets the intent of the design. Strength and rate of strength gain are influenced by the following factors:

- **W/cm ratio**—Reducing the w/cm ratio will increase strength.
- **Cement chemistry**—Cements with high alkali and tricalcium silicate, or alite (C₃S), contents and high fineness will tend to gain strength more quickly, although long-term strengths may be slightly reduced.
- **Cementitious materials**—Slag cement and Type F fly ash may reduce early strength gain, but they will normally result in higher long-term strengths.
- **Chemical admixtures**—Water reducers that effectively decrease the w/cm ratio will result in increased strengths. Retarders may reduce early strengths but increase long-term strengths.
- **Aggregates**—Optimizing aggregate grading will help reduce the water requirement of the system with a consequent strength increase. Using crushed coarse aggregates and increasing coarse aggregate size will increase flexural strengths.
- **Temperature**—Increasing temperature will increase early strengths and decrease long-term strengths.

It should be noted that for a given w/cm ratio, adjusting cementitious content will have little effect on strength at 28 days or beyond. Increasing cementitious content may be required to achieve very early strengths or to limit the risks of early age cracking in cold weather.

During construction, changes in the environmental conditions and variations in materials, consolidation, and curing affect the strength at a specified age and affect strength development with age. Increased temperatures will increase early strength but may suppress long-term strength gain.

Quality control measures will indicate whether the strength gain is as expected. Generally, the strength gain of the specimens sampled and cured in a standard manner is determined, which indicates the potential of the mixture. However, the strength gain of the in-place concrete is also very important, and test procedures are available to estimate that.

Volume Stability

Concrete experiences volume changes (i.e., shrinkage/contraction or expansion) as a result of temperature and moisture variations.

To minimize the risk of cracking, it is important to minimize the change in volume by considering the following:

- **Paste content**—The most important controllable factor affecting drying shrinkage is the amount of water per unit volume of concrete. Shrinkage can be minimized by keeping the paste content of concrete as low as possible without compromising other required properties.
- **Aggregates**—Avoid aggregates that have high drying shrinkage properties and aggregates that contain excessive amounts of clay. Quartz, granite, feldspar, limestone, and dolomite aggregates generally produce concretes with low drying shrinkage (ACI Committee 224). Aggregate selection will also have the greatest influence on thermal expansion.
- **Curing**—The longer and more effective the curing practices, the lower the shrinkage will be. Good curing will also allow the concrete to gain more strength and thus be better able to resist the shrinkage stresses and reduce the risk of cracking.

Permeability and Frost Resistance

Permeability is a direct measure of the potential durability of a concrete mixture.

Lower permeability can be achieved by making the following adjustments:

- Reducing the w/cm ratio
- Using SCMs at appropriate dosages
- Using good curing practices
- Using materials resistant to the expected form of chemical attack (e.g., slag cement is preferred for chloride penetration, while Class F fly ash can improve sulfate resistance)
- Using aggregates that have a proven history of resistance to D-cracking (reducing maximum coarse aggregate size will slow the rate of damage if aggregates prone to damage are unavoidable)
- Ensuring that a satisfactory air-void system is provided in the concrete

Abrasion Resistance

Abrasion resistance is required to reduce the risk of polishing and thus maintain skid resistance, especially where studded tires or chains are used. This can be improved with the following adjustments:

- Choose hard, dense, siliceous fine aggregates
- Increase compressive strength
- Increase the curing time

Sulfate Resistance

Sulfate attack is a problem when concrete is exposed to substrates that have high sulfate contents. Resistance to such attacks can be improved by making the following adjustments:

- Reduce the w/cm ratio to reduce permeability
- Use a sulfate-resisting cement (ASTM C150 Type II, or for more resistance Type V; ASTM C595 Types IP[MS], IS[MS], I[PM][MS], I[SM][MS], or P[MS]; or ASTM 1157 Types MS or HS)
- Use Class F fly ash (15 to 25 percent)
- Use 20 to 50 percent slag cement for moderate sulfate resistance
- Use a higher percent of SCMs through ternary mixtures

Alkali-Silica Reaction

Deleterious expansion of pavements due to alkali-silica reaction can be a serious problem. Reduction of this reaction can be achieved by making the following adjustments:

- Use aggregates that have a history of satisfactory performance
- Use low-alkali cement (Using low-alkali cements may not mitigate all situations)
- Use SCMs, which have been shown to reduce the expansion of a given system
- Use lithium admixtures
- Possibly blend reactive aggregate with nonreactive aggregate

A protocol to control potential ASR is published in AASHTO R80.

References

- AASHTO M 6 *Specification for Fine Aggregate for Hydraulic Cement Concrete.*
- AASHTO M 43 *Standard Specification for Sizes of Aggregate for Road and Bridge Construction.*
- AASHTO PP 84-18 *Standard Practice for Developing Performance Engineered Concrete Pavement Mixtures.*
- AASHTO T 19 *Standard Method of Test for Bulk Density ("Unit Weight") and Voids in Aggregate.*
- AASHTO T 23 *Standard Method of Test for Making and Curing Concrete Test Specimens in the Field.*
- AASHTO T 119 *Standard Method of Test for Slump of Hydraulic Cement Concrete.*
- AASHTO T 121 *Standard Method of Test for Density (Unit Weight), Yield, and Air Content (Gravimetric) of Concrete.*
- ASTM C29 *Standard Test Method for Bulk Density ("Unit Weight") and Voids in Aggregate.*
- ASTM C31 *Standard Practice for Making and Curing Concrete Test Specimens in the Field.*
- ASTM C33 *Standard Specification for Concrete Aggregates.*
- ASTM C138 *Standard Test Method for Density, Yield, and Air Content of Concrete.*
- ASTM C143 *Test Method for Slump of Hydraulic Cement Concrete.*
- ASTM C150 *Standard Specification for Portland Cement.*
- ASTM C457 *Test Method for Microscopical Determination of Parameters of the Air-Void System in Hardened Concrete.*
- ASTM C595 *Standard Specification for Blended Hydraulic Cements.*
- ASTM C1157 *Standard Performance Specification for Hydraulic Cement.*
- ACI. 2002. *Building Code Requirements for Structural Concrete and Commentary.* ACI 318-02. American Concrete Institute, Farmington Hills, MI.
- . 2005. *Building Code Requirements for Structural Concrete.* ACI 318-05. American Concrete Institute, Farmington Hills, MI.
- ACI Committee 211. 1991. *Standard Practice for Selecting Proportions for Normal, Heavyweight and Mass Concrete.* ACI 211.1-91. American Concrete Institute, Farmington Hills, MI.
- ACI Committee 224. 2001. *Control of Cracking in Concrete Structures.* ACI 224R-01. American Concrete Institute, Farmington Hills, MI.
- ACI Committee 301. 1999. *Specifications for Structural Concrete.* ACI 301-99. American Concrete Institute, Farmington Hills, MI.
- ACI Committee 302. 1996. *Guide for Concrete Floor and Slab Construction.* ACI 302.1R-96. American Concrete Institute, Farmington Hills, MI.
- Cook, D., A. Ghaeezadeh, and T. Ley. 2013. *Investigation of Optimized Graded Concrete for Oklahoma.* Oklahoma Transportation Center, Midwest City, OK.
- Hover, K. 1994. Air Content and Unit Weight of Hardened Concrete, *Significance of Tests and Properties of Concrete and Concrete-Making Materials.* STP 169C-EB. ASTM International, West Conshohocken, PA, pp. 296–314.
- Hover, K. 1995. Graphical Approach to Mixture Proportioning by ACI 211.1-91. *Concrete International*, Vol. 17, No. 9, pp. 49–53.
- Kosmatka, S. H. 1994. Bleeding. Chapter 12 in *Significance of Tests and Properties of Concrete and Concrete Making Materials.* American Society for Testing and Materials, West Conshohocken, PA. pp. 88–111.
- Kosmatka, S. H. and M. Wilson. 2016. *Design and Control of Concrete Mixtures.* 16th Edition. Portland Cement Association, Skokie, IL.
- Mindess, S., J. F. Young, and D. Darwin. 2003. *Concrete.* Second Edition. Prentice Hall, Upper Saddle River, NJ.
- Scanlon, J. M. 1994. Factors Influencing Concrete Workability. Chapter 8 in *Significance of Tests and Properties of Concrete and Concrete Making Materials.* American Society for Testing and Materials, West Conshohocken, PA. pp. 49–64.
- Shilstone, J. M., Sr. 1990. Concrete Mixture Optimization. *Concrete International*, Vol. 12, No. 6, pp. 33–39.
- Wang, X., P. Taylor, E. Yurdakul, and X. Wang. 2018. An Innovative Approach to Concrete Mixture Proportioning. *ACI Materials Journal*, Vol. 115, No. 5, pp. 749–759.
- Whiting, D. and M. A. Nagi. 1998. *Manual on the Control of Air Content in Concrete.* Portland Cement Association, Skokie, IL.

Chapter 8

Construction

Introduction	202
Subgrades	202
Bases	206
Concrete Paving	209
References	241

Introduction

While good-quality concrete pavement is strongly influenced by the mixture, as discussed in the other chapters of this manual, other significant factors include the quality of the foundation system that the concrete is placed on and the construction practices used to place it. These are the subjects of this chapter.

A common cause of distress in a pavement is failure of the support system below the pavement. It is important that a concrete pavement be provided with suitable support that is uniform, level, and able to carry the loads imposed. Before the concrete pavement is placed, the subgrade must be properly prepared and compacted.

On top of this, a base is usually constructed. It is also essential to pay attention to the levelness or grade of the base. Concrete on a base with irregular grades will have variable thickness, potential thin spots, and a tendency toward roughness. This roughness is related to bumps and dips in the foundation layer(s). Subbase friction and its impact on saw timing and cracking potential is addressed in [Chapter 6](#) and later in this chapter under [Crack Prediction with HIPERPAV](#).

The other significant requirement is to use appropriate, high-quality equipment and good practices. Failures in construction are often due to a combination of marginal materials used in marginal equipment operated by insufficiently trained operators. Long-term performance of concrete pavements is highly dependent on the foundation layer(s). Similar to the use of a durable concrete mixture, this aspect of design and construction should be given appropriate attention.

Subgrades

Key Points

- The subgrade is the lowest layer of the roadbed and consists of natural ground and/or imported materials, graded and compacted, on which the pavement is built.
- A uniform and stable subgrade is required for long-term durability of the pavement. (In general, subgrade uniformity and stability are more important than subgrade strength for pavement performance.)
- Three major causes of subgrade instability—expansive soils, frost action, and pumping—are leading to concentrated stresses in the pavement and must be controlled.
- Pavement subgrades may need to be improved temporarily (soil modification) or permanently (soil stabilization) through the use of additives or binders.

The subgrade is the lowest layer of the roadbed and consists of natural ground and/or imported materials, graded and compacted, on which the pavement is built. Subgrade uniformity and stability affect both the long-term performance of the pavement and the construction process. Requirements for subgrade preparation may vary considerably, depending on soil type, environmental conditions, and amount of heavy traffic. In any case, the objective is to obtain uniform support for the pavement that will prevail throughout its service life. Softening of the subgrade over time can reduce the life of a concrete pavement; therefore, it is important to design and construct them in a manner that will keep them drained and long lasting.

Preparation of the subgrade includes the following activities:

- Compacting soils at moisture contents and densities that will ensure uniform and stable pavement support
- Whenever possible, setting grade lines high enough and making side ditches deep enough to increase the distance between the water table and the prepared subgrade
- Cross-hauling and mixing soils to achieve uniform conditions in areas where there are abrupt horizontal changes in soil types

- Using selective grading in cut and fill areas to place the better soils nearer to the top of the final subgrade elevation
- Improving extremely poor soils by treating them with lime, cement, cement kiln dust, or fly ash, or by importing better soils, whichever is more economical
- Using geotextile grids to improve the load-bearing capacity of the soils

Uniform Support

Due to its rigid nature, a concrete pavement with sufficient load transfer distributes the pressure from applied loads over a larger area of the supporting material. As a result, midslab deflections are small and pressures on the subgrade are low (ACPA 1995). Concrete pavements, therefore, do not require especially strong foundation support.

More important than a strong foundation is a uniform foundation. The subgrade should have a uniform condition, with no abrupt changes in the degree of support (Figure 8-1).

There should be no hard or soft spots. Nonuniform support increases localized deflections and causes stress concentrations in the pavement. Localized deflections and concentrated stresses can lead to premature failures, fatigue cracking, faulting, pumping, and other types of pavement distress.

Providing reasonably uniform support conditions beneath the concrete slab requires controlling three major causes of subgrade nonuniformity:

- Expansive soils
- Frost action
- Pumping

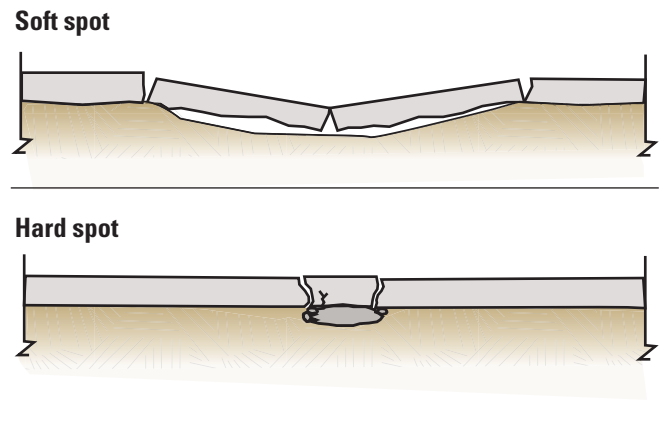

Farny 2001, PCA, used with permission

Figure 8-1. Effects of two examples of nonuniform support on concrete slabs on the ground

Expansive Soils

Excessive differential shrinkage and swelling of expansive soils can cause nonuniform subgrade support. As a result, concrete pavements may become distorted enough to impair riding quality. Several conditions can lead to expansive soils becoming a problem under concrete pavements:

- The expansive soils were compacted too dry or allowed to dry out before paving.
- The expansive soils have widely varying moisture contents, leading to subsequent shrinkage and swelling.
- There are abrupt changes in soil types and associated volume-change capacities along the project.

The key to minimizing the effects of potentially expansive soils is to identify and treat them early in the process. Table 8-1 lists simple index tests that can be performed to determine the potential for expansion in soils.

Table 8-1. Soil index properties and their relationships to potential for expansion

Degree of expansion	Data from index tests*			Estimation of probable expansion,** percent total volume change (dry to saturated condition)
	Plasticity index, percent (ASTM D4318)	Shrinkage limit, percent (ASTM D427)	Colloid content, percent minus 0.001 mm (ASTM D422)	
Very high	> 35	< 11	> 28	> 30
High	25 to 41	7 to 12	20 to 31	20 to 30
Medium	15 to 28	10 to 16	13 to 23	10 to 20
Low	< 18	> 15	< 15	< 10

* All three index tests should be considered in estimating expansive properties.

** Based on a vertical loading of 1.0 lb/in². For higher loadings, the amount of expansion is reduced, depending on the load and the clay characteristics.

Source: After Bureau of Reclamation 1998

Procedures such as those in ASTM D1883, ASTM D3152, ASTM D4546, ASTM D4829, and CALTRANS Test 354 are especially suitable for evaluating the volume change of subgrade soils. Some factors determined by these tests that are not indicated by the simple index tests are the following:

- The effect of compaction moisture and density on soil swell characteristics
- The effect of surcharge loads
- Expansion potential for the overall soil grading rather than for only a sample of the finer grading fraction of the soil

Frost Action

Frost action includes the effects of both frost heave and subgrade softening. However, only frost heave is a consideration for concrete pavements. Field experience has shown that subgrade softening, which occurs in the spring in many areas of the US, is not a design factor because strong subgrade support is not required under concrete pavements. Concrete pavement reduces pressure on the subgrade layers by distributing applied traffic loads over large areas. Concrete pavements designed for typical subgrade conditions will have ample reserve capacity for the two to three weeks of the spring softening of the subgrade.

Frost heave occurs when ice lenses form in the soil, which continue to attract water and expand further. The heaving itself is not a problem for concrete pavements; rather, it is the subsequent thawing and differential settling of the concrete slabs that can lead to roughness and/or cracking.

For frost heave to occur, all three of the following conditions must be present:

- A frost-susceptible soil
- Freezing temperatures that penetrate the subgrade
- A supply of water

Controlling any one of the three conditions will dramatically reduce the potential for frost heave.

The degree of frost susceptibility of a particular soil is related to its capillarity, or suction, and its permeability (Figure 8-2).

Low-plasticity, fine-grained soils with a high percentage of silt particles (0.0002 to 0.002 in.) are particularly sensitive to frost heave. These soils have pore sizes small enough to develop capillary potential and large enough

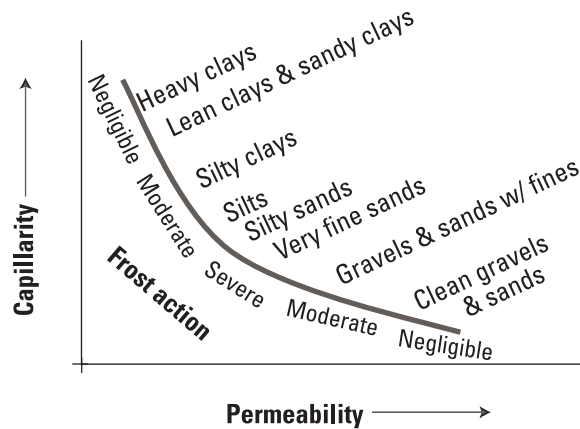

After ACPA 1995, used with permission

Figure 8-2. Relationship between frost action and hydraulic properties of soils

to permit water to travel to the frozen zone. Coarser soils accommodate higher rates of flow, but they lack the capillary potential to lift moisture from the water table. Although more cohesive soils have high capillarity, they have low permeability, limiting movement of sufficient water that would form ice lenses in the soil.

Pumping

Pumping is the forceful displacement of a mixture of soil and water (i.e., mud) from underneath a concrete pavement during application of heavy loads. Continued, uncontrolled pumping eventually leads to the displacement of enough soil so that uniformity of the subgrade is destroyed, which can result in cracking, faulting, and settling of the concrete pavement.

Three factors are necessary for pumping to occur:

- Pump-susceptible material beneath the slab
- Free water between the pavement and subgrade or base
- Rapid and large deflections of the pavement slabs

Controlling any one of these three factors by providing good load transfer between panels and well-drained support using appropriate materials will dramatically reduce the potential for pumping.

Grading and Compaction

Grade preparation lays the foundation for the entire pavement structure. The uniformity and stability of the subgrade affect both the long-term performance of the pavement and the rest of the construction process. The important elements of subgrade preparation include evaluating subgrade stability and uniformity, modifying the subgrade to improve stability, and evaluating surface tolerances.

Pre-Grading

The first step in preparing the subgrade is to determine areas for cross-hauling and mixing of soil types to establish uniformity. Silt pockets can be removed, and expansive soils can be placed in lower parts of embankments to reduce swell potential. Mass grading is accomplished in this phase, which involves cutting high points and filling low spots to roughly achieve the desired alignment.

Moisture-Density Control

Subgrade volume changes are reduced by adequate moisture and density control during compaction. Expansive and frost-susceptible soils should be compacted at 1 to 3 percent above optimum moisture using ASTM D698/AASHTO T 99.

Improving Soil Characteristics

Pavement subgrades may need to be improved for a number of reasons:

- To improve low-strength soil
- To reduce swelling potential
- To improve construction conditions

Subgrades may be improved through the use of additives or binders. Commonly used materials for soil improvement include cement, cement kiln dust, lime, lime kiln dust, and fly ash. Which material is used and at what addition rate depends on the type of soil, amount of stability desired, and length of time necessary. If the subgrade support is needed only during the construction phase to support construction vehicles, the process is termed “soil modification.” If the support is intended to be permanent and function as a supportive layer to the pavement, the process is termed “soil stabilization.” Certain techniques, additives, or addition rates lend themselves to temporary soil modification, while others are often used for the more permanent soil stabilization.

For more information on soil modification and stabilization, refer to the *Guide to Cement Stabilized Soil for Subgrades*, available at <https://cptechcenter.org/publications/> under the Guides/Manuals category.

Trimming

Once the subgrade has been compacted to the desired density at the proper moisture level and/or treated to reduce expansion potential, it is trimmed to the proper grades, elevations, and cross slopes. This can be performed using a trimming machine (Figure 8-3), 3D machine control, or a motor grader using 3D machine control.



GOMACO Corporation, used with permission

Figure 8-3. Trimming subgrade material

For fixed-form construction, an automatic trimmer can ride on the forms after they are fastened into place. For smaller projects or pavements without a smoothness specification, the grade is not typically trimmed according to a string line, but it is graded with a motor grader or small loader and then spot-checked from survey hubs set approximately 50 ft apart (ACPA 2003a).

Proof-Rolling

Proof-rolling can locate isolated soft areas that are not detected in the grade inspection process. It involves driving a heavy, pneumatic-tired vehicle over the prepared grade while observing for rutting or deformation. A fully loaded tandem axle truck or rubber-tired loader may be used as the proof-roller. Steel drum rollers are not recommended because they may potentially distribute the load across soft areas without any observed movement. Proof-rolling is recommended if an unstabilized base is to be used between the concrete pavement and subgrade.

Intelligent Compaction

The use of intelligent compaction equipment provides feedback to the contractor and engineer on the support condition provided by the subgrade. In contrast to spot moisture and density checks, intelligent compaction feedback covers 100 percent of the subgrade, so isolated areas of weakness can be identified and mitigated before successive base layers are placed. Comprehensive guidance on the use of intelligent compaction can be found here: http://www.intelligentcompaction.com/downloads/Reports/FHWA-TPF_IC_Final_Report.pdf.

Bases

Key Points

- A base is defined as the layer of material that lies immediately below the concrete pavement.
- Bases may be constructed of granular materials, cement-treated materials, lean concrete, hot-mixed asphalt, or open-graded, highly permeable materials, which may be stabilized or unstabilized.
- As with subgrades, the most important characteristics of a base are uniformity and adequate support.
- Balance must be achieved between the degree of drainage and the stability of the base layer. Stability should not be sacrificed for the sake of drainage.

Under certain conditions, such as expected heavy traffic or poor-quality subgrades, a base layer is needed on top of the prepared subgrade and immediately below the concrete pavement. The material quality requirements for a base under concrete pavement are not as strict as those for a base under asphalt pavement because the pressures imposed on a base under concrete are much lower than those under asphalt.

For light-traffic pavements, such as residential streets, secondary roads, parking lots, and light-duty airports, placed on uniform and nonexpansive soils, the use of a base layer is not required. However, the desired results can only be obtained with proper subgrade preparation techniques and adequate inspection. The use of a base course is typically encouraged except where the in situ soils can provide the necessary support and are readily compacted at the proper moisture content.

Types of Bases

Bases may be constructed of granular materials, cement-treated materials, lean concrete, hot-mixed asphalt, or open-graded, highly permeable materials, which may be stabilized or unstabilized.

When the use of a base is considered appropriate, the best results are obtained by following these guidelines:

- Select base materials that meet minimum requirements for preventing pumping of subgrade soils

- Specify grading controls that will ensure a reasonably constant base grading for individual projects
- Specify base layers with a thickness ≥ 4 in. and ≤ 8 in.
- Specify a minimum density for untreated bases of 105 percent of ASTM D698/AASHTO T 99 for heavily traveled projects
- Specify a treated base that provides a strong and uniform support for the pavement and joints, provides an all-weather working platform, and contributes to smoother pavements by giving firm support to the forms or paver during construction

Unstabilized (Granular) Bases

A wide variety of materials and gradings has been used successfully by different agencies for untreated bases. These materials include crushed stone, crushed concrete, bank-run sand-gravels, sands, soil-stabilized gravels, and local materials such as crushed mine waste, sand-shell mixtures, and slag.

The principal criterion is to limit the amount of fines passing a #200 sieve to less than 10 percent. Soft aggregates should be avoided because fines may be created due to the abrasion or crushing action of compaction equipment and construction traffic. Generally, aggregates having less than 50 percent loss in the Los Angeles abrasion test (ASTM C131/AASHTO T 96) are satisfactory (see *Abrasion Resistance* in Chapter 6).

Stabilized (Treated) Bases

Stabilized or treated bases can be accomplished using hydraulic cement with or without supplementary cementitious materials (SCMs), or asphalt. Types of stabilized bases include cement treated, asphalt treated, lean concrete, asphalt treated open graded, and cement treated open graded. Such stabilized bases provide the following benefits:

- A stable working platform to expedite all construction operations and permit large daily production of concrete pavement with minimum downtime for inclement weather
- Firm support for slipform paver or side forms
- Construction of smooth pavements due to stable trackline of adequate width (typically 3 ft) for slipform pavers
- Prevention of base consolidation under traffic

- Reduction in pavement deflections from vehicle loadings
- Improved load transfer at pavement joints
- Minimized intrusion of hard granular particles into the bottom of pavement joints
- A more erosion-resistant base surface

Grading Control

The base for an individual project should have a reasonably constant gradation to allow compaction equipment to produce uniform and stable support, which is essential for good pavement performance. Abrupt changes in gradation of base materials can be nearly as harmful as abrupt changes in subgrade soils.

Compaction Requirements for Dense Graded Bases

To prevent the consolidation of granular materials from the action of heavy traffic once the pavements are in service, bases must be compacted to very high densities. Unstabilized bases under concrete pavements should have a minimum of 100 percent of ASTM D698/AASHTO T 99 density. For projects that will carry large volumes of heavy traffic, the specified density should not be less than 105 percent of standard density or 98 to 100 percent of ASTM D1557/AASHTO T 180 density.

Compaction Requirements for Permeable Bases

Unstabilized permeable bases do not require a specified density. They are typically compacted with three passes of a smooth drum roller to provide some stability as a working platform, yet still retain the permeable/drainable characteristics of the specified gradation.

Materials

Granular materials in AASHTO Soil Classification Groups A-1, A-2-4, A-2-5, and A-3 are used for cement-treated bases. They contain not more than 35 percent passing the #200 sieve, have a profile index (PI) of 10 or less, and may be either pit-run, manufactured, recycled concrete, or recycled asphalt. Cement-treated bases have been built with A-4 and A-5 soils in some nonfrost areas and are performing satisfactorily. Generally, however, such soils are not recommended for bases in frost areas or where large volumes of heavy truck traffic are expected. Use of A-6 and A-7 soils is not recommended. To permit accurate grading of the base, the maximum size of material is usually limited to 1 in. and preferably to $\frac{3}{4}$ in.

Econcrete or lean concrete bases are typically designed for a specific application and environment. In general, they use aggregates that do not necessarily meet quality standards for conventional concrete. A single aggregate rather than coarse and fine aggregates stockpiled separately is often used in the mixture. Cement content is less than what is used for normal concrete and is selected based on the target strength.

A common source of aggregate for any base type is crushed, recycled concrete. Existing concrete pavements can be removed, crushed, and reused in base courses, either as unstabilized aggregate bases or stabilized bases. The fractured concrete and fine material contain cement that will begin to hydrate and thereby provide some of the benefit of a stabilized base. Comprehensive guidance on the use of recycled concrete as an aggregate for unstabilized and stabilized bases is available in the *Recycling Concrete Pavement Materials: A Practitioner's Reference Guide* (Snyder et al. 2018).

Construction

Unstabilized bases can either be road mixed or plant mixed using a pugmill. The granular materials should be spread in a manner that minimizes segregation—shaped and compacted at the correct moisture content. Final trimming to grade is accomplished with a trimmer or motor grader.

Stabilized bases are predominantly plant mixed. For plant-mixed bases, the material can be mixed either in a pugmill, a central-mixed concrete plant, or an asphalt plant. The material is mixed and transported to the grade in trucks. Placement with a high-density asphalt paver is common (see Figure 8-4).

These pavers may achieve the specified density without further compactive effort; when necessary, a roller can be used to reach density.



ACPA, used with permission

Figure 8-4. High-density paver placing cement-treated base (CTB)

Econocrete or lean concrete bases are constructed in essentially the same manner and with the same equipment as conventional concrete pavements. They are mixed using a central-mixed concrete plant and placed using a slipform paver. The only differences are the jointing practice and the treatment of the surface of the lean-concrete base. Construction of joints in the lean-concrete base is not considered necessary as long as a debonding treatment is applied to the surface of the base.

Because there is a high potential for bonding of the concrete pavement to a cement-stabilized base, it is important that a bond-breaking medium be applied to the base surface. Current practice in the US includes applying two heavy coats of wax-based curing compound on the base surface (Okamoto 1994). Table 8-2 lists some alternative materials that may be used to reduce friction and prevent bonding of pavement concrete to base layers.

Bonding of the concrete pavement to a hot-mixed asphalt base is not an issue and can be beneficial because the asphalt has sufficient flexibility to prevent reflective cracking from occurring.

Drainage in the Base Layer

Pavement drainage is an important factor in pavement performance. In the past, many poorly designed pavements with little drainage failed because of water trapped within the pavement structure, leading to subgrade pumping, reduced subgrade and base strengths, and resulting pavement distresses.

A method of providing drainage in a pavement section is to specify a drainable or permeable base layer, using an open-graded aggregate grading. This layer can be

daylighted to the side ditches, or it can direct water to flow into edge drains.

The number of voids in the base has a direct relationship to the material's stability. Dense-graded granular materials and materials stabilized with cement or asphalt provide firm support for construction equipment and the concrete pavement. Unstabilized permeable bases or stabilized but highly permeable bases, which became popular in the 1990s, have caused some construction as well as performance problems, often related to initial quality or maintenance issues.

An important balance must be achieved between the degree of drainage and the stability of the base layer. Base stability should not be sacrificed for the sake of drainage. A target permeability of 200 to 300 ft/day produces a stable draining layer that will support the paving equipment and construction vehicles. Layers with higher permeability do not have the in-place stability necessary for construction and pavement performance.

Trackline

One of the most significant design considerations for obtaining a consistently smooth concrete pavement is provision of a stable, smooth trackline or pad-line (ACPA 2003a).

Tracklines are the paths along which a slipform paving machine's tracks will follow. They are usually 3 ft outside either edge of the concrete slab (Figure 8-5). Agencies that specify and pay for this extra 3 ft of base width on either side of the slab get the benefit of smoother pavements, as well as the additional support provided to the slab edges, shoulders, and curb-and-gutter sections.

Table 8-2. Alternatives for reducing friction or bond between concrete pavement and stabilized base materials

Material	Comments
Curing compound	Two coats of white-pigmented, wax-based compound (ASTM C309/AASHTO M 148) works well.
Geotextile fabric	Meeting AASHTO M 288.
Asphalt emulsion	Works well on smoother base surfaces. Must be an even coating.
Choker stone	For stabilized open-graded materials only. Chip-size material to fill near-surface voids and minimize penetration of concrete into base.

Source: Updated and revised from ACPA 2002



Figure 8-5. Trackline of slipform paving machine

Trimming to Grade

Like subgrades, unstabilized bases can be trimmed to grade. Econocrete (lean concrete) and asphalt bases are typically not trimmed after being placed, but they are instead constructed to the planned grade referenced from a string line or the trimmed subgrade surface. Care must be exercised, however, when trimming cement-treated bases. Trimming these types of bases prior to paving can disturb the base surface. After trimming, the base may be rough in certain locations, increasing the surface for bonding. A bond-breaking medium as listed in Table 8-2 should be applied in these isolated areas of roughness.

Concrete Paving

Field Verification of the Concrete Mixture

Key Points

- Properties of the concrete must be verified both before and during construction to confirm that it is suitable for the intended use.
- Field verification of mixtures should use the production equipment anticipated for the job.

Proper quality control (QC) for a concrete paving project is conducted in three stages:

- Mixture prequalification design in the laboratory
- Mixture verification in the field
- QC during production

The mixture properties that are required depend, in large part, on the intended use of the concrete. Concrete suitable for slipform paving is different from concrete required for hand-placing flatwork. Similarly, fast-track concrete differs significantly from normal-setting concrete. Regardless of the mixture, its properties must be verified before construction to confirm that it is suitable for the intended use and conforms to the properties observed during the laboratory mixture design stage.

Field verification of mixtures should use the production equipment anticipated for the job and may also include the construction of a test strip, when deemed necessary. Test strips, when used, may be a segment of the planned project. [Table 9-4](#) provides available tests and analysis tools for field verification. A preconstruction

meeting between the contractor, agency, construction manager, and/or testing laboratory is recommended to establish working criteria, goals, and practices for the project. The meeting provides an opportunity for the project team to resolve issues before they occur during construction. It also gives the team an opportunity to establish a system for responding to problems that may occur during construction. The contractor typically furnishes a QC plan for mixture design and field verification during paving.

Concrete Production

Key Points

- Variability of the production process must be minimized to produce concrete of consistent quality and uniformity.
- Material variations must be recognized and accounted for with planned and permitted field adjustments.
- The plant must have the capacity to meet production requirements for the project.
- A QC plan outlining the process for maintaining the production and construction operations under control in order to produce a consistent product with the desired quality may be required.
- Critical aspects of aggregate stockpile management include maintaining uniform grading and moisture content and preventing aggregate contamination.
- Dry ingredients in concrete should be batched by weight.
- The sequence in which materials are introduced into the mixer must be consistent.
- Materials should be introduced into the mixer in a manner that assures that each batch contains the approved mixture design proportions.
- Sufficient mixing time must be allowed to ensure a homogeneous mixture and to entrain the required air-void system.
- Concrete delivery must be consistent and on time.

Concrete production is a manufacturing process. However, concrete is manufactured from raw or commodity materials such as aggregates, fly ash, and cement, which have inherent variability. Because of variability in the constituent materials and in measuring them, concrete mixtures' properties will vary. To produce concrete of consistent quality and uniformity, the variability of the production process must be minimized while recognizing and accounting for material variations.

It is important to consider the mixture design, as well as a realistic production schedule, in the plant selection process. Production capacity and limits on haul time require forethought. Projects in congested areas, which do not allow for on-site production, may require a mix design that allows for extended hauling and placement times.

Setting Up the Plant

Concrete plants are either permanent, stationary facilities, or they may consist of portable equipment that is erected adjacent to the paving site (see Figure 8-6).

Plant location and setup depend primarily on site factors like zoning, access to utilities, availability of materials, and public traffic (urban or rural). The plant must have the capacity necessary to meet the production requirements for the project.

Optimizing traffic flow at the plant is important. Items to consider include the following:

- Plant safety
- Delivery of raw materials
- Delivery of concrete
- QC-related traffic operations and testing personnel safety
- Operation of equipment for managing the aggregate stockpiles
- Environmental impact

The concrete plant needs to be in good condition, operate reliably, and produce acceptable concrete uniformly from batch to batch. Plants should be inspected prior to the start (or restart) of each paving project and when uniformity or strength problems are encountered during production. Table 8-3 provides a checklist for inspection.



Jim Grove, ATI Inc./FHWA, used with permission

Figure 8-6. Portable central-mix concrete plant

Table 8-3. Concrete plant checklist

No.	Inspection item
1	Check foundations of stockpiles for proper separation and adequate drainage.
2	Check bins for adequate partitions to prevent intermingling of aggregates.
3	Check scales with test weights throughout range to be used.
4	Check scales for seals by approved agency.
5	Check water meter for accuracy.
6	Check for leakage of lines.
7	Check capacity of boilers and chillers if their use is anticipated.
8	Check admixture dispensers for accuracy.
9	Check mixers for hardened concrete around blades.
10	Inspect concrete hauling units for cleanliness.
11	Check to ensure that all concrete-making materials have been certified and approved for use.
12	Observe stockpiling operations. Verify that segregation and contamination will not occur.
13	Observe charging of the bins. Verify that segregation and contamination will not occur.
14	Review aggregate moisture tests.
15	Observe batching operations at start and periodically during production.
16	Check scales for zeroing.
17	Check to ensure proper batch weights are set on the scales.

Also see the FHWA's State Highway and Transportation Department Concrete Plant Inspector's Checklist at <https://www.fhwa.dot.gov/construction/reviews/revconc3.cfm>.

Handling Materials

Material-management requirements are similar for either transit mix or central mix operations. The contractor and/or material suppliers should handle all of the materials in such a way as to maintain quality and uniformity. The contractor should use only certified materials on the project and follow the manufacturer's recommendations, as appropriate.

The contractor and the concrete producer should ensure that all materials meet the project specifications. Many projects require a QC plan outlining the process for assuring the quality of the materials and mixture. The agency typically reviews the QC plan and verifies that the contractor/supplier is operating in accordance with the approved plan.

At the plant, different cementitious materials (cement, fly ash, or ground granulated blast furnace [GGBF] slag) must be kept in separate silos or storage units. Systems must be implemented to ensure that the cementitious materials are loaded into the correct silos when they are delivered. Unloading of the cementitious materials takes time. Therefore, it is vital to maintain an adequate area for cement, fly ash, and other supplementary material deliveries.

Stockpile Management

Stockpile management is the coordination of the aggregate delivery, storage, and loading into the mixing plant, which is a vital aspect of consistent, quality concrete production (ACPA 2004). Locating the stockpiles is an important first consideration. A relatively flat area is preferred to facilitate unloading and stockpiling the aggregates. Also, place a pad or aggregate separation layer in the stockpile area. This will minimize contamination of the aggregate from the soil below as well as prevent material loss.

The goal with aggregate stockpiles is to maintain uniform gradation and moisture content and prevent aggregate contamination throughout the project. Consistent aggregate will contribute to consistent concrete. A few basic stockpiling concepts include the following:

- Pile the material in lifts
- Complete each lift before beginning the next
- Do not dump material over the edges of a stockpile
- Minimize free-fall heights of aggregates to avoid segregation

- Only stockpile as much material as practical
- Minimize crushing of the aggregate by the loader
- Manage the stockpile carefully to obtain close to saturated surface dry (SSD) condition. For example, thoroughly wet the aggregate and then let it stand an hour before batching
- Monitor the moisture content of the aggregate in the stockpile and adjust the mixing water required accordingly

In some cases, the aggregates may be contaminated with clay or soil before arriving on the plant site. Dirty aggregates require washing or cleaning or should be rejected. In addition to causing clay ball problems in the concrete, dirty aggregates can lead to problems such as low strength. The loader operator must control the elevation of the loader blade to prevent picking up contamination from below the aggregate stockpile and has a key role in preventing clay or mud from being deposited into the plant's feed hoppers (Figure 8-7).



Jim Grove, ATI Inc./FHWA, used with permission

Figure 8-7. Loader operation is key to stockpile management

Portable central-mix plants are usually more susceptible to producing concrete contaminated with clay balls, simply because they are temporarily placed near the project site and may have clay or loose soil underneath the stockpiles. The batch plant or concrete foreperson must keep a close eye on stockpile management at portable plant sites. Stationary ready-mix plants often have a paved surface or bunkers on which the stockpiles are placed or stored and where the loader operates. This reduces the likelihood of clay being introduced into the ready-mixed concrete.

The aggregate loader operator is an important person in the production of consistent quality concrete. The primary functions of the loader operator include the following:

- Visually noticing changes in aggregate moisture content and notifying the plant operator that adjustments may be necessary
- Working the stockpile to provide uniform water content and gradation, while avoiding segregation and degradation of the materials
- Identifying and minimizing contamination from mud tracked by transport vehicles
- Observing and reporting moisture variation
- Adding material to the feed hopper(s) appropriately
- Notifying the plant foreperson of anticipated aggregate shortages

Batching

Batching is the process of measuring the mixture ingredients and introducing them into the mixer (for information about batching as it affects concrete uniformity, see [Batching Operations under Uniformity of Mixture in Chapter 6](#)).

Dry ingredients in concrete should be batched by weight, while water and chemical admixtures may be batched by volume. The potential for error in volume batching cement and aggregates is large because of bulking of the materials with handling and increasing moisture content.

The order in which materials are introduced into the mixer is important to ensure uniform mixing and maximize concrete consistency. Figure 8-8 shows the typical sequence of adding components into a stationary mix plant.

In some cases, materials are preblended on the conveyor belt as they enter the mixer. One batch of concrete is mixed while another is being batched. These operations occur simultaneously.

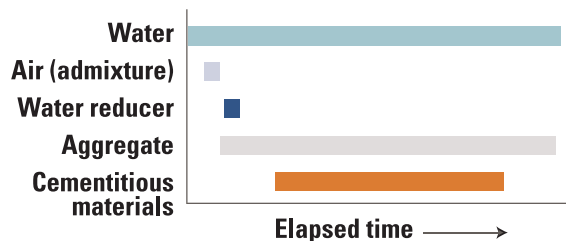

Ayers et al. 2000

Figure 8-8. Typical sequence of adding material in a stationary mix plant

Specific sequences may vary depending on the materials. The plant operator may adjust the sequence to accommodate production requirements or if incompatibility is reported to occur. The requirements for specialty materials, such as fibers and other additives, may also alter the sequence. The sequencing of ingredients will also have an important effect on the uniformity of truck-mixed concrete. Elevating the rear portion of the truck mixer during charging operations minimizes the time required to get all the ingredients into the drum. Figure 8-9 shows the typical sequence of adding components into a truck mixer.

Once agreed upon, the sequencing process should remain the same. A sequencing diagram is a useful tool in clearly showing the particular charging process for the concrete mix and plant.

In a dry-batch process, the first ingredients into the drum are usually a portion of the water and a portion of the coarse aggregate. The water is shut off and aggregates and cementitious materials are combined until all of the cementitious material is in the drum. The final portion of water goes in with the last of the aggregates to clean and wash any cementitious material clinging to the mixer's hoppers, rear fins, and chutes (Ayers et al. 2000).

Ribbon loading is a method of batching concrete in which the solid ingredients, and sometimes the water, enter the mixer simultaneously. This process will often produce a very consistent product if the plant is configured appropriately.

Aggregate moisture content (monitored using probes in the stockpile) and the potential for segregation greatly affect concrete quality and uniformity. If the aggregate moisture content is lower than the SSD moisture, additional water will be required in the mix to prevent stiffening caused by water being absorbed into the aggregate (see [Moisture/Absorption Correction in Chapter 7](#)).

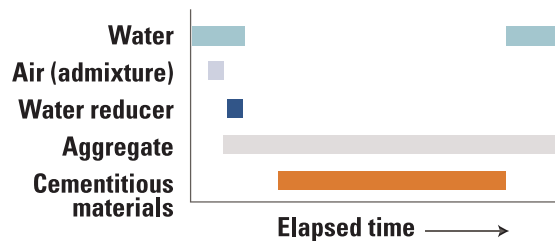

Ayers et al. 2000

Figure 8-9. Typical sequence of adding material in a truck mixer

The maximum additional amount of water required in the mix is calculated as the difference between the SSD moisture and the current moisture content, multiplied by the mass of the respective aggregate. However, if the aggregate is wetter than the SSD value, the amount of water must be reduced at the batch plant. Otherwise, the water/cementitious materials (w/cm) ratio of the mix will be exceeded, leading to low strength and poor durability.

Aggregate moisture content and the potential for segregation greatly affect concrete quality and uniformity. ASTM C94 provides four key items to control uniformity:

- For each size of coarse aggregate, use separate aggregate bins that can shut off material with precision.
- Use controls to monitor aggregate quantities during hopper charging.
- Use scales accurate to ± 0.2 percent tested within each quarter of the total scale capacity. Adequate standard test weights for checking scale accuracy should be available.
- Add water to an accuracy of 1 percent of the required total mixing water.

The following considerations are important for controlling batch-to-batch consistency (ACPA 2004):

- The plant foreperson must ensure a consistent and clean operation of the front-end loaders and other heavy equipment that move raw materials at the batch plant.
- Aggregate stockpiles should be maintained at or above SSD to prevent absorption of water during the batching process. The amount of water required to maintain the stockpiles at or above SSD is dependent upon weather conditions and the absorption properties of the aggregates.
- Periodic moisture tests on the fine and coarse aggregate are necessary (at least twice a day).
- Truck operators must be sure to remove free water or excess release compounds from drums or dump beds after washing or rainfall.

Mixing Concrete

Concrete is normally mixed and delivered using one or a combination of the following operations:

- Central mixing. In a central-mix concrete plant, the plant operator adds the batched (weighed or metered) ingredients into a stationary mixer. The mixer then

completely mixes the components before discharging the concrete into a delivery vehicle for transporting to the point of discharge. The delivery vehicle can be a truck mixer operating at low mixing speed, a truck agitator, or a nonagitating (e.g., dump) truck.

- Shrink mixing. Shrink-mixed concrete is partially mixed in a stationary mixer and then transported while mixing is completed in a truck mixer.
- Truck mixing. Truck-mixed concrete is mixed entirely in the truck mixer.

Changes to the mixture's water and admixtures are possible at the jobsite if a truck mixer is used to transport the mixture (Ayers et al. 2000).

The required mix time varies depending on the equipment, proportions, and materials used; gradations of aggregates; amount and types of admixtures; temperature, etc. However, if there are any problems regarding a concrete mix, such as segregation, bleeding, finishing, etc., the first and easiest aspect to change or consider is the mix time. For a portable central mix batch plant that is used to produce a concrete paving mixture, mix times will typically range from 60 to 90 seconds. Short mixing periods will reduce the amount of entrained air and will likely lead to a nonuniform mixture ([see Type of Plant and Production Procedures in the discussion about Air-Void System under Factors Affecting Resistance to Freezing and Thawing in Chapter 6](#)).

Delivering Concrete

Consistent delivery of concrete to the paving project site is an important element in maintaining a uniform, trouble-free paving operation (ACPA 2003a). This is usually less challenging in rural areas than in urban areas because haul roads are wider and haul trucks may travel freely. However, densely populated urban areas require careful evaluation to determine whether traffic delays will hamper concrete delivery. Consideration of the concrete mixture's stiffening properties is also necessary, with normal-setting mixtures allowing longer travel times than fast-setting mixtures.

Feeding concrete into the paving machine consistently requires an adequate number of batch delivery trucks. The number of trucks will often dictate the slipform or placement speed. The entire cycle of mixing, discharging, traveling, and depositing concrete must be coordinated for the mixing plant capacity, hauling distance, and spreader and paving machine capabilities. Extra trucks may be needed as the haul time increases.

The manner in which the crew deposits concrete in front of the paving operation is an important factor in this cycle and in creating a smooth pavement surface. For slipform paving (see the section later in this chapter on Paving), the amount of concrete being carried in front of the paving machine (the head) must be controlled to ensure that it does not get too high or too low (Figure 8-10).

If the head gets too high, it creates a pressure increase under the paving machine. The surge can cause the concrete behind the machine's finish pan to swell, creating an uncorrectable surface bump. The slipform machine may even lose traction and steering. If there is not enough material in front of the paving machine, then the concrete head may run out or the grout box may run empty, creating a low spot and voids or pockets in the pavement surface. Avoid such problems by using a placer/spreader machine (Figure 8-11) or by carefully depositing concrete from the haul trucks.



ACPA, used with permission

Figure 8-10. Depositing concrete in front of the paving machine



ACPA, used with permission

Figure 8-11. A belt placer/spreader ensures a consistent amount of concrete in front of the paver

Field Adjustments

As discussed previously, the materials used to make concrete are inherently variable, as are the conditions in which they are mixed and placed. It is therefore important that the properties of the fresh concrete are closely monitored and proportions adjusted (within the constraints of the specification) to improve the uniformity of the final product from batch to batch and day to day. The following sections discuss some of the variables that need to be considered as paving proceeds.

Ambient Temperatures

Daily and seasonal temperature variations impact the fresh and hardened concrete. Concrete stiffens, sets, and gains strength faster as the temperature rises. Hot weather is therefore a source of problems for the paving process.

Sprinkling aggregate stockpiles and chilling the mix water or using ice are normally the first responses to hot weather; however, the total amount of water and ice in the mixture must not exceed the mixing water in the mix design.

Tips for Managing a Head of Concrete

The material in the grout box should be continuously refreshed. Material that is allowed to remain in the grout box for an extended time may result in pockets of aggregate with a lower specific gravity (i.e., lighter and less durable), potentially leading to scaling, honeycombing, and cracking. Therefore, managing the concrete head is a matter of both the amount of material in the grout box and continuous flow of material through the grout box.

The head level should completely cover the vibrators, and the vibrators should be slightly angled downward. Do not allow the head to run out. When the head is gone, there may not be enough concrete to completely build the slab. Paving operations must then be stopped and concrete brought to the paver to fill the required head. This is disruptive and costly.

ASTM C94/AASHTO M 157 allow water to be added to remix the concrete when the transit mix truck arrives on the jobsite and the slump is less than specified, providing the following conditions are met:

- Maximum allowable water/cement ratio is not exceeded
- Maximum allowable slump is not exceeded
- Maximum allowable mixing and agitating time (or drum revolutions) are not exceeded
- Concrete is remixed for a minimum of 30 revolutions at mixing speed or until the uniformity of the concrete is within the limits described in ASTM C94/AASHTO M 157

Water should not be added to a partial load.

Adjustments for cool or falling temperatures are less critical with respect to the w/cm ratio and strength. However, consistent workability must still be maintained. Heated water is a common mix adjustment when cooler temperatures occur. Consistent cool temperatures may also require the addition of an accelerating admixture to minimize the risk of random cracking due to delayed sawing operations.

Materials Variability

Three of the four largest constituents in a concrete mix by volume—coarse aggregate, fine aggregate, and cementitious materials—are processed/manufactured from raw materials that are extracted from naturally occurring deposits. The very nature of these materials dictates that they have an inherent variability. The quarrying and manufacturing processes used to produce concrete materials reduce but do not eliminate all of this variability.

Moisture content in the aggregate stockpiles is the most common parameter that requires an adjustment in the plant process. Stockpiles should be sampled and tested at least daily, or, depending on weather conditions, more frequent testing may be required. The plant should be capable of compensating for free water from the aggregates. Most modern batch plants have moisture sensors in their fine aggregate bins.

Aggregate grading should be monitored at least daily. Frequent density (unit weight) tests can be helpful in detecting changes in aggregate gradation. Modest variations in gradation are normal and will not generally have an adverse impact on performance. Severely segregated stockpiles should be rejected or rebuilt. Batch proportions of the aggregates should be adjusted if the combined gradation of the mix deviates significantly from the mix design and the workability properties are causing placement difficulties.

Variability in cementitious materials also impacts workability. There are currently no standard test methods that provide timely feedback on this variable; therefore, adjustments must be made based on feedback from the paver. Changes in cement and SCM fineness (higher Blaine value) may require additional water and air-entraining admixture (AEA) to maintain workability and air content.

Material Supply Changes

When an ingredient source is replaced or the amount required changes by more than 5 percent (excluding admixtures used within recommended dosages), trial batches are needed. Time is usually a critical factor in how material changes are handled. The best and safest alternative is to batch anticipated mix designs in the laboratory well before construction starts. Otherwise, workability, setting time, air entrainment properties, and early-age strength (maturity and/or three-day strength) should be closely compared with the initial mix design; proceed with caution and increase testing frequency during the initial days with the new materials.

Paving

Key Points

- Slipform or fixed-form paving methods can be used.
- Concrete mixtures and practices vary according to placement method.
- Slipform paving generally results in improved consolidation and a smoother surface as compared to fixed-form placement. Therefore, it is used whenever practical.
- Fixed-form paving is adaptable to nearly any placement circumstance.
- The paving train is a term referring to the combination of individual machines that place and finish concrete pavement.
- All equipment must be suitable for the application, well maintained, and operated by suitably trained personnel.

Contractors use either slipform or fixed-form paving methods, depending upon the nature of the placement. The concrete mixtures required by either placement method vary significantly. Slipform paving operations require a low-slump mixture that will not slough after extrusion by the paving machine; whereas, a fixed-form paving operation relies on a more workable mixture that will flow easily to fill the forms.

The paving train is a term referring to the combination of individual machines that place and finish concrete pavement. For highway applications, a paving train may include the following:

- Spreader with belt placer
- Slipform paver
- Texturing machine
- Curing cart (usually together with the texturing unit)

Equipment Setup

The following critical elements should be in place before production paving starts (IPRF 2003):

- Check all the equipment in the paving train to make sure it is in operational condition.
- Check that approved test reports are available for all materials in storage at the jobsite and the plant site.
- Verify that backup testing equipment is available; develop extra equipment backup plans.
- Verify that all necessary concrete placement tools are available, such as hand tools, straightedges, hand floats, edgers, and hand vibrators.
- Verify that radio/telephone communication with the plant is operational.
- Verify that equipment is available to water the grade, if necessary.
- Monitor the string line or stringless control system regularly and re-tension string line as necessary (slipform only).
- Check the forms for proper bracing (fixed form only).
- Verify that materials and tools for the day's work header are on hand, or just saw off the excess.
- Develop an extreme-weather management plan.
- Check the weather forecast for each day of paving, and save weather data (temperatures, wind speed, humidity, and precipitation) for future reference.
- Make sure a sufficient length of plastic covering is available in case of sudden and unexpected rain.

Placement (Fixed Form)

There are a variety of fixed-form paving machines; the less complex equipment includes hand-operated and self-propelled vibratory screeds, single-tube finishers (Figure 8-12), and revolving triple tubes.



ACPA, used with permission

Figure 8-12. A roller screed (single-tube finisher) can be used to strike off the concrete in fixed-form placements

Vibratory screeds and larger, form-riding machines (e.g., bridge deck finishers) can place and consolidate the concrete between forms in one pass. These machines ride on the forms or on rails laid outside the forms. While most commonly used for concrete floor construction, laser screeds are emerging as an alternative finishing tool in some parking lot and municipal paving applications. This self-propelled screed consists of a plow, auger, and vibrator that employs an automatic laser control to assure proper pavement elevation.

To make paving easier, it is important to evenly deposit concrete onto the grade in front of the fixed-form placement machine. Piling too much concrete in front of the machine leads to difficulty with striking off. The concrete should not overly exceed the height of the forms. However, piling too little concrete in front of the machine may produce low spots in the pavement surface. Although it is ideal to distribute the concrete evenly with the chute from the ready-mix or other concrete-hauling truck, some distribution of the concrete with hand tools is usually necessary. Concrete should never be moved with a vibrator, which is for consolidation only.

Using vibrators to move concrete can segregate the mix, sending the large aggregate to the bottom and paste to the top. This can also compromise the air entrainment and ultimately the concrete durability.

For ease of removal and cleaning forms, a thin application of oil before paving is recommended. Without oil, concrete can adhere to the steel or wooden surfaces of the forms. The paving crew should inspect forms just before paving and carefully reapply oil to any dry areas. If steel reinforcement is in place, care is necessary to avoid getting oil onto the bars.

Consolidation (Fixed Form)

A combination of internal and surface vibration is preferable for reinforced slabs at any thickness (Kosmatka and Wilson 2016). Because surface vibration of concrete slabs is least effective near the fixed forms, it is also beneficial to consolidate concrete along the forms with a spud vibrator.

Supplemental vibration with handheld spud vibrators should precede the placement screed. Standard practice for thicker slabs calls for vertical plunges of the vibrator head. Operators should neither drag spud vibrators through the concrete nor attempt to move the concrete laterally because either will tend to cause segregation. Leaving the vibrator head inserted for about 5 to 15 seconds will usually provide adequate consolidation. In general, proper consolidation of air-entrained concrete takes less time than non-air-entrained concrete, even when both mixtures are prepared with the same consistency (slump).

Placement (Slipform)

Slipform paving machines operate by extruding the concrete into the shape of the slab. As shown in Figure 8-13, the paver includes the spreader auger (or spreader plow), strike-off, vibrators, tamper bar (optional), profile pan (paving form/mold), or any combination of these items.

The molding components are the bottom of the profile pan or forming plate and the side forms. All of these elements confine the concrete and form its ultimate shape.

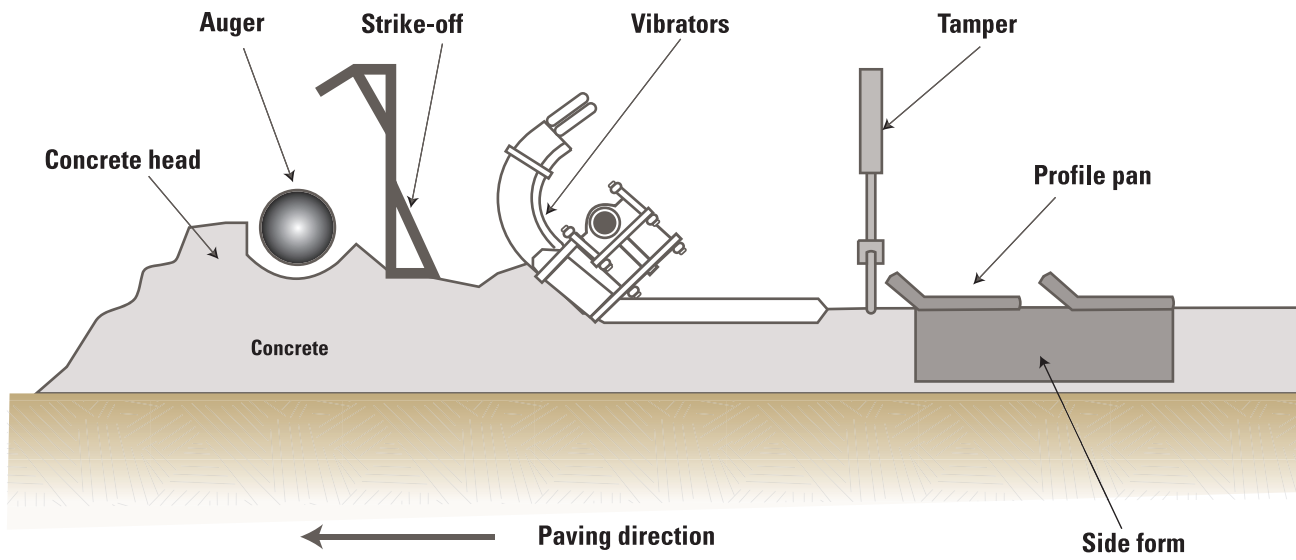

ACPA, used with permission

Figure 8-13. Components of a typical slipform paving machine

In paving, the mold is propelled forward over a volume of concrete that remains static on the grade. Vibrators mounted to the slipform machine fluidize the concrete and make it easier to consolidate and slip through the mold. The slipform paver thus passes over the fluidized concrete while its mass keeps the pan and side forms steady to confine and shape the concrete. The following factors influence the required extrusion pressure:

- Angle of the profile pan relative to the desired pavement surface plane, which should be as flat as possible
- Vibrator power and frequency
- Paver speed
- Concrete workability

The primary adjustments made to a slipform paving machine are the following:

- Paving speed
- Vibrator frequencies
- Vibrator height
- Elevation control sensitivity adjusted to tune the paver and then left static
- Angle of the profile pan adjusted to be parallel to the pavement surface through vertical curves and as flat as practical in tangent sections
- Concrete head in the grout box

If the concrete's plastic properties vary widely, requiring frequent adjustments of the placing speed or vibration frequency, the result will be a nonuniform surface.

A slipform paving machine must spread and consolidate the concrete as it moves forward, and it cannot produce a smooth riding surface if it must stop often or push a large pile of concrete ahead of it.

Consolidation (Slipform)

Vibration is necessary for consolidating the concrete. On slipform pavers, a series of vibrators fluidize the concrete and remove large air voids (Figure 8-14).

The vibrators are typically set at a constant frequency, which can be monitored and adjusted by the paver operator. Some adjustment to vibrator frequency may be helpful, but running the vibrator at a higher frequency should not be used to overcome poor equipment setup, poor alignment, or poor mixtures ([see Vibration Monitoring in Chapter 9](#)).



Figure 8-14. An array of vibrators under a slipform paver

Vibrators may cause undesirable effects, such as loss of air entrainment or vibrator trails, when operating at a very high frequency. For most mixtures, a frequency from 5,000 to 8,000 vibrations per minute can adequately fluidize and consolidate the concrete without loss of entrained air or segregation of particles (Tymkowicz and Steffes 1999). Vibrator frequency should be adjusted for the paving speed. Typical paving speeds range from 3 to 15 fpm.

Vibrator sensing systems are available to provide a real-time readout of vibration frequency for all of the vibrators on a slipform paving machine. These units permit alarm settings that alert the operator of high or low frequencies for all or individual vibrators or total loss of vibration. Mixtures that are gap graded (over sanded) will tend to segregate more easily than well-graded mixtures at a given vibration frequency. Therefore, the need for reduced vibration frequencies is critical for gap-graded mixtures.

If the operator slows the paver to match the delivery of concrete, reduction of the vibration frequency is also likely to be necessary to maintain consistent extrusion pressure. The adjustment is relative to the normal vibration frequency and paving speed of the operation.

Horizontal and Vertical Control of the Paver

The profile pan, the part of a slipform paver that controls the pavement surface, references its position from sensors that follow string lines placed along the grade, usually on both sides of the paver. Or, the reference is set by a three-dimensional (3D) machine control system that projects virtual string lines and interfaces with the paver's electrical and hydraulic systems.

String Lines

The string line has been the primary guidance system for a slipform paver (ACPA 2003a), but the industry is rapidly migrating to 3D machine control (stringless) systems. The paver's elevation sensing wand rides beneath the string, and the alignment sensing wand rides against the inside of the string. Neither of these wands should deflect the line any measurable amount. A typical setup includes a string line on each side of the machine (Figure 8-15). The string line itself may be wire, cable, woven nylon, polyethylene rope, or another similar material.

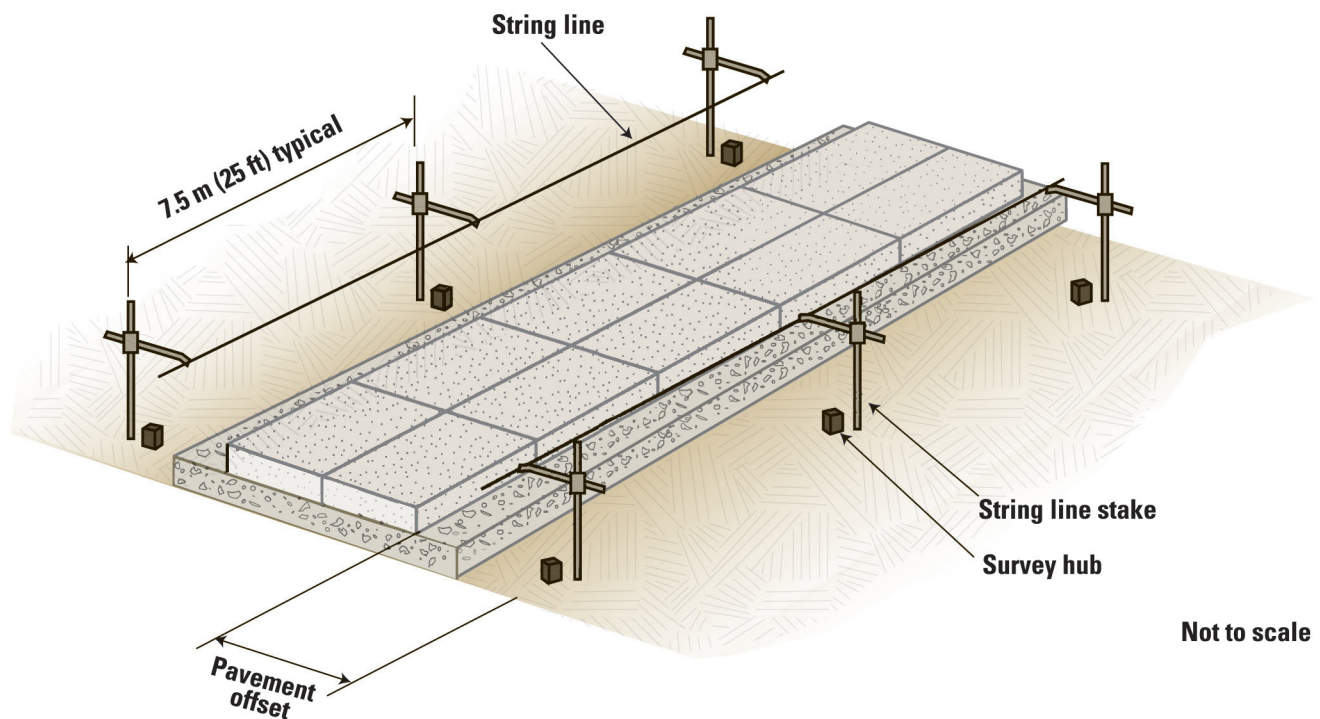

ACPA 2003b, used with permission

Figure 8-15. Typical string line setup

The string lines are not necessarily parallel to the grade, but they are set to form the surface regardless of the grade elevation. A well-positioned string line can help overcome minor surface deviations in a base or trackline, but it is not a substitute for a smooth, stable trackline built to a tight tolerance. The electronic/hydraulic systems that control a slipform paving machine's elevation cannot adjust quickly enough to compensate for significant variations in the machine's vertical position caused by an unstable base or trackline. An unstable trackline causes the elevation control system of a paver to continually adjust in an attempt to keep the profile pan in a position relative to the desired pavement surface. These types of adjustments cause bumps or dips in the resulting pavement surface if they are too abrupt or too frequent (ACPA 2003a).

Achieving a smooth surface with slipform paving requires close attention to the setup and maintenance of the string line. The string line material, stakes, staking interval, splices, and repositioning frequency all may impact the resulting pavement surface. Stakes that secure the string line should be long enough to be firm when driven into the subgrade. There must be an adequate stake length exposed above the grade to allow adjustment of the string line to the desired height above the subgrade survey hub, typically 6 in. to 1.5 ft. A maximum spacing between stakes of no more than 25 ft on tangent sections will produce the best results. Decreasing this interval in horizontal and vertical curves is recommended.

Reducing how often a string line must be set up during the project can lead to better smoothness control. Where possible, it is advantageous to set up one string line on each side of the paving area to serve all operations, including subgrade preparation, subgrade stabilization, base construction, and pavement placement. For multi-operational usage, the stakes and strings must be offset farther from the pavement area to keep them clear of the equipment and operations.

In many instances, the haul road is next to the string line. This arrangement necessitates regular inspection of the string line by eye to determine whether any heaving or settling of the grade disturbed the hubs and/or line stakes. It takes considerable experience to properly "eyeball" corrections to a string line due to a deviation in the grade. When a deviation is noticed, the survey or string line crew should reposition misaligned stakes immediately. It is sometimes advantageous to check a string line at night using light shone from vehicle headlights. This night smoothing technique reduces visibility of background objects and enhances the ability to focus solely on the illuminated string line.

One alternative to using string lines is the use of a ski, which senses off of a previously paved surface and averages the profile of the existing surface over the length of the ski. "Locking to grade" is the terminology used to describe paving without any vertical control (no string lines or ski). The use of these alternatives is dictated by their need in special situations and the demonstration of similar tolerances and accuracies to string line guided pavers.

3D Machine Control

Stringless paving (3D machine control or automated machine guidance) replaces the physical string line with a virtual profile (Figure 8-16).

These systems allow the paver to place a pavement to a true profile as opposed to string lines, which consist of a series of cords. The 3D model used for stringless paving will represent the pavement edges and break points as a series of tangents and smooth arcs (Reeder and Nelson 2015).

The use of 3D machine control systems requires additional setup activities, as follows:

- Verify control points' location and accuracy
- Verify unobstructed view of instruments to paver
- Confirm that instruments are out of traffic
- Map out distance to and from instruments to paver for leap frogging
- Verify that correct pavement design file is loaded and ready for use
- Verify that radio communication is working
- Be sure that batteries required for instruments are charged and working

A summary of the advantages of stringless systems includes the following:

- Narrower work space requirements for the paving operation
- Mathematical processes for optimizing the profiles and computer-simulated models to visually identify potential errors in the model
- Elimination of sources of roughness from string line such as sag, pumping of the string line pins due to pad-line instability, bumping of the string line by equipment and/or workers, etc.

Further information on stringless paving is available at <http://publications.iowa.gov/20318/>.

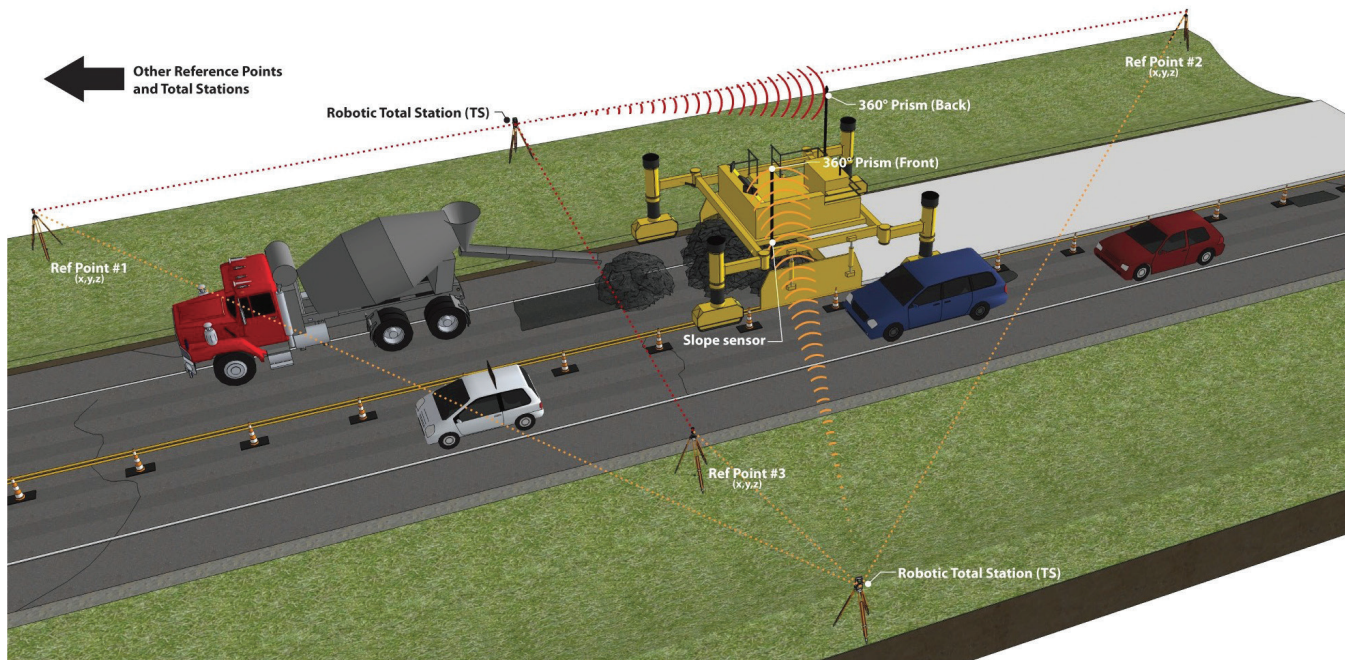

Snyder & Associates, Inc., *CP Road Map* October 2010

Figure 8-16. Conceptual illustration of stringless paving

Edge Slump

Edge slump occurs when the top edge of a freshly placed, slipformed concrete pavement sags down after the slab is extruded from behind the paver (Figure 8-17).

Slipform paving molds have an adjustment to compensate for edge slump (Figure 8-18).

When the slab edge forms the absolute extent (free edge) of the pavement, some amount of edge slump is acceptable. Any edge slump on the high side of a longitudinal joint that has the potential to pond water should be corrected.

Edge slump is generally more common in thicker pavements, which have to stand higher and are therefore more susceptible. The most common form of edge slump is when the top edge slumps down. The bottom edge slumping out usually indicates a more serious problem with the mix design and is often associated with higher slump mixtures that are not intended for slipform paving. When this type of edge slump occurs, paving should be suspended until the concrete mixture has been modified to work with slipform paving.

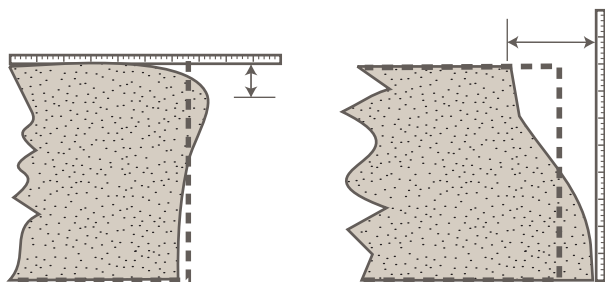

Top edge slumps down
 Place straightedge on surface. Measure vertical distance between edge of slab at its greatest point of slump and straightedge.

Bottom edge slumps out
 Place straightedge along slab edge at greatest point of slump. Measure horizontal distance between top edge of slab and straightedge.

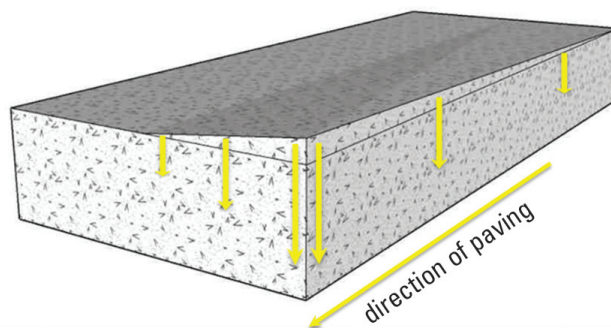

Figure 8-17. Two types of edge slump

Figure 8-18. Adjustment of the paving mold allows for edge slump

The following factors affect edge slump:

- Concrete consistency
- Concrete mixture compatibility with placement techniques
- Paver adjustments and operation
- Excessive finishing
- Segregation on the belt placer or from over-manipulation from the auger/plow

Most specifications limit the area considering edge slump to within 6 to 12 in. away from the slab edge. In general, most agencies specify an edge slump of ¼ in. as the trigger for corrective action.

Corrective action usually involves the finishers behind the paver reworking the edge to remove the irregularity. However, continual correction of excessive edge slump in fresh concrete can lead to unacceptable levels of joint spalling in the finished concrete. If such a problem develops, paving should be stopped and measures taken to correct excessive edge slump.

In most cases, edge slump can be corrected immediately behind the paver, and the mixture can be calibrated to prevent reoccurrence.

If the edge slump results in ponding of water and is not detected in time, it may require patching and/or diamond grinding to correct the irregularity.

Dowel Bars and Tiebars

Key Points

- Dowel bars are used to provide support between adjacent panels in a pavement.
- Tiebars hold adjacent lanes together and thus facilitate load transfer at longitudinal joints.
- Dowel assemblies must be placed in the required locations and fixed to prevent movement when concrete is placed over them.
- Using specialized equipment, dowels can be inserted after concrete placement.
- Shipping wires on dowel basket assemblies should be left intact to enhance stability during the paving operation.

Dowel bars are used to provide support between adjacent panels in a pavement. Tiebars hold adjacent lanes together and thus facilitate load transfer at longitudinal joints.

They are either placed in baskets (dowels) or chairs (tiebars) or inserted into the fresh concrete (see [Dowel Bars, Tiebars, and Reinforcement in Chapter 4](#) and [Dowel Bar Tolerances in Chapter 9](#)).

Pre-Placed Bars

Dowel assemblies are fastened to the subbase using steel staking pins for granular materials or nailing clips for stabilized materials (Figure 8-19).



ACPA 2010, used with permission

Figure 8-19. Staking or pinning dowel bar cages

If not properly fastened, the bars may tip or move under the pressure of paving. It is therefore important that the cages be pinned securely so that they do not move when the paver passes over them. A minimum of eight pins/clips is recommended to anchor the baskets, with the pins located on the upstream side of the basket. Base type and thickness can influence the number of pins/clips necessary to assure that dowels are not displaced during the paving process.

Mini-baskets (e.g., short baskets used for small groups of dowels, often concentrated in wheel paths) should be installed with a minimum of four anchors. Mini-basket anchor locations can also be placed on one or both sides of the basket, as described above for full lane-width baskets.

Care in positioning the baskets is also necessary so that joints can be sawed directly over the basket and perpendicular to the centerline.



Jim Grove, ATI Inc./FHWA, used with permission

Figure 8-20. Dowel basket marked with paint for the saw crew (left) and an inserted dowel marked with a nail and washer (right)

The location of the baskets must be marked so that saw cuts can be accurately placed; this is commonly done with a paint mark on the paver trackline, which is then transferred to the fresh slab after curing. These marks must be durable and on both sides of the slab so that the joint is cut as nearly as possible to the center of the dowel bars. Alternatively, a nail and washer may be used to mark dowel locations for the saw crew (Figure 8-20).

Dowel baskets and tiebars may disrupt the consolidation pressure during the passage of a slipform paver. This can result in a bump and/or dip in the surface of the pavement or an indentation in the edge of the slab in the area of the basket. Some contractors find that placing concrete over dowel assemblies before passage of the paving machine eliminates dowel assembly pressure effects. Others find the use of properly adjusted tools such as oscillating beams, auto floats, and drag pans may help remove spring-back and rippling effects (ACPA 2010).

In some cases, for longitudinal joints, contractors elect to place tiebars into position ahead of paving. Straight deformed bars on supporting chairs fasten to the subbase or subgrade in a manner similar to dowel baskets. In fixed-form construction, standard tiebars or two-piece bars with a threaded coupling are inserted through holes in the side forms for longitudinal construction joints. Care in consolidating the concrete around these bars is necessary.

The American Concrete Paving Association (ACPA) recommends that dowel basket spacer/tie wires should not be cut after basket placement and prior to paving. The wires serve to brace and stiffen the baskets during paving and help to prevent basket movement as the paver passes. Proponents of cutting the wires cite concern that the tie wires will restrain joint movement,

but this has not been shown to be a problem. Simple analyses of pavement contraction forces indicate that tie wires sized and spaced as recommended previously will either yield or fail at the welds to the basket and will not significantly restrain pavement joint movements (ACPA 2005). It has also been reported that the MIT-DOWEL-SCAN magnetic tomography device for measuring dowel alignment provided more accurate readings when the basket wires were cut. Dowel bar locations should be manually verified periodically behind the paver regardless of whether nondestructive testing will be performed at a later time (Khazanovich et al. 2009).

Inserted Bars

The alternative to placing dowel bars in basket assemblies and tiebars on chairs is to use automatic insertion equipment (Figure 8-21).

The key to controlling the location and positioning of automatically inserted bars is the concrete mixture. Mixtures with well-graded aggregate and appropriate workability produce excellent results with dowel and tiebar insertion. Mixtures with gap-graded aggregate, on the other hand, tend to allow the dowels to migrate within the concrete mass and/or leave surface depression above the dowels; and they may result in edge slumping at tiebar insertion locations.

Regardless of the method of placement, the location of dowel and tiebars should be manually verified periodically throughout each day of paving to assure the following:

- Tiebars are an adequate distance from planned transverse joints to prevent restraint of the joint opening
- Dowels are placed within acceptable tolerances



Jim Grove, ATI Inc./FHWA, used with permission

Figure 8-21. Left, middle, and right: Side-bar inserter, center-bar inserter, and dowel-bar inserter

Dowel and tiebar locations can also be verified using nondestructive testing methods when the concrete has reached adequate strength to walk on. The MIT-DOWEL-SCAN device provides 3D feedback on the location of dowels. Tiebars can be located using the MIT-SCAN-T3, ground penetrating radar, or cover meters.

Finishing

Key Points

- It is best to limit the amount of hand and mechanical finishing.
- Hand finishing of the pavement surface using bull floats is necessary only where the surface left from the paving equipment contains voids or imperfections.

Mechanical longitudinal floats are often overused behind the screed or slipform equipment. In general, it is best to limit hand and mechanical finishing as well as the addition of water to the surface of the pavement during the finishing operations. If longitudinal floating is the only method to produce an acceptably closed surface, adjustments are needed in the concrete mixture and/or to the paving equipment. The agency and contractor should review and adjust their design and operations to improve the results achieved by the paving machine alone.

Checking the surface behind the paving equipment with a 10 to 20 ft hand-operated straightedge is a recommended procedure. Successive straightedge checks should overlap by one-half the length of the

straightedge to help ensure that the tool detects high and low spots in the surface. Experienced finishers can use the straightedge to remove noticeable bumps by employing a scraping motion. Otherwise, they use a long-handled float to smooth bumps and disturbed places in the surface.

Headers (transverse construction joints) are one of the most consistent contributors to the roughness of concrete pavement. This is because headers occur at the end of a day of work or at an interruption for a bridge, intersection, or leave-out. The paving machine must stop at these locations, and the most common practice is to place a wooden form to create the joint. The forming of a header in this manner increases the chance of a bump in the surface due to the hand work necessary to blend the mechanized paving surface with the hand-placed area.

Hand-forming headers can be avoided by using a cutback method to create the joint. The paver operator continues paving until all of the concrete is used. The following morning, a transverse saw cut is made about 5 ft from the end of the hardened concrete slab. The end material is removed and dowels are grouted into holes drilled into the smooth saw face. This method of header construction is less labor intensive and produces a smoother-riding construction joint than is generally achieved using the form and hand-finishing technique. Regardless of the method used for constructing an end-of-day header, an adequate head of concrete must be carried beyond the header location. Failing to do so can result in a dip and can also allow the grout box to empty, which results in durability issues due to the higher paste content of the material deposited as the grout box empties.

Texturing

The texture of a concrete surface affects skid resistance (micro-texture) and noise (macro-texture). Texture is usually applied to the pavement surface while it is plastic, and it is important to apply texture uniformly.

Concrete pavement surfaces are generally textured to provide adequate friction and skid resistance. The texture also affects tire-pavement noise. It is generally preferable to conduct texturing sooner rather than later, so that curing can be applied early. Extensive guidance on selecting a texture and how to build it is provided by Rasmussen (2012).

Drag Textures

Dragging artificial turf or moistened, coarse burlap across the surface of plastic concrete creates a shallow surface texture.

Longitudinal Tining

Longitudinally tined textures are the least likely to be noisy, and they are created by moving a tining device (commonly a metal rake controlled by hand or attached to a mechanical device) across the plastic concrete surface parallel to the centerline.

Transverse Tining

Transversely tined textures are created by moving a tining device across the width of the plastic pavement surface. The tines can be uniformly or randomly spaced or skewed at an angle.

If transverse tining is used, it is recommended that a minimum spacing of 0.5 in. be used.

Diamond Grinding

Diamond grinding is a process of removing a thin layer of hardened concrete pavement using closely spaced diamond saw blades. The next-generation concrete surface (NGCS) uses a grinding head with closely spaced blades and a diamond-grooved texture (Figure 8-22).

Innovative Techniques

Exposed aggregate pavements and pervious pavements are being investigated for their friction and noise levels.

Texture Variability

Whatever technique is used, it is important to apply the texture as uniformly as possible to produce acceptable friction and noise levels. Comprehensive research has shown that skid resistance is independent from the method of texturing (Figure 8-23).

Noise levels have also been shown to be influenced by the type of texture (Figure 8-24).



IGGA 2015

Figure 8-22. Next-generation concrete surface (NGCS)

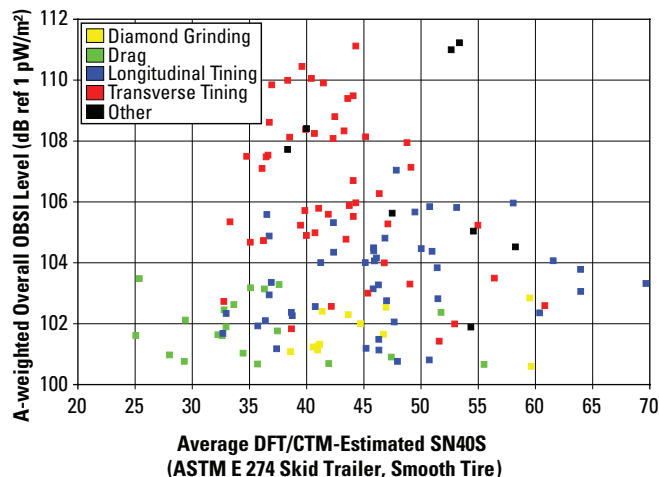

Figure 8-23. Noise and skid resistance are independent

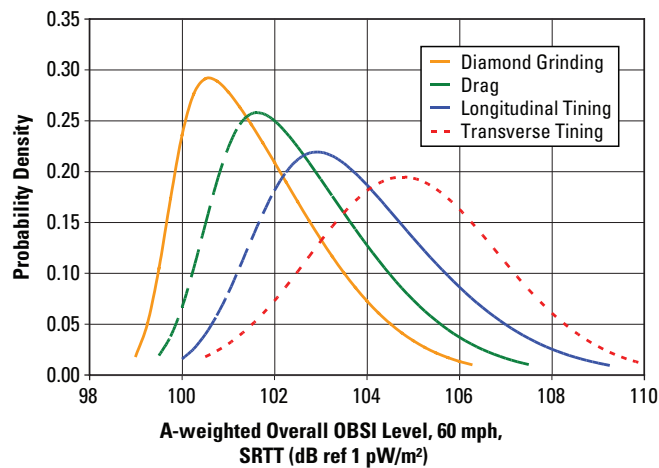

Figure 8-24. Distribution of noise levels from various texturing methods

Although the distribution of noise levels is fairly large, in general, diamond-ground pavements are the quietest, followed by drag textures, longitudinal tined, and transverse tined. Table 8-4 summarizes best practices for constructing quieter pavements.

Pavement Smoothness

Pavement smoothness is the users' primary measure of a pavement's condition, and it is therefore a very

important aspect in terms of quality. Agencies are now starting to use smoothness as a primary indicator of pavement condition and are basing incentive and maintenance decisions on it.

Several specification and construction factors influence the smoothness of a pavement. Tables 8-5 and 8-6 describe these factors (ACPA 2003a, Fick et al. 2018).

Table 8-4. Various concrete pavement texture options

Texture for fresh concrete	Description
Burlap drag	Produced by dragging moistened coarse burlap from a device that allows control of the time and rate of texturing—usually a construction bridge that spans the pavement. Produces 1/16 to 1/8 in. deep striations.
Artificial turf drag	Produced by dragging an inverted section of artificial turf from a device that allows control of the time and rate of texturing—usually a construction bridge that spans the pavement. Produces 1/16 to 1/8 in. deep striations when using turf with 7,200 blades/ft ² .
Transverse broom	Obtained using either a hand broom or mechanical broom device that lightly drags the stiff bristles across the surface. Produces 1/16 to 1/8 in. deep striations.
Longitudinal broom	Achieved in similar manner as transverse broom, except that broom is pulled in a line parallel to the pavement centerline.
Random transverse tining* (perpendicular or skewed)	Achieved by a mechanical device equipped with a tining head (metal rake) that moves across the width of the paving surface laterally or on a skew. (A hand tool is sufficient on smaller areas.)
Longitudinal tining*	Achieved in similar manner as transverse tining, except the tines are pulled in a line parallel to the pavement centerline.
Exposed aggregate	Occasional European practice of applying a set retarder to the new concrete pavement, covering with plastic sheeting, and then washing or brushing away mortar at a later age to expose durable aggregates. Other techniques involve the uniform application of aggregates to the fresh concrete and mechanically abrading the mortar at a later age.
Diamond grinding	Longitudinal, corduroy-like texture made by equipment using diamond saw blades gang-mounted on a cutting head. The cutting head produces 50 to 60 grooves/ft and can remove 1/8 to 3/4 in. from the pavement surface.

* For best results, most agencies precede with a burlap or artificial drag texture.

Adapted from *How to Reduce Tire-Pavement Noise: Better Practices for Constructing and Texturing Concrete Pavement Surfaces* tech brief, National CP Tech Center (Rasmussen et al. 2012)

Table 8-5. Specification factors that influence pavement smoothness

Design/Specification factor	Comment
Base/subbase and trackline	Needs to be stable and built to a tolerance; additional subbase width should be in pay item.
Horizontal alignment, cross-slope, and super-elevated curves	Curves and cross-slopes can add to roughness by design.
Grade and staking calculations	Accuracy of surveying and staking is essential.
Embedded reinforcement and fixtures	Manholes, valve access covers, rebar, etc., have potential to affect smoothness.
Concrete mixture	Proper proportioning and gradation is key to having a mix that will slipform easily.
Access to businesses and local residences	Block-outs or leave-outs will add to roughness; minimize or eliminate if at all possible.

Table 8-6. Construction factors that influence pavement smoothness

Construction factor	Comment
Preparing the grade	Pay attention to the smoothness of each layer of material under the pavement.
Producing consistent concrete	Batch-to-batch consistency is key to producing a smooth pavement.
Delivering concrete	Keeping the paver moving is essential to minimize bumps; hauling is often the critical step in consistent paving.
Setting up fixed forms	Top of form determines surface of the pavement.
Setting and maintaining the string line	Check often; use night-smoothing techniques; ensure that it is taut.
Operating the paving machine	Keep proper amount of concrete (head) consistently in front of paver; minimize stops; monitor vibrators.
Paving on vertical grades and curves	Adjust the paver's profile pan; adjust staking interval.
Handling dowel bars and reinforcement	Place concrete on dowel assemblies before paver; turn down vibrators.
Finishing the surface and headers	Check surface (cut bumps) behind paver with longest straightedge possible; use cut-back header if formed headers cause bumps.
Educating and motivating the crew	Training is essential; explain factors involved and consequences of actions; implement an employee bonus system for smoothness incentives.

The initial smoothness of a concrete pavement is affected by geometric design, concrete mixture, equipment, and human factors. There is always some compromise between achieving the desired smoothness and the volume of concrete required (grade yield) to achieve that smoothness. Agency specifications should be realistic regarding what level of smoothness is attainable based on design factors, especially given the vertical curves, super-elevation transitions, and phasing that limits the length of continuous paving. Contractors should strive to improve the initial smoothness by providing a uniform mixture, tuning the paver to that mixture and project constraints, using hand-finishing techniques to remove short wavelength roughness, providing a uniform texture, and curing the pavement thoroughly.

In addition, the effects of moisture warping and temperature curling have been shown to have a considerable impact on pavement smoothness. In some cases, International Roughness Index (IRI) measurements can vary by as much as 30 in./mi during the span of a day due to temperature curling.

Tools to Evaluate and Improve Initial Smoothness

Lightweight inertial profilers (Figure 8-25) have all but replaced the use of California-style profilographs.

This equipment allows the contractor to get an accurate profile measurement within 24 to 48 hours of paving. For best results on concrete pavements, these profilers should be equipped with line lasers instead of single-point lasers. Initial smoothness readings should be taken as soon as possible after each day of paving as a QC check.



The Transtec Group, Inc., used with permission

Figure 8-25. Lightweight inertial profiler

Real-time smoothness devices mounted to the back of the paver (Figure 8-26) can provide a measure of pavement smoothness as the paving is taking place.



The Transtec Group, Inc., used with permission

Figure 8-26. Real-time smoothness device mounted to the back of a paver

These devices are not a replacement for conventional profiling. They are simply a QC tool that gives real-time feedback regarding the smoothness of the plastic concrete directly behind the paver. The profiles generated by real-time devices do not match what is provided by an inertial profiler, but they do parallel each other. In other words, if the real-time measurement improves, the hardened acceptance measurement will improve also.

ProVAL is a free software tool developed by the Federal Highway Administration (FHWA). It allows the user to analyze profile data (real-time or hardened). The primary uses of ProVAL are the following:

- Smoothness statistics—IRI, PI, and localized roughness
- Power spectral density (PSD) analysis—Identifies sources of roughness that are attributable to repeating wavelengths (e.g., dowel basket rebound, dowel insertion, load spacing, string line sag)
- Grinding simulation—Allows the user to simulate bump grinding to meet localized roughness specification requirements

Curing

Key Points

- Curing is the action taken to maintain adequate moisture and temperature conditions in a young concrete to allow hydration and pozzolanic reactions to proceed.
- Curing primarily affects the quality of the surface of a pavement—the zone that is impacted most by the environment and loading conditions.
- Curing compounds provide the most efficient means of providing curing for pavement concrete.
- Curing activities include controlling the temperature of the concrete during extreme weather.

Internal temperature and moisture directly influence both early and ultimate concrete properties (Taylor 2013, Kosmatka and Wilson 2016). Proper curing measures prevent premature water loss from the mixture and allow more thorough cement hydration. It is

essential to apply curing measures as early as possible after placing concrete and to continue them until enough hydration has taken place that the required hardened properties have been achieved.

A variety of curing methods and materials is available for concrete pavement, including water spray or fog, wet burlap sheets, plastic sheets, insulating blankets, and liquid membrane-forming compounds. The most common method of curing is the application of a curing compound.

Curing Compounds

The most common curing method for concrete pavements is the application of a liquid membrane-forming compound to the concrete surface. Curing compounds are organic materials that form a skin over the surface of the concrete and reduce the rate of moisture loss from the concrete ([see Curing Compounds in Chapter 4](#)). This material limits water evaporation to about 20 percent of unprotected concrete when properly applied. A liquid membrane-forming compound should meet ASTM C309/AASHTO M 148. Common application rates are given below, although rates may vary between products (ACPA 1994).

- 200 ft²/gal for normal paving applications
- 100 ft²/gal for thin overlays

Note: On dry, windy days, or during periods when adverse weather conditions could result in plastic shrinkage cracking, an application of evaporation retarders immediately after final finishing and before all free water on the surface has evaporated will help prevent the formation of cracks. Evaporation retarders should not be confused with curing compounds.

If the curing regimen is inadequate or applied too late, the concrete will be susceptible to plastic shrinkage cracking and excessive warping, curling, and scaling. Therefore, for a curing compound to be of benefit, it should be applied as soon as possible after the water sheen has left the surface and texturing is complete. The concrete surface should be damp when the compound is applied.

Power-driven spray equipment is recommended for uniform application of curing compounds on large paving projects. Spray nozzles and windshields on such equipment should be arranged to prevent wind-blown loss of curing compound. Hand-operated equipment should be used only for small areas.

Complete coverage of the surface must be attained because even small pinholes in the membrane will increase the evaporation of moisture from the concrete. Normally, only one smooth, even coat is applied. There is also evidence (Taylor 2013) that a double application is more effective than a single application, even if the total amount of material used is the same.

The curing compound should coat both the top and edges of slipformed concrete (Figure 8-27).



Jim Grove, ATI Inc./FHWA, used with permission

Figure 8-27. Curing machine coats both the top surface and sides of a slipform paving slab

For fixed-form paving, the curing compound should initially coat the exposed concrete surface. If removing forms early, a second coat is necessary to cover any exposed vertical edges of the slab to provide a complete seal.

When curing sawed joint faces, if the saw slurry is completely removed immediately after green sawing, the joint faces may be cured to facilitate the hydration process and improve long-term joint durability. While this practice may be desirable, it is not always practical, especially when the joints will be sealed without further dimension sawing, because it is difficult to properly clean the curing compound from the joint faces, which can result in inadequate bonding of the sealant material.

White pigmentation in the compound is preferable to a clear compound because the amount of coverage is easy

to see. The pigment also reflects solar radiation that may otherwise heat the concrete surface excessively.

Recommendations for curing compound application include the following (IPRF 2003):

- Apply liquid curing compounds using spray equipment mounted on a self-propelled frame that spans the paving lane
- Limit handheld sprayers for curing application on small areas
- Even though a visual check is feasible with white-pigmented curing compound, measure the volume on a given area and compare it to the specified or recommended application rate
- Apply curing compound to all exposed faces of the concrete after slipforming or after forms are removed
- When moist curing, maintain the moist condition over the entire concrete surface for the entire curing period (typically seven days) or until a curing compound is applied

A curing compound is not the same as an evaporation retarder, which is a water-based, spray-on liquid that forms a mono-molecular film over the plastic concrete surface. It is intended to be applied immediately after strike-off and/or between finishing operations to reduce the risk of plastic shrinkage cracking. Evaporation retarders will not retard the setting characteristics of the concrete, but they will minimize the amount of water loss in the concrete due to evaporation. They are useful in very dry or windy conditions, when evaporation rates are high. A curing compound (or other curing method) must still be applied subsequent to final finishing or texturing.

Evaporation retarders should not be used as finishing aids because, as they are worked into the surface of the concrete, they will elevate the water/cement ratio at the surface. This may lead to lower strengths at the surface, poor air content or air-void structure, and nondurable surface mortar.

Other Curing Methods

Plastic sheeting can be used for curing, usually as a supplement to a curing compound, to facilitate cold weather placements or to protect the freshly placed slab from rain (see [Weather](#) next). Plastic sheeting is also useful to sustain the heat of hydration and increase the strength gain because it maintains a layer of air above the surface, which acts as an insulator.

Curing blankets can also be used for curing. Proceed carefully before removing curing sheeting or blankets from a recently placed concrete pavement. If the concrete is still warm when the blankets are removed and the ambient temperature is low, thermal shock can occur, which may cause cracking (Huang et al. 2001).

Weather

Key Points

- Preparations for hot- or cold-weather paving, as well as for a rain event, should be made well in advance.
- During hot-weather paving conditions, it is critical to reduce the evaporation rate from concrete to minimize plastic shrinkage cracking.
- During cold-weather paving conditions, the primary concerns are to keep the concrete temperature above freezing so that hydration continues and to control cracking through joint placement.
- During a rain event, it is important to cover and protect the new concrete surface as well as to prepare for a possible cold front following the rain. A sudden, significant drop in temperature can increase the risk of uncontrolled cracking.
- HIPERPAV is an excellent tool for assessing the risk of early-age cracking in all weather conditions but especially in changing weather conditions such as an approaching cold front.

Hot-Weather Concreting

The American Concrete Institute (ACI) categorizes hot weather as a period when, for more than three consecutive days, the following conditions exist (ACI 2010):

- The average daily air temperature is greater than 77°F. The average daily temperature is the mean of the highest and the lowest temperatures occurring during the period from midnight to midnight.
- The air temperature for more than one-half of any 24-hour period is not less than 86°F.

Preparation for hot-weather paving should take place long before paving begins.

Whenever the construction team anticipates building a project in the summer, they should verify the concrete mixture for these conditions. Verification testing is conducted in the laboratory during the mix design phase. The testing laboratory mixes trial batches and casts specimens at temperatures representative of the site conditions to flag whether compatibility problems may arise.

During hot weather, problems that may occur include the following:

- Rapid slump loss
- Reduced air contents
- Premature stiffening
- Plastic shrinkage cracking
- Thermal cracking

During hot weather, the construction team should take steps to reduce the evaporation rate from the concrete. The likelihood of plastic shrinkage cracking increases when the evaporation rate increases. Plastic shrinkage cracking results from the loss of moisture from the concrete before initial set. The evaporation rate is a function of the following:

- Air temperature
- Concrete temperature
- Relative humidity
- Wind speed

If the evaporation rate exceeds 0.2 lb/ft²/hr, it is advisable to provide a more effective curing application such as fog spraying or to apply an approved evaporation reducer.

One or more of the following precautions can minimize the occurrence of plastic shrinkage cracking (Taylor 2013). They should be considered while planning for hot-weather concrete construction or while dealing with the problem after construction has started. The following precautions are listed in the order in which they should be done during construction:

- Moisten dry, absorptive aggregates
- Keep the concrete temperature low by cooling aggregates and mixing water

- Dampen the subgrade and fog forms before placing the concrete
- Erect temporary windbreaks to reduce wind velocity over the concrete surface
- Erect temporary sunshades to reduce concrete surface temperatures

If conditions of temperature, relative humidity, and wind are too severe (Figure 8-28) to prevent plastic shrinkage cracking, or if corrective measures are not effective, paving operations should be stopped until weather conditions improve (IPRF 2003). (See Early-Age Cracking in Chapter 6.)

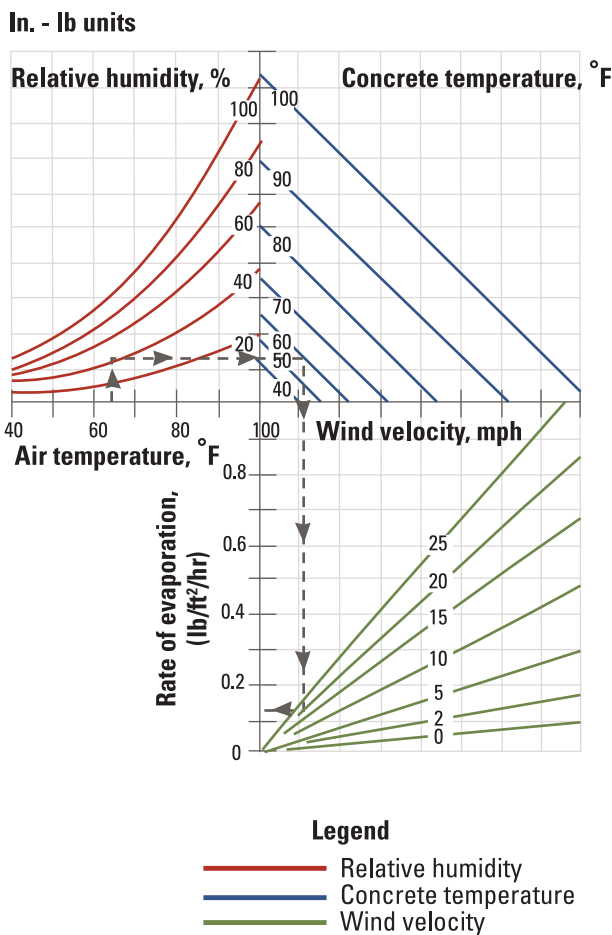

To use these charts

1. Enter with air temperature; move up to relative humidity
2. Move right to concrete temperature
3. Move down to wind velocity
4. Move left; read approximate rate of evaporation

PCA, after ACI 1999, used with permission

Figure 8-28. A nomograph to estimate the rate of evaporation

Following are general recommendations/options/considerations for hot-weather concreting (IPRF 2003):

- Do not exceed the maximum allowable w/cm ratio or the manufacturer's maximum recommended dosage of any admixture.
- Consider retarding admixtures if their performance has been verified during trial batches.
- Substitute GGBF slag or Class F fly ash for part of the portland cement. These materials hydrate more slowly and generate lower heats of hydration than cement, reducing tendencies toward slump loss, premature stiffening, and thermal cracking. Certain Class C fly ashes, with high calcium and aluminum contents, may cause premature stiffening.
- Low air contents can be corrected by increasing the dosage of AEA. Better or longer mixing may allow maintenance of a constant air-void spacing factor without a greater air content. Using additional water reducer may also be helpful.
- Risk of early-age thermal cracking is reduced by ensuring that the temperature of the plastic concrete is as low as practical.
 - Sprinkling with water may cool aggregates; be sure to correct for the aggregate moisture.
 - Aggregates need to be batched in a saturated surface-dry condition to avoid absorbing mixture water.
 - Chilling the mixing water or adding chipped ice in substitution for some of the water lowers the mix temperature. Be sure that all of the ice melts during mixing.
- Consider painting the mixing and transporting equipment white or another light color to minimize the heat absorbed from the sun.
- In extreme conditions, consider scheduling concrete placements during the evening or night.
- Moisten the base before placing the concrete to keep the temperature down and to keep it from absorbing water from the concrete.
- Place and finish the concrete as rapidly as possible to apply the curing compound at the earliest possible time. The use of a white curing compound will reflect the sun's heat. If there is any delay in applying the curing compound, use a fog spray or evaporation retardant to keep the surface from drying out.
- Refer to ACI 305, Hot Weather Concreting, for additional information.

Cold-Weather Placement

Cold weather is defined by the ACI as a period when, for more than three consecutive days, the following conditions exist (ACI 2018):

- The average daily air temperature is less than 40°F. The average daily temperature is the mean of the highest and lowest temperatures occurring during the period from midnight to midnight.
- The air temperature is not greater than 50°F for more than one-half of any 24-hour period.

Cold-weather paving requires special considerations. The contractor and material supplier should address these considerations well before temperature forecasts predict temperatures to drop close to or below freezing. The primary concern is to keep the temperature of the concrete above freezing so that the hydration reaction continues and to control cracking through joint placement.

Trial batches are needed to verify that the proposed mixtures will achieve the desired strength at the potential temperatures. Mixtures with accelerating admixtures must be treated carefully to ensure that they accelerate the setting and/or early strength gain of concrete but do not lead to workability or constructability challenges.

The following are recommendations/options/considerations for cold-weather concreting (IPRF 2003); also see Effects of Supplementary Cementitious Materials in Concrete in Chapter 4 for additional information on the impacts of SCMs during cold weather concreting:

- Consider using a higher portland cement content in concrete mixture designs for placement at cooler temperatures.
- The necessary AEA dosage will likely be lower for cold-weather concrete than for concrete designed for normal temperatures.
- An accelerating admixture conforming to ASTM C 494 Type C or E may be used, provided its performance has been previously verified by trial batches.
- Do not use admixtures containing added chlorides. Also, do not use calcium chloride.
- Aggregates must be free of ice, snow, and frozen lumps before being placed in the mixer.

- Because the concrete will take longer to set, there is more risk for plastic shrinkage cracking, especially if the concrete is much warmer than the ambient air or the wind speed is significant.
- Consider heating the mix water (if practical for the size of the pour). The temperature of the mixed concrete should not be less than 50°F. Mixtures with SCMs may need to be provided at 65°F or greater to enhance early-age strength gain.
 - The mixture water and/or aggregates may be heated to 150°F.
 - The material must be heated evenly.
- Insulating blankets also are necessary for curing concrete pavement in cool weather. The blankets reduce heat loss and lessen the influence of both air temperature and solar radiation on the pavement temperature. The blankets are not a substitute for curing compound, which is still needed to contain moisture for complete hydration.
- The concrete temperature should be maintained at 50°F or above for at least 72 hours after placement and at a temperature above freezing for the remainder of the curing time. Corners and edges are the most vulnerable to freezing.
- Concrete should not be placed when the temperature of the air at the site or the surface on which the concrete is to be placed is less than specified or as addressed in the QC plan.
- Concrete placed in cold weather gains strength slowly. Concrete containing SCMs gains strength very slowly.
 - Sawing of joints and opening to traffic may be delayed.
 - Verify the in-place strength by a maturity method, temperature-matched curing, nondestructive testing (NDT), or tests of cores from the pavement before opening the pavement to traffic.
- Allow the slabs to cool before completely removing insulating blankets to avoid a thermal shock to the pavement that might induce contraction cracking. Insulating blankets may be temporarily rolled aside to saw contraction joints.
- Refer to ACI 306, *Cold Weather Concreting*, for additional information.

Early- and Late-Season Placements

Spring and autumn placements may experience higher temperature swings through the hydration process, which can lead to the potential for early-age cracking. This is especially critical when early morning temperatures are cool and afternoon temperatures are warm (e.g., 45°F to 75°F). When these conditions occur, it may be necessary to adjust the sequence of saw timing, meaning that the areas paved midmorning may need to be sawn before the early morning section of pavement. HIPERPAV may be useful in determining which areas will experience early-age stresses during these weather conditions (see Crack Prediction with HIPERPAV in the next section of this chapter).

Protection from Rain

Plastic sheeting (Figure 8-29) and steel side forms or wooden boards must be available at all times to protect the surface and edges of the newly placed concrete pavement when it rains. If rain is expected on newly placed concrete pavement that has not hardened, cover the surface with the plastic sheeting.

The sheets must be weighted down to prevent them from blowing in the wind. When it starts raining, a “rule of thumb” to determine how much of the pavement to cover is to go back to the point where the rain is not indenting the pavement surface. The covering does not need to be extended to areas where the rain is only washing away the curing membrane (ACPA 2003b).

Climatic conditions during a rain event can actually be conducive to good concrete curing. During rain, the humidity is at or near 100 percent and there is little



ACPA, used with permission

Figure 8-29. Plastic sheeting ready for placement to protect the fresh surface from rain

chance for the evaporation of mix water. Temperatures are generally moderate during rain, which is also beneficial. In these situations, the rain essentially provides a beneficial moist curing environment, which assists with strength development and decreases the chance for uncontrolled cracking. This provides a natural cure.

Sometimes, particularly if the prevailing weather is hot and humid, rain precedes the passage of a cold front, which may drop the air temperature more than 20°F. Where this occurs, and when the pavement is under construction, the risk of uncontrolled cracking will increase (ACPA 2002). The drop in the dew point that usually occurs with a cold front may also lead to a lower relative humidity above the warm concrete and thus a greater susceptibility for plastic shrinkage cracking.

Some marring of the concrete surface may occur from the plastic sheeting used to protect the slabs from rain. Except for an undesirable appearance, there is nothing wrong with surfaces affected by plastic sheeting. A similar appearance can occur when using plastic sheeting to cure concrete. In cases where only the surface of the pavement is damaged by plastic sheeting or limited exposure to rain, diamond grinding may be used to repair the surface of the pavement affected.

Additional water on the pavement surface will elevate the surface w/cm ratio, potentially reducing durability. Do not finish rainwater into the concrete surface. This elevates the w/cm ratio, creating a nondurable top surface susceptible to crazing, scaling, and dusting (Figure 8-30).



ACPA 2003a, used with permission

Figure 8-30. Typical scaling of concrete pavement due to rain, resulting in nondurable paste surface

For slipform paving operations, it is advantageous to install side forms where severe erosion of the fresh concrete edge may occur (Figure 8-31) because of heavy rain.



ACPA 2003a, used with permission

Figure 8-31. Edge erosion of freshly placed slab due to rain

Crack Prediction with HIPERPAV

Key Points

- A number of variables influence the risk of drying shrinkage cracking in concrete:
 - Temperature
 - Rate of drying
 - Shrinkage
 - Restraint
 - Strength
 - Modulus of elasticity
 - Coefficient of thermal expansion (CTE)
- A computer program, HIPERPAV, is available to model the risk of cracking for a given mix under a given environment.

Many variables can influence the propensity of a specific concrete to crack (see [Early-Age Cracking in Chapter 6](#)). However, it is possible to numerically model the dominant mechanisms of failure to assess the risk of cracking within a given set of conditions.

Such a model has been developed for pavements by the FHWA. The resulting software package, known as HIPERPAV, is briefly described below. For more information, see www.fhwa.dot.gov/pavement/pccp/hipemain.cfm.

HIPERPAV is a commercially available computer software package. It is intended to be used by personnel involved in constructing concrete pavements and bonded overlays. Its purpose is to model and predict whether the concrete is likely to crack at an early age due to conditions unrelated to structural slab loading.

The program is also used to estimate the window of opportunity for saw cutting.

The program considers the following factors:

- Concrete pavement temperature
- Concrete CTE
- Drying shrinkage
- Slab-subbase restraint
- Modulus of elasticity
- Strength

All of these performance parameters are calculated based on complex numerical models that use the following factors as input parameters:

- Pavement design inputs
 - Subbase type
 - Slab-base friction (bond)
 - Transverse joint spacing
 - Tensile strength
 - Modulus of elasticity
 - Slab thickness
 - Mix design inputs
 - Concrete strength development
 - Portland cement type
 - Cement chemistry
 - Cement content
 - Silica fume content
 - Fly ash (Types F and C) content
 - GGBF slag content
 - Water content
 - Coarse aggregate type and content
 - Fine aggregate content
 - Water reducer content
 - Super water reducer
 - Retarder content
 - Accelerator content

- Environmental inputs
 - Air temperature
 - Relative humidity distribution
 - Cloud conditions
 - Moisture conditions
 - Wind speed
- Construction inputs
 - Curing method
 - Time of curing application
 - Time of curing removal
 - Time of construction
 - Time of saw cutting
 - Initial portland cement concrete
 - Mix temperature
 - Initial subbase temperature

The output of the HIPERPAV program is a plot of allowable stress (developed strength anticipated) in the concrete and the predicted stress over a period of 72 hours (see Figure 8-32).

If the predicted stress exceeds the allowable stress, cracking is indicated as likely and changes need to be made to the concrete mix or construction practices, and/or protection must be provided from the environment.

The HIPERPAV package has been validated for a range of designs, materials, and climatic conditions at several sites in the US. Pavements under construction

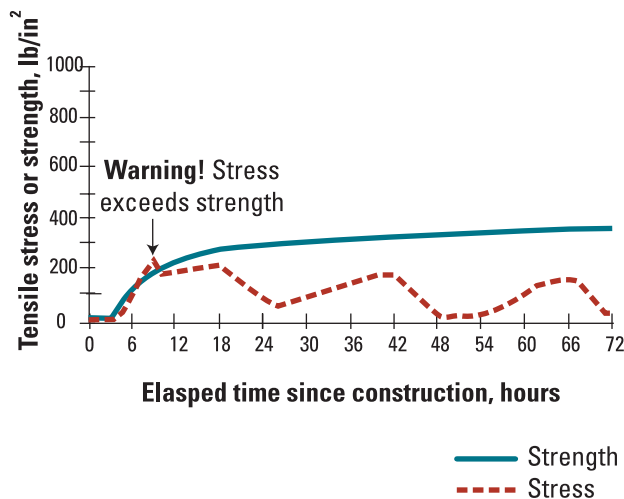

Figure 8-32. An example plot reported by HIPERPAV showing a high risk of cracking at about six hours after paving

were instrumented and the data were compared with the predictions made by the program. The system was found to predict crack formation with an accuracy of approximately five hours.

Joint Sawing

Key Points

- Joints are required to control cracking in a concrete pavement.
- Joints can be saw cut after the concrete has been placed.
- It is critical to cut the joints at the right time—too early will result in raveling, too late will take place after random cracking occurs.
- The timing of saw cutting is dependent on concrete properties and the environment.

Like all materials, concrete expands and contracts with variations in temperature and moisture content, which can cause cracking if it is restrained. Cutting the pavement into smaller elements helps relieve the restraint and generally ensures that the cracks form where desired rather than at random ([see Early-Age Cracking in Chapter 6](#)).

Concrete slabs crack when tensile stresses within the concrete overcome the tensile strength. At early ages, the tensile stresses develop from restraint of the concrete's volume change or restraint of slab bending from temperature and moisture gradients through the concrete (Okamoto et al. 1994). Early volume changes are associated with the concrete's drying shrinkage and temperature contraction. Each transverse and longitudinal saw cut induces a point of weakness where a crack will initiate and then propagate to the bottom of the slab.

In most cases, cracks first appear at large intervals, 30 to 150 ft, and then form at closer intervals over time. Intermediate sawed joints, normally required to control cracking from differentials, sometimes do not crack for several weeks to months after opening the pavement to traffic. However, this may not be true on every pavement, and it may be very difficult to determine whether restraint to volume changes or restraint to temperature or moisture gradients cause the first cracks.

A fundamental of jointed concrete pavement design is to introduce a jointing system to control the location of this expected cracking. Of the three joint types—contraction, construction, and isolation—contraction joints are specifically for crack control. For unreinforced concrete pavement, joint spacing or slab length depends upon slab thickness, concrete aggregate, subbase, and climate (ACPA 1991). In most areas, the typical maximum transverse joint spacing for unreinforced (plain) pavement is about 15 ft (ACPA 2013). Longitudinal joints are typically about 10 to 13 ft apart and serve the dual purpose of crack control and lane delineation.

The climate and concrete coarse aggregate common to some geographic regions may allow transverse joints to be further apart or require them to be closer together than the average. For example, concrete made from granite and limestone coarse aggregate is much less sensitive to temperature change than concrete made from siliceous gravel, chert, or slag aggregate. A less temperature-sensitive concrete does not expand or contract much with temperature change, which allows a longer spacing between pavement contraction joints without a greater chance of random cracking.

Various kinds of saws can be used for cutting joints. For most projects, transverse or longitudinal contraction joints are cut with single-blade, walk-behind saws (Figure 8-33[a]). For wider paving, contractors may elect to use span-saws (Figure 8-33[b]) that are able to saw transverse joints across the full pavement width in one pass. A newer class of saw, the early-entry dry saw (Figure 8-33[c]), is a walk-behind saw that allows sawing sooner than with conventional saws.

Saw Timing

There is an optimum time to saw contraction joints in new concrete pavements. That time occurs within the sawing window (see Figure 8-34).

When Can You Begin Sawing Joints?
<p>To determine when the concrete is ready to cut using conventional sawing techniques, use the scratch test. Scratch the concrete surface with a nail or knife blade. As the surface hardens, the scratch depth decreases. In general, if the scratch removes the surface texture, it is probably too early to saw. Measuring the initial set of the concrete on site can also be used to predict when sawing should occur (Wang 2016).</p>

a) Single-blade, walk-behind saw



b) Span-saw



c) Early-entry, walk-behind dry saw



Jim Grove, ATI Inc./FHWA, used with permission

Figure 8-33. Common sawing equipment

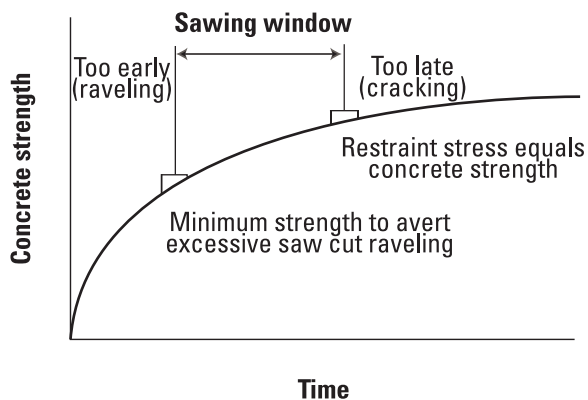

Okamoto et al. 1994

Figure 8-34. Sawing window

The window is a short period after placement when the concrete pavement can be cut to successfully control crack formation (see the [Stages of Hydration charts](#) and [Concrete Strength Gain, Tensile Stress, and the Sawing Window](#) in [Chapter 5](#)). The window begins when concrete strength is sufficient for sawing without excessive raveling along the cut. The sawing window ends when random cracking starts to occur.

Sawing too early causes the saw blade to break or pull aggregate particles free from the pavement surfaces along the cut. The resulting jagged, rough edges are termed raveling. Some raveling is acceptable where a second saw cut would be made for a joint sealant. If the raveling is too severe, it will affect the appearance and/or the ability to maintain the joint. Figure 8-35 shows different degrees of raveling.

One study (Okamoto et al. 1994) found that raveling was within acceptable limits when the concrete compressive strengths were from 300 to 1,015 lb/in², depending on the type of aggregate used in the mixture. Refinement of a specific strength threshold number to be used on a project would require trial-and-error testing of the job materials using the concrete maturity principle. Taylor and Wang have employed an approach of using the speed of sound through a sample exposed to the weather on site to measure the initial set and thus predict when sawing should occur (Wang 2016). Correlation across a number of sites over a range of temperatures was remarkably good.

The length of the sawing window depends on many factors and is likely to be different for each project and each day of construction. Certain design features,

a) No raveling—sawed later in the window



b) Moderate raveling—sawed early in the window



c) Unacceptable raveling—sawed too early



ACPA, used with permission

Figure 8-35. Close-up of different degrees of raveling caused by joint sawing

materials, or weather conditions can considerably shorten the window (Table 8-7).

Under most weather conditions and for typical pavement designs, the window will be long enough to complete sawing with excellent results. In extreme conditions, the window can be so short as to be impracticable for crack control. Concrete maturity testing helps indicate the influence of ambient conditions on the concrete strength profile and consequently helps define the sawing window. Other tools include the FHWA's HIPERPAV software, which can help determine saw timing and predict the possibility of uncontrolled cracking (McCullough and Rasmussen 1999).

Early-entry saws are now used on some paving projects. Smaller and lighter than conventional saws, they have the advantage of allowing sawing to begin within an hour or two of paving. The cut is in an upward direction and the concrete surface is held in place by a shoe that the blade runs through. The sawing window for early-entry saws begins earlier and ends sooner than for conventional saws (see [Figure 5-2](#)).

Table 8-7. Factors that shorten the sawing window

Category	Factor
Concrete mixture	High water demand
	Rapid early strength
	Retarded set
	Fine aggregate (fineness and grading)
	Coarse aggregate (maximum size and/or percentage)
Weather	Sudden temperature drop or rain shower
	Sudden temperature rise
	High winds and low humidity
	Cool temperatures and cloudy
	Hot temperatures and sunny
Subbase	High friction between the subbase and concrete slab
	Bond between the underlying subbase and concrete slab
	Dry surface
	Porous aggregate subbase materials
Miscellaneous	Paving against or between existing lanes
	Saw blade selection
	Delay in curing protection

Source: ACPA 2002

First-generation early-entry saws were designed to cut shallow (1 in.) joints. At final set (the beginning of the sawing window for early-entry saws), a shallow joint is enough to create a plane of weakness where a crack will form to relieve stresses as the pavement builds strength. Early, shallow cuts work well for transverse joints, regardless of the thickness of the pavement. Critical to the successful use of an early-entry saw is the use of a blade appropriate for the materials in use (particularly the coarse aggregate) and that the shoe used to hold the concrete in place is clean and working properly.

Longitudinal joints should be cut immediately after the transverse joints. By this time, the concrete has developed more strength, and a deeper cut is required to effectively create a plane of weakness. Therefore, first generation early-entry saws are not normally used for longitudinal joints. Today, both early-entry and conventional saws can cut longitudinal joints to the required one-third depth of the slab.

Note about joint width: Because transverse joints move, they typically are sealed to prevent the infiltration of water and foreign matter. The saw cuts (whether early-entry or conventional) must therefore be nominally ¼ in. wide to form adequate reservoirs for the sealant. Because longitudinal joints are tied and thus designed not to move, many states do not seal them. The saw cuts can therefore be narrow (⅛ in.). With granular bases and subdrains, any water entering longitudinal joints should effectively drain away.

Mixture Effects

Regardless of other related factors, the concrete mixture itself is a primary factor in defining the potential to control cracking with a jointing system.

The primary influences of the mixture are the following:

- Paste content
- W/cm ratio
- Type of cementitious materials
- Aggregate type

The volume of shrinkage is directly controlled by the total water content, which is a function of cementitious content and w/cm ratio. Increased water content increases shrinkage. On the other hand, the greater the strength, the better able the concrete is to resist shrinkage-induced stresses.

Mixtures containing fly ash, slag cement, or blended cement may experience a delay in early-age strength

development, especially in cooler weather. This could delay the concrete set time and the ability to saw without some raveling. After setting, the time available for sawing before cracking begins may be shorter than normal. This decrease in available sawing time increases the risk of uncontrolled cracking in cooler weather.

The geology of the coarse aggregate may affect when sawing may start because siliceous-based materials tend to be harder than calcareous, meaning that sawing may have to occur a little later to prevent raveling.

Joint Sealing

Key Points

- Joints are filled with sealant to prevent ingress of deleterious materials.
- Many alternative sealant systems are available.
- Sealant material selection considerations include the environment, cost, performance, joint type, and joint spacing.
- Some agencies do not require joint sealing/filling (for guidance regarding this design option, see the Seal/No Seal Group website at <http://sealnoseal.org/news.htm>).

The purpose of sealing joints is to minimize infiltration of surface water and incompressible material into the pavement layers (ACPA 2018). Excess water can contribute to subgrade or base softening, erosion, and pumping of subgrade or base fines over time. This degradation results in a loss of structural support, pavement settlement, and/or faulting.

There are many acceptable materials available for sealing joints in concrete pavements. Sealants are either placed in a liquid form or are preformed and inserted into the joint reservoir. Sealants installed in a liquid form depend on long-term adhesion to the joint face for successful sealing. Preformed compression seals depend on lateral rebound for long-term success. For more specific information on joint sealing materials and required shape factors and sizes, consult ACPA (2018).

Sealing prevents incompressible objects from entering joint reservoirs. Incompressibles contribute to spalling and, in extreme cases, may induce blow-ups. In either case, excessive pressure along the joint faces results as incompressibles obstruct pavement expansion in

hot weather. Years ago, the term joint fillers described liquid asphalt materials placed in joints. Joint fillers aid more in keeping out incompressibles than minimizing water infiltration.

Sealant material selection considerations include the following (Table 8-8):

- Pavement use
- Environment
- Cost
- Performance
- Joint type and spacing

The following list includes common factors for which the concrete material or installation technique affects the joint seal performance:

- Inadequate cleaning of the joint faces inhibits proper adhesion of the sealant.
- Silicone sealants are known to have poor adhesion to concrete containing dolomitic limestone. A primer

application to the sealant reservoir walls will ensure that the silicone adheres.

- Concrete containing harder coarse aggregates, such as gravel or granite, will expand and contract more with a given temperature change than a concrete containing limestone. The sealant will be stretched farther for a given joint spacing. To keep this under control, use an appropriate shape factor for sealant (Figure 8-36).
 - Hot-poured asphalt-based sealants typically need a reservoir shape factor (width/depth ratio) of 1.
 - Silicone and two-component, cold-poured sealants typically need a reservoir shape factor of 0.5.
 - Compression sealants are selected such that the maximum compression of the seal is 50 percent and the minimum is 20 percent through the anticipated ambient temperature cycles in the area. Maintaining a uniform saw cut width is critical to good performance.

Table 8-8. Potential joint performance based on sealing option

	STREETS/ROADS/HIGHWAYS							
	Any posted speed limit (unless indicated by note)							
	Dense-graded base or subgrade soil				Nonerodible (2) or free-draining layer (3)			
Layer below slab								
Climatic zone	Dry no-freeze		Other		Dry no-freeze		Other	
Joint spacing	≤ 6 ft	> 6 ft	≤ 6 ft	> 6 ft	≤ 6 ft	> 6 ft	≤ 6 ft	> 6 ft
Open reservoir cut	NR	NR	NR	NR	NR	NR	NR	NR
Open narrow saw cut	■	■	■	NR	■	■	■ (4,5)	■ (5)
Filled saw cut or reservoir	■	■	■ (6)	■ (6)	■	■	■ (6)	■ (6)
Sealed saw cut or reservoir	■	■	■	■	■	■	■	■

KEY:

NR = Not recommended

■ Should perform adequately based on engineering judgment and limited experience (if sealed/filled, then also with correct installation/maintenance procedures)

■ Will perform adequately based on engineering judgment and limited experience (if sealed/filled, then also with correct installation/maintenance procedures)

Source: ACPA 2018

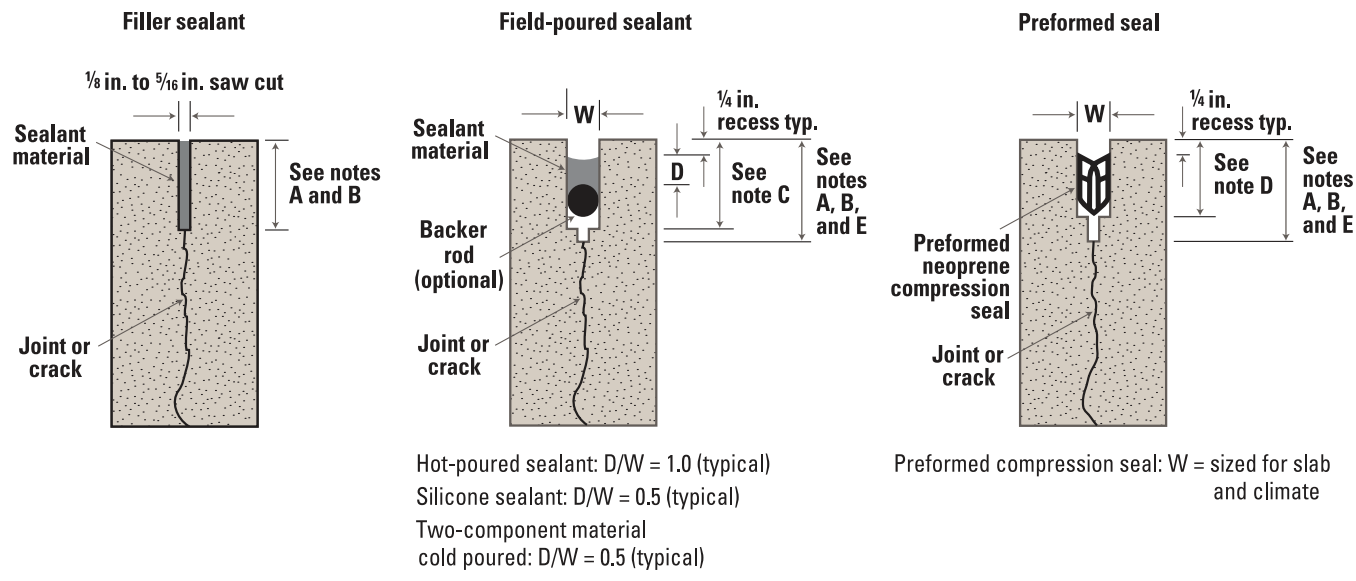

Notes:
 A - Initial cut to a depth of T/4 or T/3 as required for conventional sawing.
 B - Initial cut to a depth of 1 1/4 in. minimum for early-entry sawing.
 C - As required to accommodate sealant and backer rod.
 D - As required by the manufacturer.
 E - A single-cut or double-cut process may be used to saw joints.
 The field-poured sealant and performed seal above illustrate a double cut, in which a first, narrow cut is followed by a widening cut. A single wide cut is also acceptable.

Adapted from ACPA, used with permission

Figure 8-36. Different forms of joint sealant

- Chemical solvents used to clean the joint reservoir may be detrimental. Solvents can carry contaminants into pores and surface voids on the reservoir faces that will inhibit bonding of the new sealant.
- For cleaning joints, the air stream must be free of oil. Many modern compressors automatically insert oil into the air hoses to lubricate air-powered tools. New hoses or an oil and moisture trap prevent contamination of the joint face from oil in the compressor or air hoses.

Above all, the most critical aspect in sealant performance is reservoir preparation. A considerable investment in joint preparation and cleaning activities is necessary for almost all sealant types. There is little doubt that poorly constructed joints will perform poorly. Proper cleaning requires mechanical action and pure water flushing to remove contaminants. The following outlines the recommended procedures (ACPA 1993):

- Immediately after wet sawing, a water wash removes the slurry from the sawing operation. Contractors perform this operation in one direction to minimize contamination of surrounding areas.

- After the joint has sufficiently dried, a sandblasting operation removes any remaining residue. Do not allow sandblasting straight into the joint. Holding the sandblast nozzle close to the surface at an angle to clean the top 1 in. of the joint face provides cleaning where needed. One pass along each reservoir face provides excellent results. This not only cleans the joint faces, but also provides texture to enhance sealant adhesion.
- An air-blowing operation removes sand, dirt, and dust from the joint and pavement surface. Conducting this operation just prior to sealant pumping ensures that the material will enter an extremely clean reservoir. The contractor must provide assurance that the air compressor filters moisture and oil from the air. The compressor should deliver air at a minimum 120 ft³/min and develop at least 90 lb/in² nozzle pressure. Some contractors also use a vacuum sweeper and hand brooms to keep the surrounding pavement clean.

References

AASHTO M 148 *Standard Specification for Liquid Membrane-Forming Compounds for Curing Concrete.*

AASHTO M 157 *Standard Specification for Ready-Mixed Concrete.*

AASHTO T 96 *Standard Method of Test for Resistance to Degradation of Small-Size Coarse Aggregate by Abrasion and Impact in the Los Angeles Machine.*

AASHTO T 99 *Standard Method of Test for Moisture-Density Relations of Soils Using a 2.5-kg (5.5-lb) Rammer and 305-mm (12-in.) Drop.*

AASHTO T 180 *Standard Method of Test for Moisture-Density Relations of Soils Using a 4.54-kg (10-lb) Rammer and 457-mm (18-in.) Drop*

ASTM C94/C94M-04a *Standard Specification for Ready-Mixed Concrete.*

ASTM C131-03 *Standard Test Method for Resistance to Degrading of Small-Size Coarse Aggregate by Abrasion and Impact in the Los Angeles Machine.*

ASTM C309-03 *Standard Specification for Liquid Membrane-Forming Compounds for Curing Concrete.*

ASTM C494/C494M-04 *Standard Specification for Chemical Admixtures for Concrete.*

ASTM D698-00a *Standard Test Methods for Laboratory Compaction Characteristics of Soil Using Standard Effort (12,400 ft-lb/ft³ (600 kN-m/m³)).*

ASTM D1557-02e1 *Standard Test Methods for Laboratory Compaction Characteristics of Soil Using Modified Effort (56,000 ft-lb/ft³ (2,700 kN-m/m³)).*

ASTM D1883-99 *Standard Test Method for CBR (California Bearing Ratio) of Laboratory-Compacted Soils.*

ASTM D3152-72 (2000) *Standard Test Method for Capillary-Moisture Relationships for Fine-Textured Soils by Pressure-Membrane Apparatus.*

ASTM D4546-03 *Standard Test Methods for One-Dimensional Swell or Settlement Potential of Cohesive Soils.*

ASTM D4829-03 *Standard Test Method for Expansion Index of Soils.*

CALTRANS Test 354 *Method of Test for Evaluating the Expansive Potential of Soils Underlying Portland Cement Concrete Pavements (Third Cycle Expansion Pressure Test).*

ACI. 1999. *Hot Weather Concreting.* ACI 305R-99. American Concrete Institute, Farmington Hills, MI.

———. 2018. *Concrete Terminology.* ACI CT-18. American Concrete Institute, Farmington Hills, MI. <https://www.concrete.org/store/productdetail.aspx?ItemID=CT18&Format=DOWNLOAD &Language=English&Units=US Units>.

ACPA. 1991. *Design and Construction of Joints for Concrete Highways.* TB010P. American Concrete Pavement Association, Skokie, IL.

———. 1993. *Joint and Crack Sealing and Repair for Concrete Pavements.* TB012P. American Concrete Pavement Association, Skokie, IL.

———. 1994. *Fast Track Concrete Pavements.* TB004P. American Concrete Pavement Association, Skokie, IL.

———. 1995. *Subgrades and Bases for Concrete Pavements.* TB011.02P. American Concrete Pavement Association, Skokie, IL.

———. 2002. *Early Cracking of Concrete Pavement—Causes and Repairs.* TB016.01P. American Concrete Pavement Association, Skokie, IL.

———. 2003a. *Constructing Smooth Concrete Pavements.* TB006.02P. American Concrete Pavement Association, Skokie, IL.

———. 2003b. *How to Handle Rained-On Concrete Pavement.* R&T Update 4.04. American Concrete Pavement Association, Skokie, IL.

———. 2004. *Clay Ball Prevention and Repair: Stockpile Management is Key.* R&T Update 5.04. American Concrete Pavement Association, Skokie, IL.

———. 2005. *Dowel Basket Tie Wires: Leaving Them Intact Does Not Affect Pavement Performance.* R&T Update 6.01. American Concrete Pavement Association, Skokie, IL.

———. 2010. *Concrete Pavement Field Reference: Paving.* EB238P. American Concrete Pavement Association, Rosemont, IL.

———. 2013. *Database of State DOT Concrete Pavement Practices.* American Concrete Pavement Association, Skokie, IL. [http://overlays.acpa.org/Concrete Pavement/Technical/State Practices/Instructions.asp](http://overlays.acpa.org/Concrete%20Pavement/Technical/State%20Practices/Instructions.asp).

———. 2018. *Concrete Pavement Joint Sealing/Filling*. TB010-2018. American Concrete Pavement Association, Rosemont, IL. <http://www.acpa.org/wp-content/uploads/2018/04/JoiningSealing-TB010-18.pdf>.

Ayers, M., J. McDaniel, and S. Rao. 2000. *Construction of Portland Cement Concrete Pavements*. Participant's Workbook. FHWA HI-02-018. National Highway Institute, Federal Highway Administration, Washington, DC.

Bureau of Reclamation. 1988. *Earth Manual, Part 1*. Third Edition. U. S. Department of the Interior, Bureau of Reclamation, Earth Sciences and Research Laboratory, Denver, CO.

CP Road Map. 2010. *MAP Brief 5-1: Stringless Concrete Paving*. National Concrete Pavement Technology Center, Iowa State University, Ames, IA. <http://www.cproadmap.org/publications/MAPbrief5-1.pdf>.

Farny, J. A. 2001. *Concrete Floors on Ground*. Third Edition. Portland Cement Association, Skokie, IL.

Fick, G., D. Merritt, P. Taylor, T. Hanke, H. Torres, and R. Rasmussen. 2018. *Implementation Support for Second Strategic Highway Research Program (SHRP2) Renewal R06E: Real-Time Smoothness Measurements on Portland Cement Concrete Pavements During Construction*. National Concrete Pavement Technology Center, Iowa State University, Ames, IA.

Huang, H., C. A. Beckemeyer, W. S. Kennedy, and L. Khazanovich. 2001. Finite Element Modeling of Cracking in Fast-Track Full Depth PCC Repairs. Paper submitted for *80th Annual Meeting of the Transportation Research Board*, Washington, DC.

IGGA. 2015. *The Next Generation Concrete Surface (NGCS)*. West Coxsackie, NY. https://www.igga.net/wp-content/uploads/2018/08/FSFeb2015_Next_Generation_Concrete_Surface_NGCS.pdf.

IPRF. 2003. *Evaluation, Design, and Construction Techniques for the Use of Airfield Concrete Pavement as Recycled Material for Subbase*. Innovative Pavement Research Foundation, Skokie, IL.

Khazanovich, L., K. Hough, and M. B. Snyder. 2009. *NCHRP Report 637: Guidelines for Dowel Alignment in Concrete Pavements*. National Cooperative Highway Research Program, Washington, DC.

Kosmatka, S. and M. Wilson. 2016. *Design and Control of Concrete Mixtures*. 16th Edition. Portland Cement Association, Skokie, IL.

McCullough, B. F. and R. O. Rasmussen. 1999. *Fast-Track Paving: Concrete Temperature Control and Traffic Opening Criteria for Bonded Concrete Overlays Volume II: HIPERPAV User's Manual*. FHWA-RD-98-168. Federal Highway Administration, Turner-Fairbank Highway Research Center, McLean, VA.

Okamoto, P. A, P. J. Nussbaum, K. D. Smith, M. I. Darter, T. P. Wilson, C. L. Wu, and S. D. Tayabji. 1994. *Guidelines for Timing Contraction Joint Sawing and Earliest Loading for Concrete Pavements, Volume I*. FHWA-RD-01-079. Federal Highway Administration, Turner-Fairbank Highway Research Center, McLean, VA.

Rasmussen, R.O., P. D. Weigand, G. J. Fick, and D. S. Harrington. 2012. *How to Reduce Tire-Pavement Noise: Better Practices for Constructing and Texturing Concrete Pavement Surfaces*. National Concrete Pavement Technology Center, Ames, IA.

Reeder, G. D. and G. A. Nelson. 2015. *Implementation Manual—3D Engineered Models for Highway Construction: The Iowa Experience*. National Concrete Pavement Technology Center, Iowa State University, Ames, IA.

Snyder, M. B., T. L. Cavalline, G. Fick, P. Taylor, and J. Gross. 2018. *Recycling Concrete Pavement Materials: A Practitioner's Reference Guide*. National Concrete Pavement Technology Center, Iowa State University, Ames, IA.

Taylor, P. C. 2013. *Concrete Curing*. CRC Press, Boca Raton, FL.

Tymkowicz, S. and R. Steffes. 1999. *Vibration Study for Consolidation of Portland Cement Concrete*. Iowa Department of Transportation, Project Development Division, Ames, IA.

Wang, X, P. Taylor, and X. Wang. 2016. Comparison of Setting Time Measured Using Ultrasonic Wave Propagation with Saw-Cutting Times on Pavements—A Case Study. Paper presented at the *11th International Conference on Concrete Pavements*, August 28–September 1, San Antonio, TX.

Chapter 9

Quality and Testing

Quality Assurance	244
Monitoring the Mixture	247
Monitoring Construction Activities	251
Test Methods	254
References	272

Key Points

- Quality assurance (QA) is (1) “all those planned and systematic actions necessary to provide confidence that a product or facility will perform satisfactorily in service; or (2) making sure the quality of a product is what it should be. QA addresses the overall process of obtaining the quality of a service, product, or facility in the most efficient, economical, and satisfactory manner possible. Within this broad context, QA includes the elements of quality control (QC), independent assurance, acceptance, dispute resolution, laboratory accreditation, and personnel certification” (TRB 2013).
- QC is “the system used by a contractor to monitor, assess, and adjust their production or placement processes to ensure that the final product will meet the specified level of quality. QC includes sampling, testing, inspection, and corrective action (where required) to maintain continuous control of a production or placement process” (TRB 2013).
- Test laboratories must be appropriately certified by the agency or American Association of State Highway Transportation Officials (AASHTO) (or equivalent) and meet the requirements of ASTM C1077.
- QA and QC personnel who do testing must receive proper training. Most agencies require technicians to be certified (American Concrete Institute [ACI], National Institute for Certification in Engineering Technologies).
- Many tests performed on concrete have varying levels of precision. Open communication and cooperation between QC and QA organizations is important to avoid and resolve conflicts.
- Thorough record keeping allows for interpreting data, making informed decisions, and troubleshooting problems that may arise in the future.

This chapter discusses QA and QC systems as they influence concrete pavement, with special emphasis on materials. The chapter also describes actions that are needed to monitor and adjust for critical parameters, such as the water/cementitious materials (w/cm) ratio, air-void system, and risk of cracking. Finally, tests commonly used to monitor the materials and concrete quality are described. These descriptions do not represent all QC tests discussed throughout this manual. Rather, they have been identified as current best practices in the *Standard Practice for Developing Performance Engineered Concrete Pavement Mixtures* (AASHTO PP 84).

Quality Assurance

QA is an umbrella term covering the shared responsibilities of both the contractor and the agency for achieving a project’s specified level of quality. Under the umbrella, the primary categories of responsibilities include the following (FHWA 2012):

- QC activities performed by the contractor
- Acceptance activities performed by the local public agency

Acceptance

For most contracts, QA is associated with acceptance testing by the owner. Emphasis is normally placed on strength, thickness, smoothness, and air content because it is easy to compare these test results to specified values and determine whether the criteria have been satisfied. Other quality factors that are often overlooked because they are not as easily measured include steel placement for joints, air-void structure, permeability, and curing.

Acceptance testing may also be performed by contractor personnel, but then independent testing is needed for verification (23 CFR 637). This is especially important when statistical acceptance procedures, such as percent within limits (PWL) specifications, are used.

Most of these specifications are based on the assumption that data from a property being tested are normally distributed. The average and standard deviation (variability) of test results are then used to estimate the percent of material that is within the specified limits. Since a portion of the overall standard deviation is due to testing variability, the contractor’s payment can be influenced by testing variability that is beyond their control.

Acceptance methods that include criteria that are at least partially based on standard deviation should not penalize contractors if they are not allowed the opportunity to be in control of all factors that contribute to the overall variability. Whether explicitly stated or not, PWL specifications reward reduced variability. This can be accomplished by producing more consistent concrete and attempting to reduce testing variability. Reducing testing variability may be as easy as simply having the same technician perform the same test for all of the samples included in a given lot of pavement.

Quality Control

Under the umbrella of QA, QC is the contractor's responsibility. This work focuses on the process of batching, placing, and finishing the pavement to be sure that the pavement will meet or exceed acceptance criteria. The Federal Highway Administration (FHWA) has defined QC as "the system used by a contractor to monitor, assess, and adjust their production or placement processes to ensure that the final product will meet the specified level of quality. QC includes sampling, testing, inspection, and corrective action (where required) to maintain continuous control of a production or placement process" (TRB 2013).

QC is not an exercise in mirroring acceptance tests and may entail additional testing to be sure that the mixture is on track to achieve required performance when acceptance tests are conducted. Materials and processes are monitored at all stages of the batching and paving process to preempt problems or variations rather than simply react to them. A comprehensive QC program encompasses all aspects of the concrete paving process:

- Training of all contractor personnel: Every person on the project contributes to quality.
- Preliminary material testing: Test material before it is batched.
- Equipment and process monitoring: Develop checklists, procedures, and responses to prevent quality deficiencies.
- Testing of concrete and individual materials during trial batching and production.

QC should focus on collecting and responding to timely and early test results (real-time whenever practical). A QC plan is required to ensure that QC activities are carefully planned, sufficient, and consistent.

The plan should provide a detailed description of the type and frequency of inspection, sampling, and testing to measure the various properties described in the specification (FHWA 2012).

Results in the Transportation Pooled Fund TPF 5(066) *Material and Construction Optimization for Prevention of Premature Pavement Distress in PCC Pavements* final report provide a starting point for alternative and new test methods that can be used for QC purposes (Grove et al. 2008). The research project identified a suite of tests considered to be the current best practices. Summary sheets describing the why and how of each test are provided later in this chapter. These summaries can be used for guidance in determining which tests may be useful in the design of a QC program for constructing durable concrete pavements.

Quality of Testing

All personnel involved with QA and QC must receive proper training. Laboratories should be certified by AASHTO (or equivalent) and meet the requirements of ASTM C1077. Most agencies require certification for technicians (e.g., ACI, National Institute for Certification in Engineering Technologies).

A thorough understanding of test procedures is necessary. Just as important, however, is the knowledge that many tests performed on concrete have varying levels of precision.

Disputes and disagreements often stem from differing test results between an owner's laboratory and a contractor's laboratory. When two technicians split a sample of concrete and the resulting flexural strength results differ by 90 lb/in², which test is correct? Assuming that both tests were performed according to the prescribed test method (ASTM C 78-02), both answers are correct—neither is more right than the other.

The nature of the materials and the tests is such that test results are estimates of actual pavement properties. From the owner's perspective, it is imperative to understand that each test has an inherent level of precision and variability; a single test result may not represent the true condition of the pavement. From a contractor's perspective, this implies that the mix should be designed to accommodate testing variability in order to meet specified tolerances.

At a minimum, marginal test results should be evaluated or examined with the precision and bias associated with that test method (Table 9-1).

The values shown for the 95 percent confidence limits represent the acceptable range of difference between two tests from the same sample, prepared and tested by different technicians (d2s).

One way to interpret each of the example test results in Table 9-1 is to say that you can be 95 percent confident that the true value of the material being tested is between the lower and upper limits shown. In other words, there is a range of values associated with each test result. The range depends on the precision of each test method.

Open communication and cooperation between QC and QA organizations is important to avoid and resolve conflicts.

Record Keeping

Proper documentation of QC and QA tests is a key factor for interpreting data, making informed decisions, and troubleshooting problems that may arise in the future. Test data can become overwhelming on moderate to large concrete paving projects. Without clear and accurate data, process control adjustments cannot be made with confidence.

Table 9-1. Examples of testing precision

Test	95% lower limit	Sample result	95% upper limit
Sieve analysis (passing ½ in.)	22%	28%	34%
Slump	½ in.	1¼ in.	2 in.
Air content	4.7%	5.5%	6.3%
Unit weight	142.7 lb/ft ³	145.0 lb/ft ³	147.3 lb/ft ³
Compressive strength	3,100 lb/in ²	3,600 lb/in ²	4,100 lb/in ²
Flexural strength	565 lb/in ²	700 lb/in ²	835 lb/in ²

Some primary elements of a good record-keeping system include the following:

- A plan to respond to trends reported by the data
- Consistent and clear labeling/identification of samples
- Accurate sample location (centerline survey station) and/or time of sampling
- Legible handwriting on testing worksheets
- Organized filing system

Statistical control charts are useful tools for analyzing changes in materials and the paving process. Practically any variable that is measured in concrete paving can be plotted on a control chart. An example of test data for concrete unit weight is shown in Table 9-2.

Table 9-2. Sample concrete unit weight test results

Sample ID	Unit weight (lb/ft ³)
1-1	150.3
1-2	151.0
1-3	148.0
1-4	150.7
1-5	151.7
1-6	148.6
2-1	147.4
2-2	149.2
2-3	147.1
2-4	149.8
2-5	147.2
2-6	147.9
3-1	147.3
3-2	148.0
3-3	150.7
Average	149.0
Standard deviation	1.6

The corresponding control chart for that unit weight data is shown in Figure 9-1.

Figure 9-1 is a plot of sample concrete unit weight test results. Each point is a test result (Sample ID). The green horizontal line represents the mean of the test results. The dashed horizontal lines are drawn at intervals of one and two times the standard deviation on both sides of the mean. The solid red horizontal lines are the upper and lower control limits and are placed three standard deviations away on each side of the mean.

Standard criteria can be used to determine if an out-of-control condition exists. These criteria are as follows (Seward et al. 2004):

- Any one point is outside of the control limits (more than three standard deviations from the average)
- Nine points in a row are on the same side of the mean
- Six points in a row are all increasing or all decreasing
- Fourteen points in a row are alternating up and down
- Two out of three points are more than two standard deviations from the mean (and on the same side of the mean)

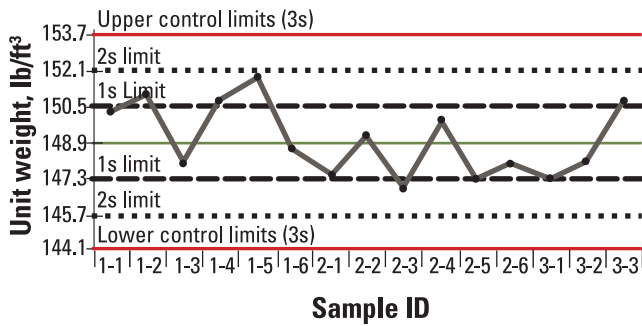

Figure 9-1. Sample control chart: concrete unit weight

- Four out of five points are more than one standard deviation from the mean (and on the same side of the mean)
- Fifteen points in a row are all within one standard deviation of the mean
- Eight points in a row are all more than one standard deviation from the mean (on either side of the mean)

Once an out-of-control condition is identified using these criteria, the process must be analyzed to determine the cause of the variability and appropriate action must be taken to correct the process.

Monitoring the Mixture

The activities to evaluate and monitor the mixture will differ depending on the phase of the work. The philosophy behind the Performance Engineered Mixtures (PEM) program is to thoroughly understand how the mixture performs during the proportioning/prequalification phase. A recommended suite of tests is provided in Table 9-3.

Table 9-3. Recommended laboratory tests during prequalification of a mixture

Concrete property	Test description	Test method	Comments
Workability	Aggregate gradation	ASTM C136/AASHTO T 27 ASTM C566/AASHTO T 255	<ul style="list-style-type: none"> Use the individual gradations and proportions to calculate the combined gradation
	Combined gradation	Tarantula curve	<ul style="list-style-type: none"> Adjust combined gradation to achieve optimum workability
	Paste content	Batch sheet	<ul style="list-style-type: none"> Adjust paste content to find minimum paste needed while still workable Confirm that total is below maximum permitted for shrinkage
	VKelly or Box	AASHTO TP 129/PP 84 X2	<ul style="list-style-type: none"> Confirm that the mixture responds well to vibration Adjust aggregate gradation and water content to achieve desired performance
	Slump at 0, 5,10,15, 20, 25, and 30 minutes	ASTM C143/AASHTO T 119	<ul style="list-style-type: none"> Look for excessive slump loss due to incompatibilities, which is more likely at elevated temperatures Determine approximate water-reducing admixture (WRA) dosage
	Segregation	—	<ul style="list-style-type: none"> Look for signs of segregation in the slump samples
Air void system	Foam drainage	—	<ul style="list-style-type: none"> Assess stability of the air-void system for the cementitious/admixture combination proposed Select alternative admixture combinations if instability is observed
	Air content	ASTM C231/AASHTO T 152, T 196	<ul style="list-style-type: none"> Determine approximate air-entraining admixture (AEA) dosage
	Super Air Meter (SAM)	AASHTO TP 118	<ul style="list-style-type: none"> < 0.2 target
	Clustering	Retemper a sample and use optical microscopy to assess clustering	<ul style="list-style-type: none"> This can affect strength Air content can also jump with retempering
	Hardened air	ASTM C457	<ul style="list-style-type: none"> Assess compliance with specification
Unit weight	Unit weight	ASTM C138/AASHTO T 121	<ul style="list-style-type: none"> Indicates yield of the mixture and provides a rough estimate of air content Establish basis for QC monitoring
Strength development	Compressive or flexural strength	ASTM C39/AASHTO T 22 and/or ASTM C78/AASHTO T 97 at 1, 3, 7, 28, and 56 days	<ul style="list-style-type: none"> Calibrate strength gain for early age QC Calibrate flexural with compressive strengths Adjust w/cm ratio to ensure sufficient strength
	Maturity	ASTM C1074	<ul style="list-style-type: none"> Calibrate the mixture so maturity can be used in the field to determine opening times
Transport	Resistivity/F-factor	Soak/store samples in salt solution	<ul style="list-style-type: none"> Determine development of F-factor over time Adjust w/cm ratio to achieve required performance
	Sorption	ASTM C1585	<ul style="list-style-type: none"> Determine time to critical saturation
	W/cm ratio	Microwave	<ul style="list-style-type: none"> Calibrate microwave test with batch data
Other	Hydration	Semi-adiabatic calorimetry	<ul style="list-style-type: none"> Determine hydration rates of mixture Set a baseline for QC Assess risk of incompatibilities if supplementary cementitious materials (SCMs)/admixtures/temperatures change Adjust SCM source, WRA type, or operating temperature if incompatibility is observed
	Oxychloride risk	LT-DSC on paste	<ul style="list-style-type: none"> Assess risk of joint deterioration if salts are used Increase SCM dose if risk is excessive
	Coefficient of thermal expansion (CTE)	AASHTO T 336	<ul style="list-style-type: none"> Confirm that assumptions used in structural design are appropriate
	Mortar content	Vibrate a container (air pot) for 5 minutes and measure depth of mortar at the top surface	<ul style="list-style-type: none"> This provides information on the coarse aggregate content—maximum is ~¼ in.

Table 9-4. Field setup tests

Concrete property	Test description	Test method	Comments
Workability	Aggregate gradation	ASTM C136/AASHTO T 27 ASTM C566/AASHTO T 255	• Use the individual gradations and proportions to calculate the combined gradation
	Combined gradation	Tarantula curve	• Adjust combined gradation to achieve optimum workability
	Slump	ASTM C143/AASHTO T 119	• Determine WRA dosage range
Air-void system	SAM	AASHTO TP 118	• Determine AEA dosage range
Unit weight	Unit weight	ASTM C138/AASHTO T 121	• Confirm basis for QC monitoring
Strength development	Compressive or flexural strength	ASTM C39/AASHTO T 22 and/ or ASTM C78/AASHTO T 97	• Confirm strength development
Transport	Resistivity/F-factor	Soak samples in salt solution	• Confirm development of F-factor over time
Other	Hydration	Semi-adiabatic calorimetry	• Confirm baseline for QC

Table 9-5. Mixture QC tests

Concrete property	Test description	Test method	Comments
Workability	Aggregate gradation	ASTM C136/AASHTO T 27 ASTM C566/AASHTO T 255	• Use the individual gradations and proportions to calculate the combined gradation
	Combined gradation	Tarantula curve	• Monitor uniformity
	Aggregate moisture content	ASTM C29	• Affects w/cm ratio and workability
	Slump	ASTM C143/AASHTO T 119	• Indicates uniformity batch to batch
Air-void system	SAM	AASHTO TP 118	• Indicates uniformity batch to batch
Unit weight	Unit weight	ASTM C138/AASHTO T 121	• Indicates uniformity batch to batch
Strength development	Compressive or flexural strength	ASTM C39/AASHTO T 22 and/ or ASTM C78/AASHTO T 97	• Indicates uniformity batch to batch
	Maturity	ASTM C1074	• Opening times
Transport	Resistivity/F-factor	Soak samples in salt solution	• Monitor over time • Indicates uniformity batch to batch
Other	Hydration	Semi-adiabatic calorimetry	• Indicates uniformity batch to batch

A challenge with laboratory-based testing is that a mixture will perform differently when produced in a small laboratory mixer compared to a full-sized batch plant. It is therefore recommended that when the plant is being set up, a more limited suite of tests be conducted to make adjustments and to confirm that the mixture is performing satisfactorily (Table 9-4).

Once construction is underway, the contractor should be continually monitoring the mixture to adjust for variations in the delivered materials and weather. These QC tests should provide assurance that the concrete being delivered is on track to meet specification requirements and will often be conducted at early ages. If problems or negative trends are observed, adjustments should be made early to prevent rejection. The recommended work for a QC evaluation of the mixture is shown in Table 9-5.

The final tests are those conducted by the agency to assure that the concrete they are paying for has been delivered and placed. These tests are conducted at specified intervals and at fixed ages (Table 9-6).

Table 9-6. Mixture acceptance tests

Concrete property	Test description	Test method
Air-void system	SAM	AASHTO TP 118
Strength	Compressive or flexural strength	ASTM C39/AASHTO T 22 and/or ASTM C78/AASHTO T 97
Transport	Resistivity/F-factor	Soak samples in salt solution
Other	W/cm ratio	Microwave

Batching

Batching is a critical part of concrete QC. To ensure a uniform mix from batch to batch, the materials must be uniform and the handling systems consistent. The batch plant must be continuously monitored and regularly calibrated (see [Stockpile Management](#) and [Batching](#) under [Concrete Production in Chapter 8](#)).

Issues to monitor during batching include the air-void system, aggregate moisture, and w/cm ratio.

Air Content

Routinely achieving the target air content and air-void system is one of the most challenging aspects of controlling concrete mixtures. Project specifications often allow the air content of the concrete to be within -1 to +2 percentage points of the target value.

The factors that affect the air-void system in concrete include the following:

- **Ingredients:** Any change in source or amount of any of the mix ingredients may change the air-void system
- **Temperature:** Increasing concrete temperature tends to reduce air content for a given dosage of air-entraining admixture (AEA)
- **Mixing time:** Air content tends to increase with continuing mixing time up to a limit, at which point it will decrease
- **Batching sequence:** Changing the batching sequence may change the air content of a concrete
- **Slump:** More air will be entrained in a high-slump mixture than in a similar low-slump mixture; however, water should not be added to the truck in order to raise the air content of a given batch
- **Admixture interactions:** Some water-reducing admixtures will affect air
- **Haul time:** Increasing haul time may reduce air content
- **Vibration:** Excessive vibration may remove air from the concrete

Tests should be conducted at the plant, at the paver, and behind the paver. Tests should be conducted in front of the paver every hour, or every 300 lane-ft of paving, or every 70 yd³ of concrete. Tests should be conducted behind the paver periodically to observe the amount of air loss during handling. If it is more than about 2 percent, control of the final product will be difficult.

Tests are conducted using the super air meter (SAM) (AASHTO TP 118) and pressure air meter (ASTM C231/AASHTO T 152). Other methods may be considered if necessary—volumetric air meter (ASTM C173/AASHTO T 196) or gravimetric (ASTM C138/AASHTO T 121) (see [Air-Void System under Factors Affecting Resistance to Freezing and Thawing in Chapter 6](#)).

Aggregate Moisture

Aggregates' moisture content can influence concrete's workability, strength, and durability. All normal-weight aggregates possess some porosity accessible to water. Depending on its moisture condition, aggregate can either take up or add to the mix water. It is therefore important to know the aggregate's moisture condition during batching and to adjust the mix water accordingly.

Most difficulties with surface moisture stem from fine aggregate. Coarse aggregate will commonly have absorption levels of 0.2 to 4 percent and free water content from 0.5 to 2 percent. Fine aggregate will have absorption levels of 0.2 to 2 percent and free water content from 2 to 6 percent (Kosmatka and Wilson 2016).

Coarse aggregate moisture can be assessed using ASTM C127/AASHTO T 85; fine aggregate can be assessed using ASTM C70 or ASTM C128/AASHTO T 84. Total moisture content, fine or coarse, can be determined using ASTM C566-97/ASHTO T 255. It is common to conduct moisture tests on representative examples of stockpiled aggregates once or twice a day (Kosmatka and Wilson 2016).

Good stockpile management will help maintain uniform moisture content (Landgren 1994). Because aggregate surface moisture, especially of the fines, is so important to proper mix control, surface moisture is often monitored with moisture meters (electric or microwave absorption) on the batching equipment (Landgren 1994). Properly placed and maintained meters can provide accurate, continuous measurement of aggregate surface moisture, as long as other plant operations are conducted properly.

Water/Cementitious Materials Ratio

The w/cm ratio of a mixture must be carefully controlled to maintain concrete quality. The w/cm ratio is difficult to measure directly, so it is important to monitor and control the batching process.

The microwave test method (AASHTO T 318) has been used to determine the water content of fresh concrete. By coupling the water content (less water absorbed in the aggregates) with batch weights of the dry ingredients, the w/cm ratio is computed.

Batching Tolerances

Aggregates and cementitious materials are most commonly batched by weight. Liquid constituents, such as mix water and liquid admixtures, can be batched by volume.

ASTM C94, *Specifications for Ready-Mixed Concrete*, stipulates the recommended tolerances for batching concrete tolerances (Table 9-7).

Monitoring Construction Activities

Key Points

- During construction, the concrete temperature, air-void system, amount of vibration, and dowel bar locations must be monitored and adjusted as necessary.
- Concrete temperature should be monitored/controlled to assure workability and minimize risk of cracking.
- Routinely achieving the target air content and air-void system is one of the most challenging aspects of controlling concrete mixtures because so many variables affect the air system. Tests should be conducted at the batch plant and, if practical, behind the paver.
- Vibrator monitors help equipment operators ensure that the proper amount of vibration is applied to produce homogeneous, dense concrete without adversely affecting the entrained air.
- Dowel bars must be aligned horizontally and vertically and positioned at about the middle of the slab depth.

QC and acceptance tests are also recommended during the construction phase to ensure that the final pavement will perform as intended (Tables 9-8 and 9-9).

Table 9-7. Recommended batch tolerances for ready-mixed concrete* (ASTM C94)

Constituent	Individual,** %	Cumulative,*** %
Cementitious materials	±1	±1
Water	±1	±3
Aggregates	±2	±1
Admixtures	±3	N.R.****

* Batch weights should be greater than 30 percent of scale capacity.

** Individual refers to separate weighing of each constituent.

*** Cumulative refers to cumulative weighing of cement and pozzolan, of fine and coarse aggregate, or water from all sources (including wash water).

**** Not recommended.

Table 9-8. Construction QC tests

Property	Test method	Comments
Vibration monitoring	On board monitors	<ul style="list-style-type: none"> • Monitor that all vibrators are operating • Ensure vibrator speed is appropriate for paver speed
Thickness	Probe behind paver	—
Smoothness	Real-time smoothness monitoring	—
Dowel alignment	MIT-DOWEL-SCAN	—

Table 9-9. Construction acceptance tests

Property	Test method
Vibration monitoring	On board monitors
Thickness	MIT-SCAN-T3
Smoothness	Hardened smoothness—Inertial profiler
Dowel alignment	MIT-DOWEL-SCAN

The final tests are those conducted by the agency to assure themselves that the concrete they are paying for has been delivered and placed. These tests are conducted at specified intervals and at fixed ages.

Temperature

The temperature of concrete as placed and shortly thereafter can have a large impact on both the fresh and hardened properties ([see Temperature Effects in Chapter 6](#)).

Problems associated with high concrete temperatures include the following:

- Increased water demand to maintain workability
- Decreased setting time
- Increased danger of plastic and early-age shrinkage cracking
- Difficulty in achieving proper air-void properties
- Lower ultimate strength

Problems associated with low concrete temperatures include the following:

- Reduced rate of hydration, thus increasing the risk of plastic shrinkage cracking and changing the saw-cutting window
- Reduced early strength
- Freezing of the concrete before it sets (with extremely cold temperatures)

Concrete temperature should be monitored/controlled to assure workability and minimize risk of cracking ([see Field Adjustments in Chapter 8](#)).

ASTM C1064/AASHTO T 309 provide the standard for determining the temperature of fresh concrete. The temperature measuring device used must be accurate to $\pm 1.0^{\circ}\text{F}$ and must remain in the concrete for at least 2 minutes or until the temperature stabilizes.

Vibration Monitoring

Vibration and consolidation can have a significant impact on the durability of concrete pavement. Proper vibration produces a pavement that is homogeneous and dense without adversely impacting the entrained air in the mix.

Prior to 1996, vibrator monitors were not available commercially (Steffes and Tymkowicz 2002). Today's vibrator monitors give the paver operator a convenient way to preprogram, operate, and monitor vibrator operation. Vibrator monitors also enable the inspection personnel to view in real time the frequency of all vibrators during the paving operation. Data can also be downloaded to a computer for later analysis.

Vibrator frequency should be adjusted for the following:

- Workability
- Response to vibration
- Resistance to segregation
- Thickness of pavement
- Speed of paver
- Stiffness of subbase

Dowel Bar Tolerances

Factors that affect dowel performance are diameter, alignment, and embedment length. Dowels must allow horizontal movement between adjacent slabs and, therefore, should be lubricated sufficiently to prevent bonding (Snyder 2011). Diameter and embedment length requirements are discussed in [Chapter 4](#).

Dowel placement tolerances usually include the five ways that dowel bars can be out of position (two with alignment and three with location):

- Alignment
 - Horizontal skew (Is the dowel parallel to the centerline?)
 - Vertical tilt (Is the dowel parallel to the top surface of the pavement?)
- Location
 - Longitudinal translation or "side shift" (Is the joint centered on the dowel?/Is there adequate embedment length?)
 - Horizontal or lateral translation (Is the dowel the correct distance from the pavement edge or adjacent dowels?)
 - Vertical translation or "depth deviation" (Is the dowel positioned the correct distance from the pavement surface or bottom [typically near mid-depth]?)

Numerous studies have been conducted on the topic of dowel bar alignment, many of them brought about by the advent of more rapid and accurate dowel bar position-measuring devices (e.g., ground-penetrating radar [GPR], magnetic imaging tomography [MIT], and ultrasonic tomography devices). Recent studies have concluded that misalignment and/or mislocation must be present at higher levels than previously thought to adversely impact pavement performance (Yu 2005, Khazanovich et al. 2009).

The American Concrete Pavement Association (ACPA) has produced a guide specification for dowel positioning (ACPA 2019). This document provides guidance on the following:

- The use of dowel location information for paving process validation and production QC
- Recommended alignment and location tolerances to ensure good construction quality (through acceptance tolerance values) and to prevent premature joint failures and loss of pavement serviceability (rejection tolerance values)

Positioning values that exceed the acceptance thresholds but are less than the rejection thresholds require process corrections but not dowel or joint corrections. This dual-threshold concept is illustrated in Figure 9-2.

Acceptance and rejection thresholds are provided for each positioning measure. The following sections summarize the current state of the practice and recommended guidelines for dowel alignment and position.

Alignment (Tilt and Skew)

Dowels must be aligned “such that they impose no intolerable restraint on joint opening/closing” (ACPA 2019). Alignment requirements have been established for individual dowels as well as groups of dowels across entire joints.

Early Federal Highway Administration (FHWA) recommended limits on dowel rotation (horizontal skew or vertical rotation) of ¼ in. per ft of dowel bar length or 2 percent (FHWA 1990) have been found to be overly restrictive for ensuring good field performance (Yu 2005, Khazanovich et al. 2009). The ACPA (2018) recommends composite misalignment acceptance and rejection values of up to ¾ in. and 2 in., respectively, per 18 in. dowel. Composite misalignment is defined as follows:

$$\text{Composite Misalignment (CM)} = \sqrt{(\text{Horizontal Skew})^2 + (\text{Vertical Tilt})^2} \quad (9.1)$$

Poor dowel alignment does not necessarily result in the development of slab cracking and spalling. An individual misaligned dowel may result in no measurable impact, loss of effectiveness of the dowel, or minor slab cracking/spalling, depending on the degree of misalignment, the dowel position in the joint, and other factors. However, the presence of several misaligned dowels in a single joint may significantly restrain joint function. Yu (2005) developed the concept of a “joint score” to assess the potential impact of all misaligned dowels in a joint-on-joint restraint. The ACPA (2018) refines this concept to account for joints of varying width.

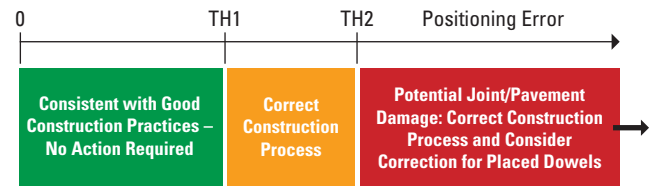

TH1 = Alignment or location threshold representing upper limit of good construction practices

TH2 = Alignment or location threshold representing lower limit for risk of damage or performance issues

Mark B. Snyder, used with permission

Figure 9-2. Dual-threshold dowel positioning specification concept

The number of consecutive joints that must “lock” to produce distress depends on many factors, including climate conditions, pavement structural design, concrete properties, restraint provided by the slab-subbase interface, and others (ACPA 2005). The ACPA (2018) provides guidance on determining the maximum effective panel length (MEPL) for different climate and pavement support conditions.

Embedment Length (Longitudinal Translation)

Khazanovich et al. (2009) found that dowels with at least 4 in. of embedment on either side of the joint provided adequate load capacity and similar behavior to dowels with greater depths of embedment. In new construction, total dowel length is always longer than twice the embedment length (typically 15 to 18 in.) to ensure that minimum embedment requirements are met despite potential construction variances in dowel placement and saw-cut location. Shorter dowels are increasingly used in repairs and retrofit applications in which embedment length is controlled directly.

The ACPA (2018) recommends acceptance of individual dowels with longitudinal translation or “side shift” of 2 in. or less and rejection of side shift that results in less than 4 in. of dowel embedment on either side of the joint.

Horizontal Translation

Significant lateral misplacements of dowels, resulting in unplanned nonuniform dowel spacing, are rare and have not been shown to result in pavement performance problems (ACPA 2019). Dowel alignment and positioning specifications generally ignore this type of positioning issue. This stands to reason because in most cases fewer or farther-spaced bars than the standard 12 in. center-to-center spacing can be shown to provide as effective a load transfer using finite element analysis programs or applications such as the ACPA’s DowelCAD.

Dowel Depth (Vertical Translation)

Vertical dowel position is usually not considered critical to dowel or joint performance provided there is enough concrete cover above and below the dowel to provide adequate shear capacity for the transferred load (usually at least 3 in. of concrete). Dowels are often placed significantly above or below mid-depth either by design (e.g., in the precast paving industry where dowel position is established to provide adequate cover while minimizing slot depth) or as an artifact of construction (e.g., in areas of super-elevation where dowels in basket assemblies may be well below mid-depth and implanted dowels may be well above mid-depth). Therefore, vertical position is generally monitored as an indication of construction QC (acceptance limits) and to ensure adequate concrete cover above and below the dowel. In addition, consideration must be given to ensure that joint saw cuts do not impact dowels.

The ACPA (2018) recommends an acceptable vertical placement tolerance (deviation from planned vertical position) of ½ in. and rejection when the clear distance between bottom of saw cut and top of dowel is less than ¼ in. or when the total concrete cover is not adequate for shear load transfer (typically about 3 in.).

Thickness

The thickness of a concrete pavement can have a significant impact on potential longevity because stresses increase rapidly as thickness decreases. A reduction in concrete slab thickness by an inch may result in as much as a 50 percent reduction in the service life of the pavement.

Many highway agencies seek to ensure that the pavement thickness is no less than 0.5 in. thinner than specified. Pavement thickness, therefore, should be monitored during construction.

The traditional approach has been to extract cores, but this approach is destructive and can only be undertaken after the concrete has reached sufficient strength. Some nondestructive tests are available for measuring concrete pavement thickness, such as the ASTM C1383 *Standard Test Method for Measuring the P-Wave Speed and the Thickness of Concrete Plates Using the Impact-Echo Method* and ASTM D4748 *Standard Test Method for Determining the Thickness of Bound Pavement Layers Using Short-Pulse Radar*. These techniques are not considered to be as accurate or reliable as the coring approach.

The MIT-SCAN-T3 is a handheld device that is able to measure the thickness of pavement layers based on MIT.

Reflectors have to be randomly placed on the base before the concrete is paved. The accuracy of the T3 is reported to be within 0.5 percent of the measured thickness plus 0.04 in., which translates to an accuracy of 0.1 in. for a concrete pavement 12.9 in. thick.

Real-Time Smoothness

Road users judge the quality of a road primarily based on its ride quality. With increasing emphasis and attention being paid to smoothness by agencies as part of their asset management programs, it is desirable to construct concrete pavements that are smooth at the outset.

The use of real-time smoothness (RTS) equipment can assist the contractor in improving the initial smoothness of concrete pavements. There are currently two commercial systems available for measuring smoothness in real time. One is based on laser sensors; whereas, the other uses sonic sensors. Both are configured with sensors mounted to the back of the paver to measure the pavement profile and display it on a screen in real time.

Both systems use a combination of height, slope, and distance data that are continuously collected and converted to a real-time profile and smoothness statistic (International Roughness Index (IRI), Profile Index (PI), must grinds, and localized roughness). Distance data are collected using a calibrated wheel mounted to a paver track or an internal encoder.

RTS systems can provide instant feedback that allows contractors to adjust their processes to improve the initial smoothness characteristics (overall smoothness and localized roughness) of the new concrete pavement.

Test Methods

Tests are used to identify whether a given mixture or batch is likely to survive the environment for the intended life, and as such whether it should be accepted for payment. Following are short summary sheets that describe the tests listed in [Tables 9-3 to 9-6](#). These lists are not necessarily complete, and changes may be required for a given situation.

The descriptions that follow are not intended to substitute for formal methods described in various specifications and methods published by organizations like AASHTO and ASTM International. Sufficient information is given here to help readers understand how and why a test should be conducted. Readers should refer to the relevant full-method statement before attempting to conduct any test.

As noted above, more tests are recommended early in the process of designing a mixture; whereas, relatively few are suggested for acceptance purposes.

Combined Grading

Purpose—Why Do This Test?

Aggregate grading may influence the water requirement, workability, and paste contents. These in turn may impact the risk of segregation, bleeding, and increased shrinkage of concrete paving mixes.

It is desirable to blend different aggregate sizes to obtain a good performing mixture that is placeable without excessive vibration and has robust workability properties.

Principle—What Is the Theory?

The sieve analysis (amount of material retained or passing a series of sieves with different-sized openings) is compared to an optimized system (Tarantula curve) using a graphical model. Having combined grading within the Tarantula curve reduces the risk of grading-related problems in the mixture.

Test Procedure—How Is the Test Run?

1. Sieve analyses are conducted in accordance with ASTM C136 for the coarse and fine fractions.
2. The percent retained for the combined aggregates on each individual sieve is plotted on the Tarantula curve.

Output—How Do I Interpret the Results?

The Tarantula curve consists of three parts (Figure 7-2)—the percent retained by sieve, the fine sand (sum of the percent retained on the #200, #100, #50, and #30 sieves), and the coarse sand (sum of the percent retained on the #30, #16, and #8 sieves). This procedure was developed with the Box test, which provides qualitative feedback regarding a concrete mixture's response to vibration.

The percent retained on each sieve should plot within the limits shown. The coarse sand should be greater than 15 percent retained and the fine sand should be between 24 percent and 34 percent for best results with slipform placement.

Construction Issues—What Should I Look For?

Modest variations in grading are to be expected from batch to batch and generally do not have a significant impact on performance. Extreme variations in grading and workability should be addressed as they occur.

Workability concerns attributable to aggregate grading can be identified by observing the following conditions:

- Stockpile segregation and/or inconsistent stockpiling methods
- Inconsistent slump (mix water is static while grading changes)
- Excessive bleeding
- Variation in vibrator frequencies
- Edge slump
- Poor consolidation observed in cores
- Segregation observed in cores

VKelly (Response to Vibration)

Purpose—Why Do This Test?

Slipform paving mixtures need to be workable in the field without requiring excessive vibration, which can lead to segregation, excessive shrinkage, cracking, and other undesirable effects. This procedure can be used to compare the workability of potential mixtures in the laboratory (AASHTO TP 129).

Principle—What Is the Theory?

A concrete mixture's response to vibration is a good indicator of whether it will be placeable in the field. The VKelly test is an adaption of the existing Kelly ball test with vibration added. This is especially useful for quantifying and comparing stiff (low-slump) mixtures designed for slipform placement. The VKelly test provides feedback about the static and dynamic behavior of a mixture.

Test Procedure—How Is the Test Run?

1. Materials representative of the proposed mixture are mixed in the laboratory and placed in a plastic tub, and the static Kelly ball test is performed followed by the VKelly testing.
2. Depth of penetration is measured for both.
3. The static penetration and a VKelly index, which is a function of penetration over time, are calculated and reported.

Test Apparatus



Figure 9-3. VKelly apparatus

- Rubber/Plastic tub—6.5 gal capacity, 17 in. diameter, and 8 in. depth
- VKelly frame
- Wyco square vibrator head
- Steel Kelly ball

Summary of Test Method

Static test:

1. Fill the tub with fresh concrete
2. Lower the ball until it just touches the surface of the concrete
3. Record the initial reading to the nearest 0.10 in.
4. Let the ball sink under its own weight and record the depth to the nearest 0.10 in.

Dynamic test:

1. Remix the concrete for approximately 30 seconds after performing the static test
2. Lower the ball until it just touches the surface of the concrete
3. Simultaneously turn on the vibrator to 8,000 vpm and start the timer
4. Record depth readings every 6 seconds for up to 36 seconds

5. After completion, remove the concrete and remix for approximately 30 seconds
6. Repeat the VKelly test to obtain two sets of depth and time readings
7. Report the average of these three as the test result

Output—How Do I Interpret the Results?

The static Kelly ball test results are reported as penetration to the nearest 0.10 in. Average of two results is multiplied by 2 to obtain the slump equivalent.

VKelly test results are plotted on an x-y graph (see [Figure 6-2](#)) and a linear regression analysis is performed on the dataset. The VKelly index is the slope of the linear regression equation (0.41 in [Figure 6-2](#)).

Construction Issues—What Should I Look For?

The VKelly test provides an indication of a mixture's workability and response to vibration. Therefore, the following may be indicators during construction that the mixture is not optimized for slipform placement:

- Surface voids requiring considerable hand finishing or the addition of water to the surface to close the voids
- Stockpile segregation and/or inconsistent stockpiling methods
- Inconsistent workability (mix water is static while grading changes)
- Edge slump
- Poor consolidation observed in cores
- Segregation observed in cores

Box Test (Response to Vibration)

Purpose—Why Do This Test?

Slipform paving mixtures need to be workable in the field without requiring excessive vibration, which can lead to segregation, excessive shrinkage, cracking, and other undesirable effects. This procedure can be used to compare the workability of potential mixtures in the lab.

Principle—What Is the Theory?

A concrete mixture's response to vibration is a good indicator of whether it will be placeable in the field. The Box test is a laboratory procedure that provides feedback on surface voids and edge stability for a given mixture. Samples can be remixed with the addition of water-reducing admixture until they conform to the Box test standard. Mixtures requiring little or no additional water-reducing admixture to meet the Box test standard are preferable over mixtures requiring higher dosages of admixture.

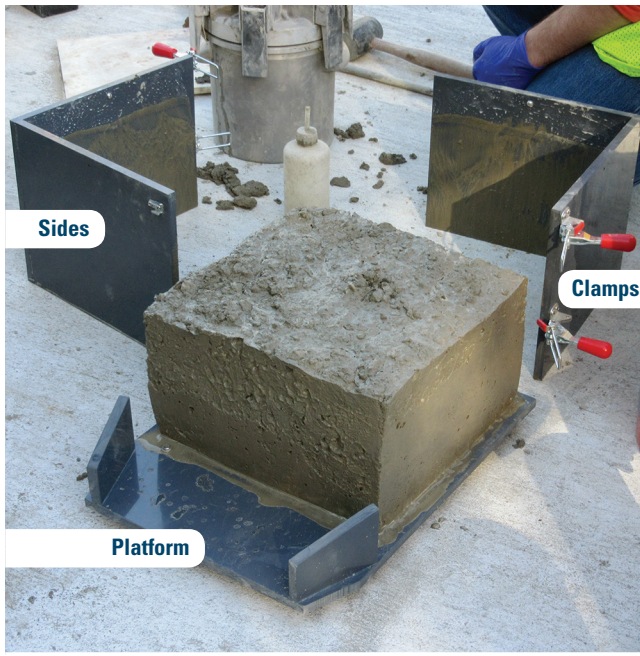

Step 1
Gather the different components of the Box test.



Step 2
Construct box and place clamps tightly around box. Hand scoop mixture into box until the concrete height is 9.5 in.



Step 3
Insert vibrator downward for 3 seconds and upward for 3 seconds. Remove vibrator.



Step 4
After removing the clamps and the forms, inspect the sides for surface voids and edge slumping.

Figure 9-4. Box test procedure

Test Procedure—How Is the Test Run?

Materials representative of the proposed mixture are mixed in the laboratory, placed into the Box test mold, vibrated, and visually inspected for surface voids and conformance to a standard rating system.

Test Apparatus

- Laboratory mixer
- Hand scoop
- 12 × 12 in. plywood box with removable sides

- Square head vibrator set to 12,500 vpm
- Standard rating reference

Summary of Test Method (Figure 9-4)

1. Assemble the box
2. Mix the proposed mixture proportions
3. Hand scoop the mixture into the box to a height of 9 ½ in.

4. Insert the vibrator in the center of the box for 3 seconds to the bottom of the concrete sample and then lift the vibrator out of the sample over a 3-second interval (total time of 6 seconds)
5. Immediately disassemble the box
6. Inspect the sides of the concrete sample for surface voids and edge deformation (slumping and/or sloughing)
7. If the surface void score is greater than 2, remix the sample for 3 minutes with the addition of 2 oz/cwt of water-reducing admixture
8. Repeat as necessary until the surface void score is less than or equal to 2 (<http://www.optimizedgraded.com/the-box-test.html>)

Output—How Do I Interpret the Results?

After removal of the box edges, surface voids on the edges of the concrete sample are compared to a standard rating system (Figure 9-5). A score greater than 2 indicates that the mixture may not be appropriate for best results using a slipform placement.

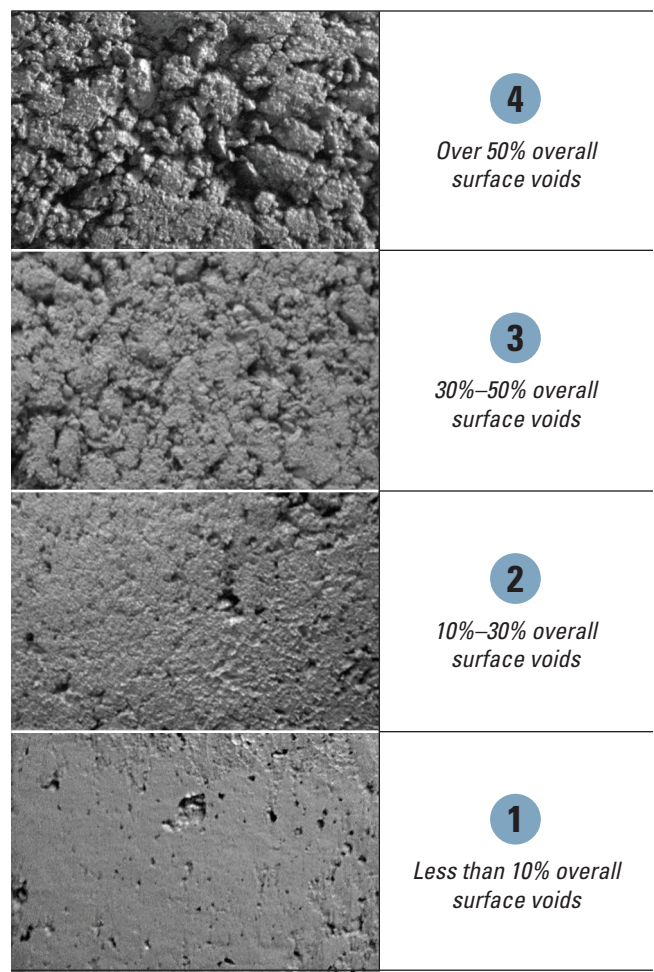

Figure 9-5. Rating standards for Box test

Construction Issues—What Should I Look For?

The Box test is an empirical evaluation of a mixture’s combined grading and response to vibration. Therefore, the following may be indicators during construction that the combined gradation is not optimized for slipform placement.

- Surface voids requiring considerable hand finishing or the addition of water to the surface to close the voids
- Stockpile segregation and/or inconsistent stockpiling methods
- Inconsistent workability (mix water is static while grading changes)
- Edge slump
- Poor consolidation observed in cores
- Segregation observed in cores

Foam Drainage

Purpose—Why Do This Test?

This test provides an indication of the likely stability of the air-void system in fresh concrete as it is affected by the interactions of the chemical admixtures and the cementitious materials.

Principle—What Is the Theory?

A foam is made using the paste materials in a blender. The rate at which the foam decomposes is a measure of the stability of the air-void system, where the faster the decomposition, the more likely it is that the air-void system will change during handling.

Test Procedure—How Is the Test Run?

1. Foam is generated using fixed proportions of cement, SCMs, WRA, AEA, and water, and a 1 L graduated cylinder is filled with the foam.
2. The volume of fluid that collects at the bottom of the cylinder is recorded at regular intervals for an hour.

Test Apparatus

- Blender
- Stopwatch
- 1 L measuring cylinder

Output—How Do I Interpret the Results?

The volume of fluid is plotted against time (on an inverted scale). The ultimate volume is extrapolated from the plot and reported. The higher the number, the higher the probability that air may be lost during handling.

If this occurs, it is recommended that the combination of AEA and WRA be reconsidered.

Air Content (Plastic Concrete, Pressure Method)

Purpose—Why Do This Test?

Entrained air is essential to the long-term durability of concrete pavements that are subject to freezing and thawing. Air content is a commonly specified parameter in paving specifications. It is usually measured at the truck using a pressure meter (normally a Type B meter).

Principle—What Is the Theory?

The fresh concrete is fully consolidated in an airtight container. Pressure from a fixed-volume cell is applied to the sample in the container. Air in the sample is compressed, and the reduction in pressure in the cell is directly related to the volume of air in the sample. The air content of the sample is thus read directly from the gauge of a properly calibrated meter and then adjusted for the appropriate aggregate correction factor when necessary.

Summary of Test Procedure—How Is the Test Run?

The test is described in ASTM C231/231M. A sample of fresh concrete is fully consolidated in the air meter and struck off level-full. A known volume of air at a known pressure is applied to the sample in an airtight container. The air content of the concrete is read from the gauge on the pressure meter apparatus.

Test Apparatus

- Measuring bowl and airtight cover (Type B meter) for holding the sample and measuring the air content
- Tamping rod/vibrator and mallet for consolidating the sample

Test Method

1. Consolidate the concrete in the measuring bowl using a tamping rod or vibrator and mallet
2. Strike off the concrete in the measuring bowl so that it is level-full with the top rim
3. Clean the edge and rim of the measuring bowl and clamp the cover on to form an airtight seal
4. Pump air into the air chamber until the gauge needle is stabilized on the initial pressure line
5. Open the valve between the air chamber and the measuring bowl
6. Tap the measuring bowl with the mallet to ensure that pressure is equalized

7. Tap the gauge lightly if necessary to stabilize the needle indicator
8. Record the percentage of air content indicated on the gauge

Output—How Do I Interpret the Results?

Air content of the fresh concrete mix is read directly from the gauge of a calibrated Type B pressure meter.

This is a measure of the percentage of total air content in a concrete mix. Both entrained air and entrapped air are measured.

The results are compared to the specified limits.

Construction Issues—What Should I Look For?

Air content should be monitored regularly during paving (minimum one test every two hours).

Generally, air contents greater than 5.0 percent (depending on exposure and aggregate size) from samples taken behind the paver provide adequate protection from freeze/thaw conditions. The use of a SAM is recommended to be sure that proper bubble spacing and bubble size are present.

High air contents are less worrisome than low air contents, unless the strength is reduced to critical levels due to the high air content.

Air content can be affected by many factors, ranging from cement and admixture chemistry to mixing time and aggregate grading.

Super Air Meter

Purpose—Why Do This Test?

Freeze-thaw resistance of concrete is primarily controlled by the spacing factor of the air-void system. The SAM number has been correlated to the spacing factor and durability factor (DF) in hardened concrete, rather than waiting for microscopical analysis of hardened concrete. A modified pressure air content test is performed on a sample of concrete and a SAM number is reported. A SAM number of 0.20 lb/in² or less correlates well to a spacing factor of 0.008 in. or less.

Principle—What Is the Theory?

Using a SAM at multiple and higher pressures than a typical air content provides an indication of the quality of the air-void system.

Summary of Test Procedure—How Is the Test Run?

Just like the traditional AASHTO T 152 pressure air method, the SAM subjects the concrete sample to an initial pressure of 14.5 lb/in². Then the SAM subjects the sample to additional pressures of 30 lb/in² and 45 lb/in². These additional pressurizations provide an indication of the quality of the air-void system.

Test Apparatus

- SAM (measuring bowl and airtight cover, Figure 9-6) for holding the sample and measuring the air content (the SAM has additional clamps due to the higher test pressures and a digital gauge)
- Tamping rod/vibrator and mallet for consolidating the sample

Test Method

1. Consolidate the concrete in the SAM using a tamping rod or vibrator and mallet
2. Strike off the concrete in the SAM so that it is level-full with the top rim
3. Clean the edge and rim of the SAM and clamp the cover on to form an airtight seal
4. Pump air into the air chamber until the gauge is stabilized at the initial pressure (14.5 lb/in²)
5. Open the valve between the air chamber and the measuring bowl



Figure 9-6. Super air meter

6. Tap the measuring bowl with the mallet to ensure that pressure is equalized
7. Record the percentage of air content indicated on the gauge
8. Re-pressurize the sample to 30 lb/in² and release
9. Re-pressurize the sample to 45 lb/in² and release
10. Record the SAM number

Output—How Do I Interpret the Results?

Based on Figure 9-7, SAM numbers of less than 0.20 lb/in² indicate an acceptable air-void system.

Construction Issues—What Should I Look For?

The SAM is a convenient way to monitor the spacing factor in fresh concrete. Changes in the results will indicate changes in the concrete mixture, which should then be investigated.

The SAM number should be monitored regularly during paving (minimum one test every two hours).

The SAM may also be used to assess changes in the air-void system due to transporting and handling through the paver.

Air Content (Hardened Concrete)

Purpose—Why Do This Test?

Another method of determining the quality of an air-void system in concrete is microscopic analysis of hardened concrete. This method provides information on the total air content, as well as the spacing factor and other parameters.

Principle—What Is the Theory?

The air-void structure of concrete can be measured and characterized by examining a section of a core with a microscope. The linear traverse method consists of measuring the air voids as a polished concrete sample travels under a microscope in regularly spaced lines. The length of travel across air voids is compared to the length of travel across paste and aggregate, and the data are used to calculate the air content, spacing factor, and specific surface of the air voids in the concrete sample.

Test Procedure—How Is the Test Run?

The method is described in ASTM C457. A core from the slab is sectioned and polished. The apparatus is used to move a core sample under a microscope (or vice versa) in straight lines. The total length traversed and the length traversed across air voids are recorded.

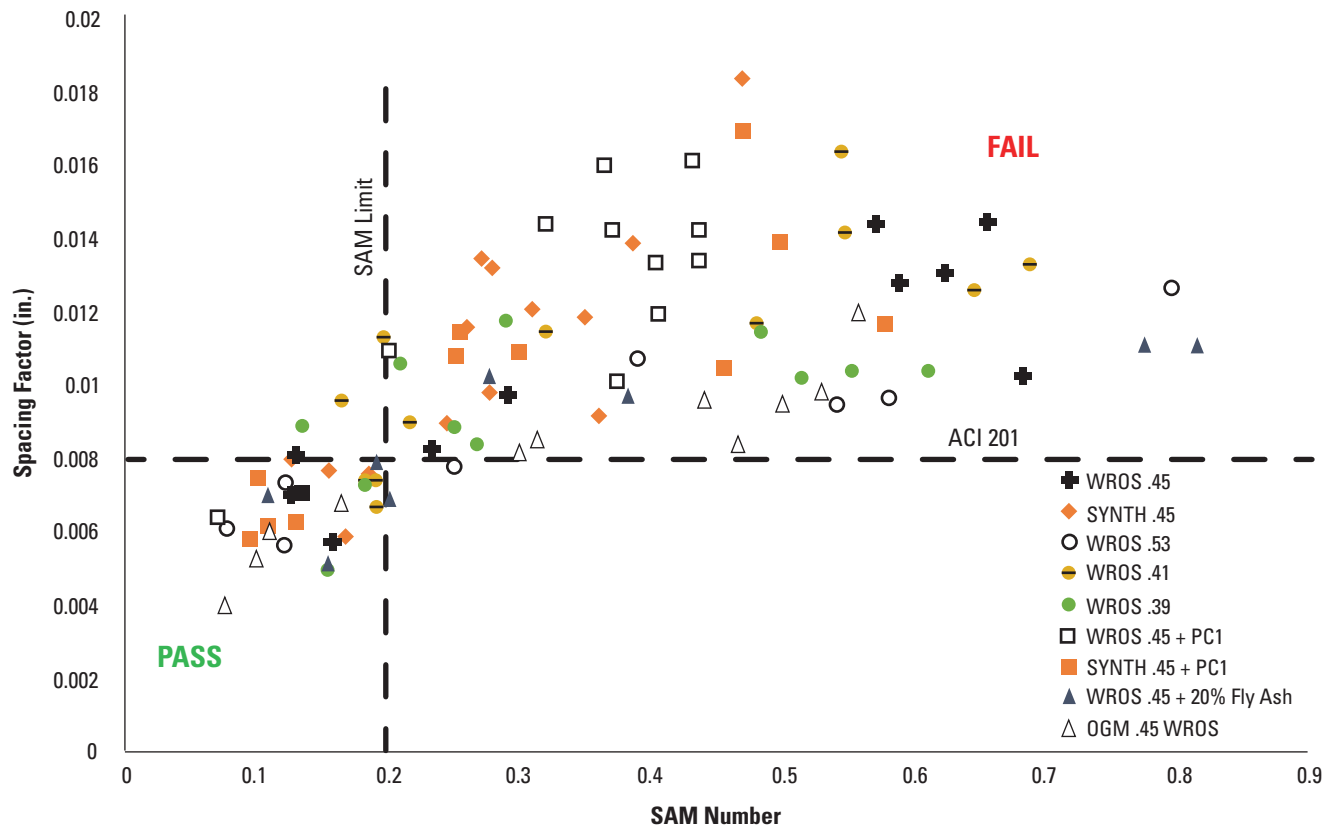

Recreated from Welchel 2014

Figure 9-7. Plot of SAM number versus spacing factor

Test Apparatus

- Saw for cutting a section of a core
- Polishing tools for grinding, lapping, and preparing the core section
- Hardware and software for measuring air voids in the core section

Output—How Do I Interpret the Results?

The software produces a tabular report showing air content, spacing factor, and specific surface area of the air voids. A digital image of the core section can also be viewed or printed.

The air content is expressed as a percent of volume of the concrete sample.

Spacing factor is the average distance from any point to the nearest air void or the maximum length measured from the cement paste to the edge of an air void.

Specific surface area is the surface area of the air voids divided by the air voids' volume.

Construction Issues—What Should I Look For?

Spacing factors should be less than 0.008 in.

Air-void spacing can be impacted by many factors, ranging from cement and admixture chemistry to mixing time to aggregate grading.

Unit Weight

Purpose—Why Do This Test?

The unit weight of fresh concrete is a general indicator that the concrete has been batched in the correct proportions. It is an excellent indicator of uniformity of a mixture from batch to batch.

Principle—What Is the Theory?

A concrete mix design is composed of several ingredients: portland cement, SCMs, fine aggregate, coarse aggregate, admixtures, air, and water. All of these materials have different specific gravities.

A variation in the unit weight of a mixture will indicate a change in proportioning of the mixture, often in the water or air content.

Test Procedure—How Is the Test Run?

A sample of mixed concrete is consolidated in a container of known volume and weighed to determine the unit weight of the mixed concrete (ASTM C138).

Test Apparatus

- Cylindrical container, usually a standard pressure air pot, for measuring the mixture
- Scale for weighing the sample
- Tamping rod, vibrator, mallet, and strike-off plate for consolidating and striking off the sample in the air pot
- Record the empty mass, full mass, and volume of the air pot

Output—How Do I Interpret the Results?

The unit weight of the concrete mix is reported in pounds per cubic foot (lb/ft³) or kilograms per cubic meter (kg/m³):

Unit weight = (full mass – empty mass) ÷ volume

The unit weight of the mix should be compared with the unit weight of the mix design to identify potential problems in the batching process or changes in raw materials.

A variability of more than 5 lb/ft³ may be considered significant.

Construction Issues—What Should I Look For?

When variations in unit weight measurements are observed, the following potential causes should be reviewed:

- Sample consolidation (Was the sample fully consolidated in the air pot?)
- Air content of the concrete
- Batch proportions of each material
- Changes in raw material densities (specific gravities)

Flexural Strength and Compressive Strength (Seven Day)

Purpose—Why Do this Test?

Concrete strength is critical because it reflects concrete's ability to carry intended loads. Flexural and compressive strength testing are currently the standard methods of evaluating and assessing pay factors for pavement concrete. The tests are required for calibrating maturity-based monitoring systems.

Principle—What Is the Theory?

A measured force is applied to concrete samples of consistent cross-sectional area (beams and cylinders) until the samples fail. The force required to break the sample is used to calculate the strength based on the cross-sectional area of the sample.

Test Procedure—How Is the Test Run?

Samples of fresh concrete from the project are cast in cylinder and/or beam molds, and/or cores are obtained from the pavement. These test specimens are cured in laboratory conditions until they are broken in accordance with ASTM C39 (compression) or ASTM C78 (flexure). A consistent and continuously increasing force is applied to the test specimens by a hydraulic testing machine. The maximum force required to break the sample and the actual dimensions of each sample are recorded.

Test Apparatus

- Cylinder and beam molds for casting strength specimens (6 in. diameter × 12 in. height [or 4 × 8 in.] for cylinders and 6 in. width × 6 in. height × 24 in. length for beams) or cores
- Curing tanks to provide consistent curing conditions for the specimens
- Hydraulic testing frame for applying the force
- Cutoff saw, neoprene cap, and miscellaneous tools for preparing the specimens

Summary of Test Method

1. Sample and cast cylinder and beam specimens in accordance with standard procedures, or obtain cores from the hardened pavement
2. Cover and protect specimens from evaporation and damage for 24 hours
3. Remove specimens from the molds and transfer to the curing tanks or moist room
4. Cure the specimens in a controlled environment until they are broken
5. Remove the specimens from the curing tanks. Trim cylinders to length, taking care to avoid letting the specimens dry out before they are tested
6. Place the specimens in the hydraulic testing frame and apply a force at the specified loading rate until the specimen breaks
7. Record the maximum force applied and the dimensions of the specimen

Output—How Do I Interpret the Results?

Strength results are reported in a tabular format in units of pounds per square inch (lb/in²) or pascal (Pa). Other data in the report should include specimen identification, specimen dimensions, span length (beams), and maximum force applied.

These are the formulas for concrete strength calculations:

Flexural strength = $([\text{force} \times \text{span}] \div [\text{width} \times \text{depth}^2])$

Compressive strength = $\text{force} \div (\pi \times \text{radius}^2)$

Construction Issues—What Should I Look For?

Laboratory-cured strength tests are a representation of the concrete mix's strength properties. The strength of the pavement will differ from laboratory-molded and laboratory-cured specimens because of differences in consolidation and differences in the curing environment. Core specimens taken from the slab can be used to verify pavement strengths.

Conditions that may prevent the strength tests from being representative of the actual concrete strength include the following:

- The load rate does not conform to standard procedures; faster load leads to higher strength test results
- Beam specimens are allowed to dry before testing, resulting in lower strength test results
- Specimen dimensions are not uniform, resulting in lower strength test results
- Specimens are not adequately consolidated, resulting in lower strength test results
- Improper transport, curing, storage, and handling of the specimens

The strength of the concrete pavement structure is influenced by the following factors:

- W/cm ratio
- Air content
- Consolidation
- Curing conditions
- Aggregate grading, quality, and shape

Concrete strength has long been an acceptance criterion for concrete pavements. From a long-term performance standpoint, characteristics other than strength have a significant impact on pavement durability.

Adequate strength is a good indicator of concrete quality, but it does not guarantee performance. Focusing on strength alone may ignore important properties, such as air entrainment, permeability, and workability.

Concrete Maturity

Purpose—Why Do This Test?

Measuring the maturity of concrete pavements is a nondestructive test method for estimating in-place concrete strength. It is quickly becoming standard practice. Maturity may be used as a criterion for opening a pavement to traffic and for QC purposes.

Principle—What Is the Theory?

The degree of hydration (leading to strength) of a given mix design is a function of time and temperature. Correlation curves can be developed for a mix design that estimate concrete strength based on its maturity. The in-place strength of a pavement can be estimated by monitoring the temperature of the slab over time and using the correlation curve that was developed for that mixture.

A maturity curve (strength estimate based on maturity) is only applicable to a specific mix design.

Test Procedure—How Is the Test Run?

The maturity curve is developed by casting, curing, and testing standard-strength specimens while measuring and recording the temperature of those specimens over time (ASTM C1074).

Maturity testing is performed by inserting a temperature sensor in the slab and then downloading the temperature data to a computer that compares the slab temperature data to the maturity curve.

Test Apparatus

- Beams, cylinders, and hydraulic loading frame for strength testing to develop the maturity curve
- Sensors to measure the temperature of the test specimens and of the pavement
- Computer software to analyze strength, temperature, and time data for developing the maturity curve and estimating the pavement strength

Summary of Test Method

Maturity Curve (the time/temperature factor [TTF] method is described here; refer to appropriate ASTM/AASHTO procedures for the equivalent age procedure):

- Cast 13 strength specimens from materials that are mixed at the project site
- Completely embed a temperature sensor in one of the specimens; this specimen is used only for recording the temperature over time and will not be broken
- Cure all the strength specimens in the same location (constant temperature)
- Test the strength of the specimens at one, three, five, and seven days; break and average three specimens at each age
- Download and record the TTF for each set of strength specimens when they are broken
- Plot the strength and TTF data for the strength specimens on a graph, with TTF on the horizontal (x) axis and concrete strength on the vertical (y) axis
- Fit a smooth curve through the plotted points

In-Place Maturity (estimated strength):

- Completely embed a temperature sensor in the pavement
- Download the TTF from the sensor at any time
- Estimate the strength of the concrete pavement using computer software and the appropriate maturity curve

Output—How Do I Interpret the Results?

Commercially available maturity systems normally include software that provides the estimated concrete strength based on the maturity of the concrete (TTF). A sample maturity curve is shown in Figure 9-8.

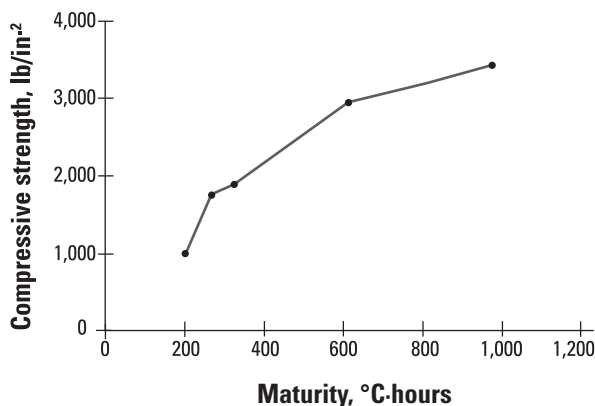

Figure 9-8. Sample maturity curve

Construction Issues—What Should I Look For?

Maturity testing is a way of nondestructively estimating the strength of a concrete pavement and is used exclusively for opening to traffic. Maturity testing is not a replacement for compressive or flexural strength testing for acceptance.

It cannot be overemphasized that the maturity versus strength relationship is mix specific. Maturity estimates of in-place strength are valid only if the pavement being tested is constructed using the same mix design that was used to develop the maturity curve.

Changes in the w/cm ratio, air content, grading, aggregate proportions, admixtures, etc., may cause a maturity curve to overestimate or underestimate the strength of the pavement. Basing the maturity curve on a batch of concrete with air content and a w/cm ratio near the upper end of the specification range can build conservatism into the strength estimates.

Resistivity/Formation Factor

Purpose—Why Do This Test?

The ability of concrete to resist the transportation of aggressive fluids is an important factor in its potential durability. The test method provides an indirect measure of the permeability of the concrete, a critical parameter in all durability-related distress mechanisms. The lower the permeability, the longer the concrete will survive chemical attack.

Principle—What Is the Theory?

The permeability of concrete can be indirectly assessed by measuring the surface resistivity of a sample of concrete. The test is based on the fact that it is easier to transport an ionic charge through fluids than through solids. The higher the resistivity of a saturated sample, the lower the volume and connectivity of the fluid-filled voids and, hence, the lower the permeability.

The F-factor can be used to characterize the pore structure of concrete because it is a value that is only dependent on the pore geometry and connectivity. The F-factor is defined as the ratio of the resistivity of a bulk body (ρ) and the resistivity of the pore solution in the body ($\rho\phi$). The F-factor can be calculated from the resistivity of a sample with a known moisture state.

Test Procedure—How Is the Test Run?

The 4-probe test is described in AASHTO T 358-15, and a uniaxial version is described in AASHTO TP 119. A cylinder or core sample is moisture conditioned by soaking in a specified salt solution for 5 days.

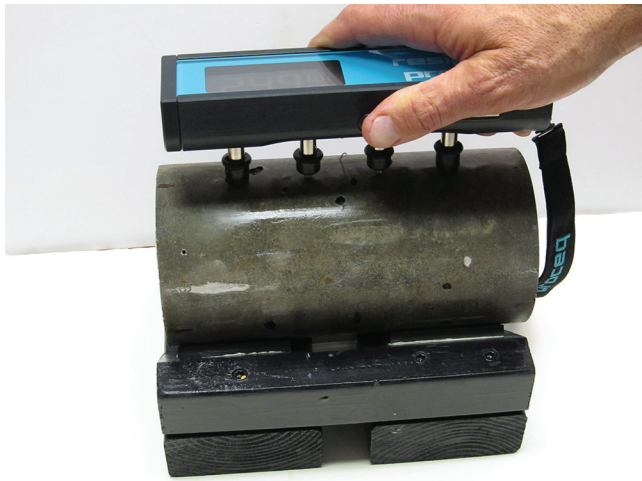

Figure 9-9. Surface resistivity gauge

The surface resistivity test is conducted by placing the device in contact with the concrete sample and recording a reading (Figure 9-9).

Test Apparatus

- Surface resistivity device

Output—How Do I Interpret the Results?

Surface resistivity is reported in kohm-cm. Higher numbers indicate a lower permeability, which is desirable. Permeability values are categorized in [Table 6-4](#).

Construction Issues—What Should I Look For?

The same sample can be tested at several ages. Early-age data can be compared to the expected development data collected during the prequalification stage.

Mix design issues that can influence permeability include the following:

- Lower w/cm ratio will lead to lower permeability
- Use of fly ash, slag cement, and silica fume will generally reduce permeability

Paving process inputs that influence permeability include the following:

- Improved consolidation will reduce permeability
- Premature final finishing when excessive bleed water is present will increase surface permeability
- Proper curing will decrease permeability

Sorption

Purpose—Why Do This Test?

The rate at which aggressive fluids are absorbed into a sample, and the total degree of saturation (what percentage of the voids are filled with fluid) provide a good indication of the ability of the concrete to resist the environment, including freezing.

Principle—What Is the Theory?

The rate of water absorbed into a conditioned thin concrete sample is measured over a period of time. The slope of the line of mass of water absorbed against the square root of time ($s^{1/2}$) typically makes a distinctive change at some point, thus defining initial absorption and secondary absorption. Initial absorption is considered to be controlled by capillaries filling with water; whereas, the slower secondary absorption is controlled by the air voids filling with water.

Rapid sorption indicates a higher risk of aggressive fluids penetrating the concrete, as well as shortening the time to reach a critical saturation in which the material is unable to resist freezing.

Test Procedure—How Is the Test Run?

A 2 in. thick \times 4 in. diameter cylinder is preconditioned to a given moisture state and the sides are sealed. It is weighed before being placed in a shallow bath of water and weighed again at regular intervals for 9 days. The increase in mass is plotted against the square root of time.

Test Apparatus

- Pan
- Balance
- Paper towel to dry sample surface before weighing
- Environmental chamber to precondition the sample
- Stopwatch
- Caliper to measure sample dimensions

Output—How Do I Interpret the Results?

The time to reach critical saturation (85 percent) can be calculated from the slope of secondary absorption. The time should be greater than 30 years.

Construction Issues—What Should I Look For?

Performance of the mixture can be improved by the following:

- Reduce the w/cm ratio
- Improve the air-void system
- Adjust SCM dosage
- Ensure that curing is adequate

Water/Cementitious Materials Ratio (Microwave)

Purpose—Why Do This Test?

The performance of concrete used for pavements is mainly a function of the w/cm ratio of the mixture. Acceptance strength tests on hardened concrete are normally performed at least 7 days after placement of the concrete. The microwave method can be used to obtain w/cm ratio results within hours, instead of waiting days for strength results. Monitoring the test results may provide an early flag of potentially low-strength concrete, allowing the contractor to adjust operations sooner than conventional strength testing might indicate.

In simplest terms, less water implies higher performance. Other factors, such as consolidation, curing, aggregate quality, air content, and aggregate shape, affect strength as well. For a given mix with a constant amount of cement, the w/cm ratio has the greatest impact on strength.

Principle—What Is the Theory?

The total water in a concrete mix comes from the following sources:

- Moisture absorbed in the aggregate
- Free water on the aggregate
- Water added in the batching process

The mass of water removed from a fresh mixture by drying in a microwave can be used to calculate the w/cm ratio of the mixture.

Test Procedure—How Is the Test Run?

The test is described in AASHTO T 318. A sample of fresh concrete from the project is weighed and then dried in a microwave. It is then reweighed to determine the mass of water that was contained in the mix. The water absorbed in the aggregate is subtracted from this total, and the remainder is used to calculate the w/cm ratio using the batched cementitious materials content.

Test Apparatus

- Microwave oven for drying the concrete sample
- Glass pan and fiberglass cloth (a container for the concrete sample)
- Scale to obtain the mass of the sample
- Porcelain pestle for grinding the sample as it is dried

Output—How Do I Interpret the Results?

The total water content of the concrete sample can be expressed as a percentage:

$$\text{Total water content \% } (W_t) = (\text{wet sample mass} - \text{dry sample mass}) \div \text{wet sample mass}$$

This W_t can be monitored and used as a relative indicator of potential variability in pavement strength.

It should be noted that the value of W_t will not provide the true w/cm ratio because the microwave test drives out all of the water in the concrete, including the water that is absorbed in the aggregate. As such, the value of W_t will be greater than the true w/cm ratio of the mix. By compensating for the measured absorption of the aggregate, the result from this test can be used to monitor variability in the concrete from batch to batch.

Construction Issues—What Should I Look For?

When variations in W_t are noted, plant operations should be reviewed to ensure that materials are being batched in the proper proportions.

Semi-Adiabatic Calorimetry

Purpose—Why Do This Test?

Semi-adiabatic calorimetry (ASTM C1753) provides information about the hydration kinetics of a mixture, thus flagging potential interactions between the reactive ingredients, as well as measuring comparative heat gain and initial setting time.

Principle—What Is the Theory?

Chemical reactions that occur as concrete hardens emit heat (heat of hydration). By insulating a standard cylinder of concrete from the influence of outside temperatures and using sensors to record the heat generated by the concrete, it is possible to measure the adiabatic heat signature of a concrete mix. A chart that plots time on the x-axis and temperature on the y-axis is produced from this data.

Test Procedure—How Is the Test Run?

A concrete cylinder is placed inside an insulated container that is equipped with temperature sensors that record the temperature inside the container at regular intervals.

Test Apparatus

- Semi-adiabatic calorimeter

Output—How Do I Interpret the Results?

The basic analysis of the heat signature consists of a graph of time vs. temperature. Plotting multiple samples on the same chart may reveal differences in the mix's chemistry (Figure 9-10).

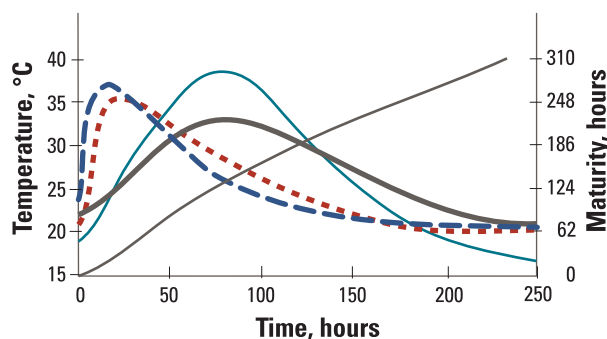

Figure 9-10. Heat signature sample plots

Construction Issues—What Should I Look For?

Changes in the temperature time curve between batches may indicate the following:

- Changes in the chemistry of the source materials
- Changes in mixture proportions—e.g., admixture dosages
- Incompatibility between ingredients

Changes in heat signature may impact the following concrete properties:

- Slump loss
- Setting time
- Rate of strength gain

Concrete Temperature, Subgrade Temperature, and Project Environmental Conditions

Purpose—Why Do This Test?

Interactions between concrete pavements and the environment during construction have the potential to adversely impact the constructability and durability of concrete pavements. Collecting, monitoring, recording, and responding to the temperature of the concrete and the underlying base course, along with weather data from the construction site, will allow the construction team to minimize the risk of problems.

Principle—What Is the Theory?

Environmental factors, such as temperature, relative humidity, wind velocity, solar radiation, and temperature changes, influence the rate of hydration, setting time, and strength gain of a slab, thus changing the saw-cutting window and the risk of cracking or curling.

Test Procedure—How Is the Test Run?

1. Concrete (ASTM C1064) and ambient temperatures are taken with a thermometer when the concrete is sampled
2. Subgrade temperature is taken with a pyrometer in front of the paver when the concrete is sampled
3. Project environmental conditions are recorded using a portable weather station

Test Apparatus

- Thermometer to measure concrete temperature
- Pyrometer to measure subgrade temperature
- Weather station to measure project environmental conditions

Output—How Do I Interpret the Results?

Temperatures and environmental conditions should be reported in a tabular format. Changes in temperature, wind speed, and humidity should be monitored and may require changes in mix proportions or construction practice.

Construction Issues—What Should I Look For?

Concrete temperatures should be monitored. Temperatures above 95°F may affect workability.

Thermal gradients in the slab result in curling, which increases the internal stresses in the slab and may cause early-age cracking. This condition may be aggravated by high subgrade temperatures at the time of placement.

Many combinations of weather conditions can adversely affect a concrete pavement. The following are the primary conditions to observe:

- High temperatures may increase the risk of incompatibility between the reactive components of a mix
- Hot, dry, windy conditions contribute to plastic shrinkage cracking
- Cold conditions will increase the time of setting
- Sudden cold fronts can cause premature cracking
- Rain can damage the surface of fresh concrete unless the surface is protected

There is an inherent risk in the construction of concrete pavements. Weather conditions are beyond the contractor's control, and forecasts are not entirely reliable. Even with experience and the best judgment, conditions may arise that can result in damage to a concrete pavement.

Coefficient of Thermal Expansion

Purpose—Why Do This Test?

The expansion and contraction of concrete due to temperature changes can impact the durability of joints and the risk of cracking in concrete pavements.

Principle—What Is the Theory?

Concrete expands and contracts as its temperature changes. When a saturated cylinder of concrete is exposed to changing temperature conditions, its change in length can be measured by a linear variable differential transformer (LVDT).

Test Procedure—How Is the Test Run?

A saturated concrete cylinder or core is subjected to temperature changes from 50°F to 120°F. The change in length of the cylinder is measured and recorded at different temperatures (AASHTO T 336).

Test Apparatus

- Caliper: Measures the initial length of the core specimen
- Water tank: Maintains saturation of the sample and varies the temperature of the water from 50°F to 120°F
- Support frame: Holds the core specimen and the LVDT
- Thermometer: Measures the water temperature
- LVDT: Measures the length change of the specimen (resolution = 0.00001 in.)

Output—How Do I Interpret the Results?

The coefficient of thermal expansion (CTE) is a function of length change due to a change in temperature.

$$\text{CTE} = (\text{measured length change/specimen length}) \div \text{measured temperature change}$$

The CTE reported is the average of both test values.

The CTE is reported in microstrain/°F. Typical values for concrete can range from 4(10⁻⁶) to 7(10⁻⁶)°F. The CTE is most affected by aggregate type. Concrete produced with siliceous aggregates has a higher CTE than concrete produced with limestone aggregates.

Construction Issues—What Should I Look For?

Thermal expansion/contraction is a factor that should be considered in the design phase. During construction, the following items should be monitored for conformity with the plans to avoid the possible adverse effects of thermal expansion and contraction:

- Joint layout and spacing
- Joint width

Pavement Thickness

Purpose—Why Do This Test?

The service life of a concrete pavement is significantly influenced by the pavement thickness.

Principle—What Is the Theory?

The MIT-SCAN-T3 is a device that uses pulse induction technology to measure pavement thickness nondestructively.

Test Procedure—How Is the Test Run?

A metal target must be pre-placed on the top of the base. The MIT-SCAN-T3 device detects the plate, and

pulse induction is utilized to determine the thickness of the concrete pavement. The device reports the thickness of the pavement, reportedly within 0.08 in. of measured core lengths.

Output—How Do I Interpret the Results?

Reported pavement thickness is compared with the specified requirement.

Construction Issues—What Should I Look For?

Pavement thickness is controlled by paving machine calibration and adjustment taking into account variability of the base.

Dowel Bar Alignment

Purpose—Why Do This Test?

Dowel bars are intended to provide vertical load transfer between slabs without inhibiting horizontal movements. Bars that are misaligned have the potential to lock the slabs together and thus induce cracking.

Principle—What Is the Theory?

The MIT-DOWEL-SCAN device emits a pulsating, magnetic signal and detects the transient magnetic response induced by the metal dowel bars. The signals are interpreted to report horizontal and vertical alignment, side shift, and depth of the dowel bar from the top of the pavement.

Test Procedure—How Is the Test Run?

The device is pulled across the pavement over the joint along the rails provided with the device. An image of the bar locations is downloaded to a computer.

The test can be run as soon as the concrete is hard enough to walk on.

Output—How Do I Interpret the Results?

Data files are provided that report locations of the bars. These can be compared with specified limits.

Construction Issues—What Should I Look For?

Dowel cages can be displaced by the paver if they are not properly secured. Dowels inserted from above may also be displaced if the mixture is not workable enough or if the equipment is not set up correctly.

This tool helps determine whether the bars are in the correct location.

Smoothness

Purpose—Why Do This Test?

Pavement smoothness is one of the key functional characteristics to which the road user pays attention. It also leads to longer pavement life. Many agencies have moved from the Profilograph Index to the IRI for acceptance. This transition to the IRI can prove to be a challenge for contractors striving to achieve initial pavement smoothness while minimizing corrective actions (grinding).

Principle—What Is the Theory?

The true profile of the road (bumps and dips) is measured using a lightweight inertial profiler (see Figure 8-25) or high-speed profiler equipped with line lasers and an accelerometer to negate suspension movement during testing (Figure 9-11). This profile is then loaded into a computer model, which simulates the reaction of a standard vehicle suspension yielding the IRI in inches per mile.

Test Procedure—How Is the Test Run?

The inertial profiler travels along the pavement with the laser sensors centered on a wheel path collecting profile data. The pavement should be cleaned prior to testing.

Test Apparatus

- Inertial profiler
- Computer with ProVAL software



Figure 9-11. High-speed inertial profiler

Test Method

- Sweep the pavement clean
- Operate the inertial profiler according to specified standards and collect raw profile data
- Process the profile data through an IRI model using ProVAL software
- Identify areas needing corrective action

Output—How Do I Interpret the Results?

Raw profile data consist of a series of closely spaced height measurements and reflect bumps and dips (Figure 9-12).

Once these data are processed through ProVAL, there are two primary ways to review them:

- A roughness report (Figure 9-13) shows the running average for IRI over a predefined base length; 0.10 mi is the most common base length. It can be used to identify areas of roughness and areas needing corrective action.
- A power spectral density (PSD) plot (Figure 9-14) shows if there are any predominant repeating wavelengths that are contributing to pavement roughness. If any repeating wavelengths are identified, the paving process can be adjusted to mitigate these wavelengths and improve the initial smoothness.

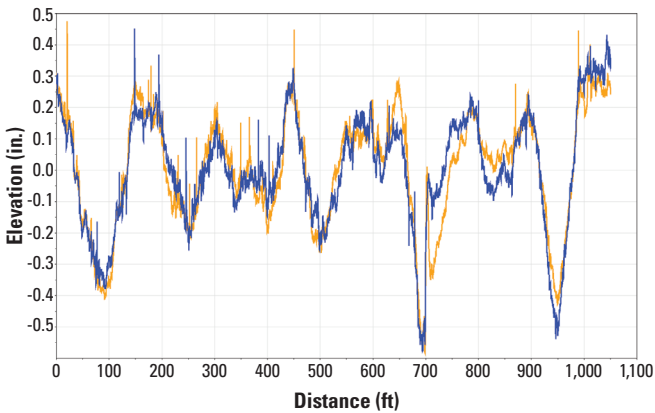

The Transtec Group, Inc., used with permission

Figure 9-12. Raw profile data

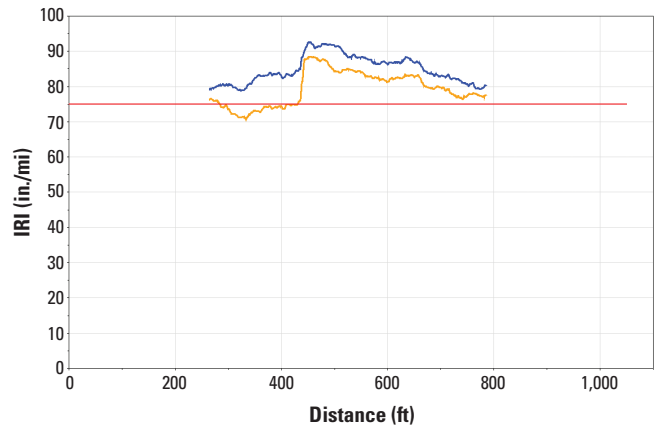

The Transtec Group, Inc., used with permission

Figure 9-13. ProVAL roughness report

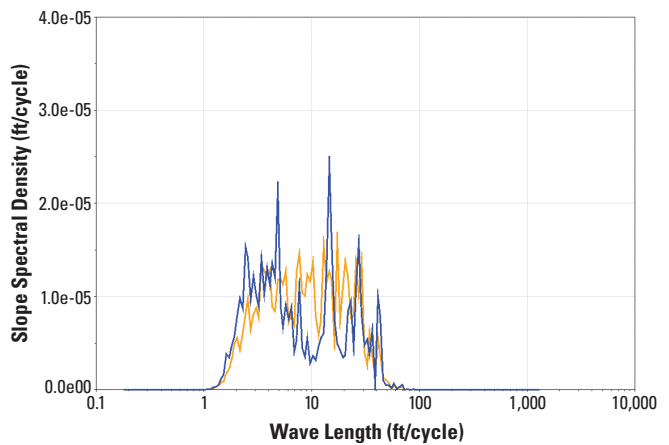

The Transtec Group, Inc., used with permission

Figure 9-14. ProVAL power spectral density plot showing a repeating wavelength at 15 ft that corresponds to joint spacing

Construction Issues—What Should I Look For?

Many factors can influence the initial pavement smoothness. They include, but are not limited to, the following:

- Combined gradation
- Between-batch uniformity
- Uniform delivery of concrete—maintaining a uniform paving speed and minimizing paver stops
- Trackline—stability and width
- String line/stringless model
- Paver setup
 - Draft/lead
 - Sensitivities
 - Vibrator frequency
 - Vibrator height
 - Float pan

- Concrete head
- Hand finishing to remove short wavelength roughness
- Curing and texturing
- Human factors—training, experience, communication, and empowerment

Smoothness can also be measured in real time (Figure 9-15) directly behind the paver. Monitoring RTS is not a replacement for acceptance testing, but it does shorten the feedback loop from 24 to 48 hours to 1 or 2 hours. Having real-time feedback regarding pavement smoothness provides an advantage when diagnosing and correcting smoothness issues related to material variability and paver adjustments.



The Transtec Group, Inc., used with permission

Figure 9-15. Real-time smoothness devices: Gomaco GSI (left) and Ames Engineering RTP (right)

References

AASHTO PP 84 *Standard Practice for Developing Performance Engineered Concrete Pavement Mixtures.*

AASHTO T 22 *Standard Method of Test for Compressive Strength of Cylindrical Concrete Specimens.*

AASHTO T 27 *Standard Method of Test for Sieve Analysis of Fine and Coarse Aggregates.*

AASHTO T 336 *Standard Test Method for the Coefficient of Thermal Expansion of Hydraulic Cement Concrete.*

AASHTO T 84 *Standard Method of Test for Specific Gravity and Absorption of Fine Aggregate.*

AASHTO T 85 *Standard Method of Test for Specific Gravity and Absorption of Coarse Aggregate.*

AASHTO T 97 *Standard Method of Test for Flexural Strength of Concrete (Using Simple Beam with Third-Point Loading).*

AASHTO T 119 *Standard Method of Test for Slump of Hydraulic Cement Concrete.*

AASHTO T 121 *Standard Method of Test for Density (Unit Weight), Yield, and Air Content (Gravimetric) of Concrete.*

AASHTO T 152 *Standard Method of Test for Air Content of Freshly Mixed Concrete by the Pressure Method.*

AASHTO T 153 *Standard Method of Test for Fineness of Hydraulic Cement by Air Permeability Apparatus.*

AASHTO T 185 *Standard Method of Test for Early Stiffening of Portland Cement (Mortar Method).*

AASHTO T 196 *Standard Method of Test for Air Content of Freshly Mixed Concrete by the Volumetric Method.*

AASHTO T 255 *Standard Method of Test for Total Evaporable Moisture Content of Aggregate by Drying.*

AASHTO T 277 *Electrical Indication of Concrete's Ability to Resist Chloride Ion Penetration.*

AASHTO T 309 *Standard Method of Test for Temperature of Freshly Mixed Portland Cement Concrete.*

AASHTO T 318 *Standard Method of Test for Water Content of Freshly Mixed Concrete Using Microwave Oven Drying.*

AASHTO T 325 *Standard Method of Test for Estimating the Strength of Concrete in Transportation Construction by Maturity Tests.*

AASHTO T 358-15 *Standard Method of Test for Surface Resistivity Indication of Concrete's Ability to Resist Chloride Ion Penetration.*

AASHTO TP 118 *Standard Method of Test for Characterization of the Air-Void System of Freshly Mixed Concrete by the Sequential Pressure Method 118.*

AASHTO TP 119-15 *Standard Method of Test for Electrical Resistivity of a Concrete Cylinder Tested in a Uniaxial Resistance Test.*

AASHTO TP 129 *Standard Method of Test for Vibrating Kelly Ball (Vkelly) Penetration in Fresh Portland Cement Concrete.*

ASTM C29 *Standard Test Method for Bulk Density ("Unit Weight") and Voids in Aggregate.*

ASTM C39 *Standard Test Method for Compressive Strength of Cylindrical Concrete Specimens.*

ASTM C70-13 *Standard Test Method for Surface Moisture in Fine Aggregate.*

ASTM C78-02 *Standard Test Method for Flexural Strength of Concrete (Using Simple Beam with Third-Point Loading).*

ASTM C94/C94M-04a *Standard Specification for Ready-Mixed Concrete.*

ASTM C127-15 *Standard Test Method for Density, Relative Density (Specific Gravity), and Absorption of Coarse Aggregate.*

ASTM C128-15 *Standard Test Method for Density, Relative Density (Specific Gravity), and Absorption of Fine Aggregate.*

ASTM C136 *Standard Test Method for Sieve Analysis of Fine and Coarse Aggregates.*

ASTM C138/C138M-01a *Standard Test Method for Density (Unit Weight), Yield, and Air Content (Gravimetric) of Concrete.*

ASTM C143 *Slump of Hydraulic Cement Concrete.*

ASTM C173/C173M-01e1 *Standard Test Method for Air Content of Freshly Mixed Concrete by the Volumetric Method.*

ASTM C204 *Standard Test Method for Fineness of Hydraulic Cement by Air-Permeability Apparatus.*

ASTM C231/231M *Standard Test Method for Air Content of Freshly Mixed Concrete by the Pressure Method.*

- ASTM C359 *Standard Test Method for Early Stiffening of Hydraulic Cement (Mortar Method)*.
- ASTM C457-98 *Standard Test Method for Microscopical Determination of Parameters of the Air-Void System in Hardened Concrete*.
- ASTM C531 *Standard Test Method for Linear Shrinkage and Coefficient of Thermal Expansion of Chemical-Resistant Mortars, Grouts, Monolithic Surfacing, and Polymer Concretes*.
- ASTM C566-97 *Standard Test Method for Total Evaporable Moisture Content of Aggregate by Drying*.
- ASTM C1064/C1064M *Standard Test Method for Temperature of Freshly Mixed Hydraulic-Cement Concrete*.
- ASTM C1074 *Standard Practice for Estimating Strength by the Maturity Method*.
- ASTM C1077 *Standard Practice for Agencies Testing Concrete and Concrete Aggregates for Use in Construction and Criteria for Laboratory Evaluation*.
- ASTM C1202 *Standard Test Method for Electrical Indication of Concrete's Ability to Resist Chloride Ion Penetration*.
- ASTM C1383 *Standard Test Method for Measuring the P-Wave Speed and the Thickness of Concrete Plates Using the Impact-Echo Method*.
- ASTM C1585 *Measurement of Rate of Absorption of Water by Hydraulic-Cement Concretes*.
- ASTM C1753 *Standard Practice for Evaluating Early Hydration of Hydraulic Cementitious Mixtures Using Thermal Measurements*.
- ASTM D4748 *Standard Test Method for Determining the Thickness of Bound Pavement Layers Using Short-Pulse Radar*.
- ACPA. 2018. *Database of State DOT Concrete Pavement Practices*. American Concrete Pavement Association, Skokie, IL.
- ACPA. 2005. *Dowel Basket Tie Wires: Leaving Them Intact Does Not Affect Pavement Performance*. R&T Update 6.01, American Concrete Pavement Association, Skokie, IL.
- ACPA 2019. *ACPA Guide Specification: Dowel Bar Alignment and Location*. American Concrete Pavement Association. Rosemont, IL.
- FHWA. 2012. *Construction Quality Assurance*. Federal Highway Administration, Washington, DC. <https://www.fhwa.dot.gov/federal-aidessentials/companionresources/16quality.pdf>.
- Grove, J., G. Fick, T. Rupnow, and F. Bektas. 2008. *Material and Construction Optimization for Prevention of Premature Pavement Distress in PCC Pavements*. National Concrete Pavement Technology Center, Iowa State University, Ames, IA.
- Khazanovich, L., K. Hoegh, and M. Snyder. 2009. *NCHRP Report 637: Guidelines for Dowel Alignment in Concrete Pavements*. National Cooperative Highway Research Program, Washington, DC. http://onlinepubs.trb.org/onlinepubs/nchrp/nchrp_rpt_637.pdf.
- Kosmatka, S. and M. Wilson. 2016. *Design and Control of Concrete Mixtures*. 16th Edition. Portland Cement Association, Skokie, IL.
- Landgren, R. 1994. Unit Weight, Specific Gravity, Absorption, and Surface Moisture. Chapter 37 in *Significance of Tests and Properties of Concrete and Concrete Making Materials*. American Society for Testing and Materials, West Conshohocken, PA. pp. 421–428.
- Seward, K., et al. 2004. Oklahoma Department of Transportation Draft Special Provision. *Quality Control and Acceptance Procedures for Optimized Portland Cement Concrete Pavements*. 414-10QA(a-x) 99. Oklahoma Department of Transportation, Oklahoma City, OK.
- Snyder, M. B. 2011. *Guide to Dowel Load Transfer Systems for Jointed Concrete Roadway Pavements*. National Concrete Consortium, Ames, IA.
- Steffes, R. and S. Tymkowicz. 2002. Vibrator Monitors Concrete Paving Technology Generates Buzz. *Transportation Research News*, pp. 19–20. <http://onlinepubs.trb.org/onlinepubs/trnews/rpo/rpo.trn223.pdf>.
- TRB. 2013. *Glossary of Transportation Construction Quality Assurance Terms*. Sixth Edition. Research Circular E-C173. Transportation Research Board, Washington, DC.
- Welchel, D. 2014. 2014. Determining the Size and Spacing of Air Bubbles in Fresh Concrete. MS thesis. Oklahoma State University, Stillwater, OK.
- Yu, H. T. 2005. *Dowel Bar Alignments of Typical In-Service Pavements*. SN2894. Portland Cement Association, Skokie, IL.

1	Intro
2	Sustainability
3	Design
4	Materials
5	Hydration
6	Properties
7	Mixtures
8	Construction
9	QA/QC
10	Troubleshooting

Chapter 10

Troubleshooting and Prevention

Overview	276
Before the Concrete Has Set	276
After the Concrete Has Set	284
In the First Days after Placing	284
Some Time after Construction	289
References	293

Overview

Most materials-related problems that occur during paving operations are due to actions taken or conditions met during materials selection or concrete mixing and placing. To prevent and fix problems, all members of the construction team need to understand the materials they are working with and be prepared to address potential scenarios.

Inappropriate repairs may fail to correct the problem and may not last. It is essential, therefore, that before changes are made or remedial action taken, the cause of a problem is understood. This may involve investigative work to uncover the mechanisms and sources of the distress. When doing this type of investigation, it is important to make accurate observations and document them (Harrington et al. 2018).

Begin any investigation by looking for patterns that may connect cause and effect. In particular, look for changes that may have led to the problem.

Possibilities may include weather changes, a change in material source or quality, and staffing changes. Problems are often a combination of factors, including design and detailing, materials selection and proportioning, and construction practices. A project may be proceeding satisfactorily, but a small change in any one of these factors may tip the balance and result in a problem.

Not all problems are observed in the early stages; some become apparent only later. This chapter contains tables that recommend actions to be taken when problems are observed—before the concrete has set (see plastic shrinkage cracks in Figure 10-1), during the first few days after placement (see other early-age cracks in Figure 10-1), or at some time after the concrete has hardened. The tables refer to sections in this manual where detailed information can be found about the factors that may have contributed to the problem.

Before the Concrete Has Set

Some paving problems are generally observed up to the time of final set (Table 10-1). Some of these, like insufficient air in the concrete, can be fixed immediately if they are observed early enough. In such cases, admixture dosages might be adjusted if allowed by the specification and good practice.

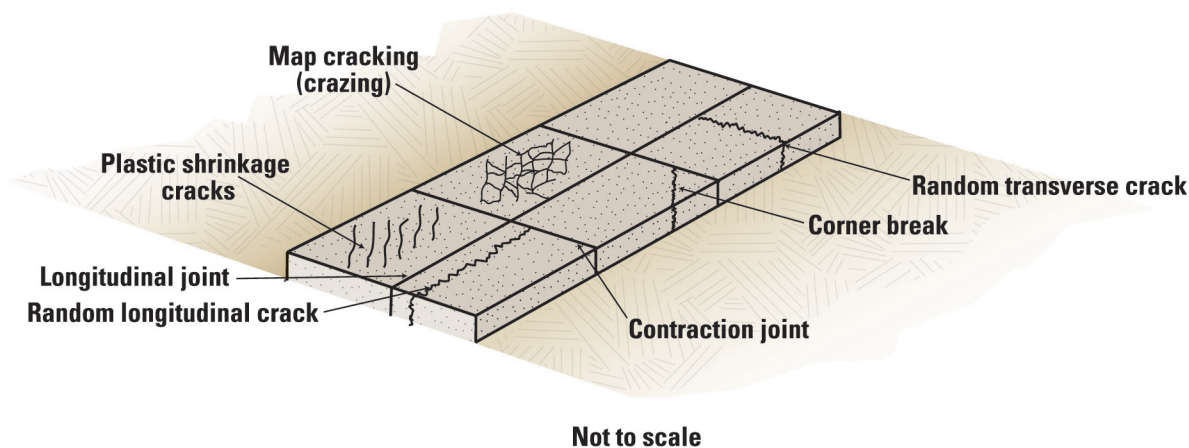

Figure 10-1. Early-age cracking

Table 10-1. Problems observed before the concrete has set

Mixture and placement issues

1. Slump is out of specification

Potential cause(s)	Actions to consider/avoid
Change in water content or aggregate grading	Check aggregate moisture contents and absorptions.
	Check for segregation in the stockpile.
	Make sure the batch water is adjusted for aggregate moisture content.
	Conduct batch plant uniformity tests.
Mix proportions	Check whether water was added at the site.
Admixture dosage	Check batch equipment for calibration.
Concrete temperature too high or too low	Check delivery ticket for correct admixture dosage.
Haul time	Adjust the concrete placement temperature.
	Check the batch time on the concrete delivery ticket. Haul times should not be excessive.

2. Loss of workability/slump loss/early stiffening

Potential cause(s)	Actions to consider/avoid
Dry coarse aggregates	Make sure the aggregate stockpile is kept consistently at saturated surface-dry (SSD) (use soaker hoses if necessary).
Ambient temperature increases	Do not add water.
	Chill the mix water or add ice.
	Sprinkle the aggregate stockpiles.
	Use a water reducer or retarder.
	Do not increase the water/cement ratio to a value greater than the maximum approved mix design.
Transport time too long	Use a mix design that includes slag or fly ash.
	Reject the load if greater than specified.
	Use retarder in the mixture.
Mix proportions have changed	Use an agitator rather than dump trucks.
	Check/monitor the moisture contents of the aggregate stockpiles.
False setting (temporary)	Check the batch weigh scales.
	Verify that aggregate gradations are correct.
	Check for changes in cementitious materials.
	Reduce Class C fly ash replacement.
	Change the type of water reducer.
Incompatibility	Try restoring plasticity with additional mixing.
	Contact the cement supplier.
	Check for changes in the cementitious materials.
	Reduce Class C fly ash replacement.
Variation in air content	Change chemical admixtures.
	Change the batching sequence.
	Cool the mixture.
	Check the air content/air entrainer dosage.

Mixture and placement issues, continued

3. Mixture is sticky

Potential cause(s)	Actions to consider/avoid
Sand too fine	Change the sand grading.
Mix too sandy	Check the sand and combined aggregate grading.
Cementitious materials	Check the cementitious materials contents. (Mixtures containing ground granulated blast furnace [GGBF] slag and fly ash appear sticky but finish well and respond well to vibration energy.)
	Lower the vibration energy to avoid segregation.
	Adjust the mix proportioning.
Using wood float on air-entrained concrete	Use magnesium or aluminum floats.

4. Mixture segregates

Potential cause(s)	Actions to consider/avoid
Inconsistent concrete material— batching, mixing, placing	Check aggregate gradation; poorly graded mixtures may tend to segregate.
	Verify batching/mixing procedures so that the mixture is adequately mixed.
	Check aggregate stockpile, storage, and loading procedures to prevent aggregate segregation.
	Place concrete as close to final position as possible to minimize secondary handling.
	Perform uniformity testing on batch plant, if necessary, use agitator trucks for transport.
	Reduce the vibration energy if consolidation efforts cause segregation. (Vibration at 5,000–8,000 vpm is sufficient for most well-graded mixtures.)

5. Excessive fresh concrete temperature

Potential cause(s)	Actions to consider/avoid
Hot ingredients	Do not add water.
	Follow hot-weather concreting practice as appropriate.
	Chill the mix water or use ice.
	Shade and sprinkle the aggregate stockpiles.
Long haul times	Adjust the hauling operation to minimize haul times.
	Adjust paving time to off-peak traffic time if hauling through public traffic.
Hot weather	Follow hot-weather concreting practice as appropriate.
	Chill the mix water; sprinkle the aggregate stockpiles.
	Pave at night or start paving in afternoon.

6. Air content is too low or too high

Potential cause(s)	Actions to consider/avoid
Temperature changes	The air-entraining admixture dosage may need to be adjusted during hot/cold weather.
Materials have changed	Check for uniformity of materials.
Mix proportions have changed	Altering other admixture dosages may impact the effectiveness of the air-entraining admixture.
	Check slump; it is easier to entrain air with increasing concrete workability.
	Check/monitor the moisture contents of the aggregate stockpiles.
	Check the batch weigh scales.
	Verify that aggregate gradations are correct.
Short or inadequate mixing	Verify sand quantity.
	Check the charging sequence.
	Increase mixing time.
	Check if the blades of the mixer are missing or dirty.

7. Variable air content/spacing factor

Potential cause(s)	Actions to consider/avoid
Incorrect or incompatible admixture types	Change types or brands of admixtures.
	Try to work within one manufacturer's family of admixtures if air-entraining agent is being combined with other admixtures.
Admixture dosage	Check the batching equipment for calibration and settings.
	Change the sequence of batching.
Mix proportions have varied or changed	Check/monitor the moisture contents of the aggregate stockpiles.
	Check the batch weigh scales.
	Verify that aggregate gradations are correct.
Cementitious materials	Check for changes in cementitious materials, particularly the loss-on-ignition (LOI) content of fly ash.
Poor plant configuration	Introduce aggregates together on the plant's belt feed (requires a multiple weigh hopper).
Poor aggregate grading	Use a more well-graded coarse and fine aggregate mixture.
	Check variation in the amount of materials retained on the #30 through #100 sieves.
Temperature changes	Air-entraining admixture dosage may need to be adjusted during hot/cold weather.
	Altering other admixture dosages may impact the effectiveness of the air-entraining admixture; air-entraining admixtures work more efficiently with increasing workability.
Variable mixing	Ensure that each batch is handled consistently in the plant.

Mixture and placement issues, continued

8. Mix sets early

Potential cause(s)	Actions to consider/avoid
Cementitious materials	Check for changes in the cementitious materials; differing sources or changes in properties of a given material may result in incompatibility; changes in proportions may also affect setting times.
Admixture dosage	Check the dosage of chemical admixtures, particularly accelerators.
	Check the batching equipment.
Hot weather	Adjust the mix proportions.
	Use mix designs that include GGBF slag or fly ash.
	Use a retarder.
	Reduce haul time if possible.
	Reduce the placement temperature of the concrete.
	In hot weather, use a hot weather mix design.
	Cool the concrete ingredients.

9. Delayed set

Potential cause(s)	Actions to consider/avoid
Excessive retarder dosage	Verify the proper batch proportions.
	Check the batching equipment.
	Reduce the dosage of the retarder.
Excessive water reducer dosage	Verify the proper batch proportions.
	Reduce the dosage of the water reducer.
Retarder not dispersed well	Improve mixing to disperse the retarder.
Supplementary cementitious materials interference	Reduce GGBF slag content; GGBF slag in excess of 25 percent can cause a dramatic increase in set time.
	Eliminate/reduce fly ash content in the mix.
Cold placement temperature	Follow cold-weather concreting practices if appropriate.
Organic contamination	Verify the proper batch proportions.
	Check for contamination of water and aggregates.

10. Supplier breakdown, demand change, raw material changes

Potential cause(s)	Actions to consider/avoid
Cement	Refer to backup lab mixes if conditions were anticipated.
	Switch sources, batch new mix designs, and develop new laboratory strength gain and maturity information. (This action may require a project delay. To avoid unacceptable delays, a contractual agreement should be arranged prior to paving, which allows for unforeseen material supply changes, burden of delay costs, and risk of paving during batch revision testing. If paving activity is continued during testing, compare early-age strengths [1- and 3-day] and maturity data to confirm that the new mix will perform adequately.)
Supplementary cementitious materials	See cement supply change.
	Switch sources and compare early-age strengths (1- and 3-day) and maturity data to confirm that the mix will perform adequately.
Aggregates	See cement supply change.
	Switch sources and compare early-age strengths (1- and 3-day) and maturity data to confirm that the mix will perform adequately.
Chemical admixtures	See cement supply change.
	Switch admixture sources and compare early-age strengths (1- and 3-day) and maturity data to confirm that the mix will perform adequately.

Edge and surface issues

11. Fiber balls appear in mixture

Potential cause(s)	Actions to consider/avoid
Fibers not thoroughly dispersed in mix	If added in bags, check the timing of addition and subsequent mixing.
	Some mixes do not break down bags as easily as others (i.e., smaller sized rounded coarse aggregate mixes); check compatibility.
	Use a blower for synthetic fibers or a belt placer for steel fibers instead of bags.

12. Concrete surface does not close behind paving machine

Potential cause(s)	Actions to consider/avoid
Insufficient volume contained in the grout box	Place more material in front of the paver; consider using a spreader.
The concrete is stiffening in the grout box	Check for premature concrete stiffening (admixture compatibility). (See No. 2: Loss of workability/slump loss/early stiffening.)
The fine/coarse aggregate volume or paste volume is too low	Check mixture proportions, particularly aggregate gradations. Check the uniformity of aggregate materials/supplies.
The finishing pan angle needs adjustment	Adjust the pan angle.
The paver speed is too high or vibrators need to be adjusted	Slow the paver.
	Lower the vibrator frequencies or use vibrators with greater force.
	Adjust the location of the vibrators; raise them closer to the surface.
	Place more material in front of the paver; consider using a spreader.
	Change the vibrator angle.

13. Concrete tears through paving machine

Potential cause(s)	Actions to consider/avoid
Excessive concrete slump loss	Check for slump loss and mixture or weather changes.
	See No. 2: Loss of workability/slump loss/early stiffening.
Insufficient concrete slump	Check the mixture proportions.
Angular fine aggregate (manufactured sand)	Replace a portion of the manufactured sand with natural sand.
Paver speed too high	Slow the paver.
Coarse aggregate is segregated	Check the stockpile.
Coarse aggregate is gap-graded	Check the combined aggregate grading.
	Blend the aggregate with intermediate aggregates to achieve a uniform combined grading.

14. Paving leaves vibrator trails

Potential cause(s)	Actions to consider/avoid
Vibrator frequency too low	Check if the seals on the vibrators are leaking.
Vibrator frequency too high	Lower the vibrator frequency.
Paver speed too slow	Increase the paver speed.
Nonworkable concrete mix	Review concrete workability field test data.
	See No. 2: Loss of workability/slump loss/early stiffening.
Oversanded mixes	Increase the coarse aggregate.
Poor combined aggregate grading	Check the combined aggregate grading.

15. Slab edge slump

Potential cause(s)	Actions to consider/avoid
Poor and/or nonuniform concrete (gap-graded aggregate, high water/cement ratio, etc.)	Verify the mix design and batching procedures.
	Check the aggregate grading—use a well-graded combined aggregate gradation.
Inadequate operation of equipment	Check the construction procedures.
	Adjust the outside vibrator frequency.
	Adjust the side form batter.
Improper equipment setup	Adjust the overbuild.
	Check the track speed (same on both sides).
	Check the pan profile.

16. Honeycombed slab surface or edges

Potential cause(s)	Actions to consider/avoid
Hot weather may induce premature stiffening	Follow hot-weather concreting practices if appropriate.
	See No. 2: Loss of workability/slump loss/early stiffening.
Inadequate vibration	Check that all vibrators are working properly, at the right frequency and amplitude; the paver speed should not be too high.
	Add an additional vibrator near the slipformed edge.
Poor workability	Check for changes in the aggregate grading.

17. Plastic shrinkage cracks

Potential cause(s)	Actions to consider/avoid
High evaporation rate (excessive loss of moisture from surface of fresh concrete; i.e., evaporation rate > bleed rate)	Apply the curing compound as soon as possible to protect the concrete from loss of moisture.
	Use additional curing measures: fogging, evaporation retarder, windbreaks, shading, plastic sheets, or wet coverings.
	Make sure the absorptive aggregates are kept moist; a dry concrete mixture from concrete aggregates that are not saturated tends to surface dry at mixing. This is problematic if not accounted for.
	Use a well-graded combined aggregate (gap gradation requires more paste and causes more shrinkage).
	Refer to hot-weather concreting practices if appropriate.
	Pave at night.
	Chill the mixing water.
	Dampen the subgrade.
	Avoid paving on hot, windy days.
	Consider adding fibers to the mix.
Delayed setting time	Check the time of set.

After the Concrete Has Set

Other problems, such as rapid stiffening, may be observed only after the concrete has been placed. In such cases, the material may have to be removed, or it may be accepted as long as future deliveries are corrected.

In the First Days after Placing

Some problems, such as early-age cracking, are observed at some time between final set and up to a few days after placing (Table 10-2). Some remedial work may be possible (and required), and steps should be taken to prevent their recurrence.

Table 10-2. Problems observed in the first days after placing

Strength

18. Strength gain is slow

Potential cause(s)	Actions to consider/avoid
Cold temperature during/after placement	Heat the mix water.
	Use burlap/insulating blankets for protection from freezing.
	Use an accelerating admixture.
	Eliminate/reduce GGBF slag and fly ash content in the mix.
	Increase the cement content.
	Use a Type III cement.
	Utilize early-entry sawing to reduce the potential for random cracking.
Mix proportions or materials have changed	Monitor the slab temperature with maturity sensors.
	Check/monitor the moisture contents of the aggregate stockpiles.
	Check for uniformity of the cementitious materials.
	Check the batch weigh scales.
	Verify that aggregate gradations are correct.
	Verify that batch weights are consistent with the mix design.

19. Strength is too low

Potential cause(s)	Actions to consider/avoid
Cementitious materials	Check for changes in the cementitious materials.
	Check that the correct materials have been loaded into the cement/fly ash/slag silos.
Water	Check the water content.
	Verify the aggregate moisture contents and batch weights.
Change in sand grading	Check the sand stockpile to see whether the grading has changed.
Contamination with organics	Contamination of one of the ingredients with organics can also effect a sudden change in the required dosage of air-entraining admixture; try to isolate the source.
Inadequate or variable mixing	Examine the mixer and mixing procedures.
	Check for worn mixer blades.
	Check for mixer overloading.
	Batch smaller loads.
	Check the sequencing of batching.
	Check for mixing time consistency.
Plant operations	Conduct batch plant uniformity testing.
	Verify the acceptability of the batching and mixing process.
	Check for adequate mixing times.
Testing procedures	Check if water was added to the truck.
	Verify proper making, curing, handling, and testing of strength specimens. (Flexural strength specimens are particularly vulnerable to poor handling and testing procedures.)
	Verify the machine acceptability testing.
Air-void clustering	Test the cores sampled from the pavement to verify acceptance.
	Use a Vinsol resin-based air-entraining admixture.
	Avoid retempering.
	Increase the mixing time.

Cracking

20. Early-age cracking

Potential cause(s)	Actions to consider/avoid
Concrete mixture	Check the combined aggregate grading.
	Examine the fine aggregates; fine aggregates may be too fine and angularity may cause harsh finishing (i.e., manufactured sands).
	Reduce the paste content (minimize shrinkage potential).
	Materials incompatibility may lead to delayed set and/or higher concrete shrinkage; consider mixture component adjustments.
	Eliminate or reduce the content of fly ash or GGBF slag in cool-weather conditions.
Sawing	Consider using an accelerator in cold weather.
	Saw as early as possible but avoid excessive raveling.
	Saw in the direction of the wind.
	Check that the diamond saw blade is appropriate for concrete aggregate hardness, fines, etc.
	Use early-entry dry sawing.
Curing	Use HIPERPAV to model stress versus strength gain for conditions to determine the optimum sawing time.
	Improve/extend curing.
	Apply the curing compound at a higher rate.
Insufficient joint depth	Apply the curing compound sooner.
	Use blankets between placing and saw-cutting.
	Check the saws for depth setting.
	Check the saw blade for wear (carbide blades).
Excessive joint spacing	Check that saw operators are not pushing saws too fast, causing them to ride up.
	Look for base bonding or mortar penetration into the open-graded base-altered effective section; increase the saw depth to create an effective weakened plane.
	Check the slab thickness.
	Reduce spacing between the joints.
Warping (slab curvature due to moisture gradient; the term "curling," however, is commonly used in the industry to cover both moisture- and temperature-related slab distortion)	Slabs are too wide in relation to thickness and length; add intermediate joints.
	Maintain a reasonable length-width ratio.
	Check the moisture state of base.
	Improve or extend curing.
	Minimize the shrinkage potential of the concrete mixture.
	Cover the slab, particularly when night/day temperatures vary widely.

(continued on the following page)

20. Early-age cracking, continued

Potential cause(s)	Actions to consider/avoid
High temperature	Cool the raw materials before mixing the concrete: shade, spray, ice, liquid nitrogen
	Cool the equipment.
	Work at night.
	Watch for shaded areas where drying and strength gain may vary within a single day's work.
	Delay paving if conditions are too hot (100°F).
	Apply an evaporative retardant prior to texturing.
	Apply the curing compound at an additional dosage rate and consider a non-water-based compound with better membrane-forming solids.
Too many lanes tied together (generally only a consideration for longitudinal direction)	Do not exceed 50 ft of pavement tied together.
	Add an untied construction or isolation joint.
	To prevent additional cracking, consider sawing through a longitudinal joint to sever bars.
Edge restraint (paving against an existing or previously placed lane)	Cracks occur due to restraint to movement (sometimes referred to as sympathy cracks).
	Tool the joint or use an early-entry dry saw to form the joints as early as possible.
	Match the joint location and type.
	Eliminate tiebars in a longitudinal construction joint that is within 24 in. on either side of transverse joint locations. Match all locations of the joints in the existing pavement (cracks, too).
Slab/base bonding or high frictional restraint	Moisten the base course prior to paving (reduce the base temperature by evaporative cooling).
	Use a bond-breaking medium (see reflective cracks).
	If the base is open graded, use a choker stone to prevent the penetration of concrete into the base's surface voids.
Misaligned dowel bars	Investigate whether the joints surrounding the crack have activated and are functioning; misaligned or bonded dowels may prevent joint functioning, causing cracks.
Cold front with or without rain shower	Use early-entry sawing to create a weakened plane prior to temperature contraction.
	Skip-saw (saw every other joint or every third joint) until normal sawing can be resumed.
	Use HIPERPAV to model stress versus strength-gain conditions that may warrant a suspension or change of paving activities.

Joint issues

21. Raveling along joints

Potential cause(s)	Actions to consider/avoid
Sawing too soon	Wait longer to saw.
	Blank out transverse tining at transverse contraction joints.
Saw equipment problem	Blade selection for the concrete (coarse aggregate type) may be inadequate.
	A bent arbor on the saw causes the blade to wobble.
Sawing too fast	The second saw cut can go back and forth; consider a single-cut design.
	Slow down.

22. Spalling along joints

Potential cause(s)	Actions to consider/avoid
Excessive hand finishing	Check for mixture problems that would necessitate overfinishing.
	Improve construction practice.
Trying to fix edge slump of low spots by hand manipulating concrete	Check for mixture problems that would cause edge slump.
	Improve construction practice.
Mortar penetration into transverse joints (after hardening mortar prevents joint closure)	Mortar penetration occurs when paving against an existing previously placed lane; apply duct tape or other means to block the penetration of mortar into the transverse joints of the existing lane.
Collateral damage from equipment, slipform paver tracks, screeds, etc.	Protect the edges of the slab from damage using gravel or dirt ramps.
	Delay placement of the next phase of construction until the concrete gains sufficient strength.

23. Dowels are out of alignment

Potential cause(s)	Actions to consider/avoid
Movement in dowel basket assemblies	Cover the dowel baskets with concrete ahead of the paver.
	Use stakes to secure the baskets to the granular base.
	Increase the length and number of stakes.
	Use nailing clips on both sides of basket to secure the basket to the stabilized base.
Dumping directly on dowel baskets	Deposit the concrete a few feet from the dowel basket to allow the concrete to flow around the dowel bars.
Poor aggregate gradation	Dowel insertion into mixtures with gap-graded aggregates does not work well; improve the aggregate grading.

Some Time after Construction

Finally, some problems are observed only after the pavement has been in place for some time (Table 10-3).

In these cases, some repair may be possible or replacement may be required. Table 10-3 provides guidelines on how to prevent such problems in future construction.

Table 10-3. Preventing problems that are observed some time after construction

Edge and surface issues

24. Clay balls appear at pavement surface

Potential cause(s)	Actions to consider/avoid
Aggregate stockpile contamination generally caused by the following: <ul style="list-style-type: none"> • Haul trucks tracking clay and mud to stockpiles • Loader operator digging into dirt • Dirt coming from the quarry 	Educate the loader operator on proper stockpile management techniques.
	Keep end-loader buckets a minimum of 2 ft off the ground.
	Do not stockpile aggregates on soft foundations.
	Stabilize the haul road at the plant site to avoid tracking contaminants.
	Use belt placers at stockpiles rather than end loaders.
	Check the aggregate producer's stockpiles.
	Check for contamination in the hauling equipment.
	Do not drive over a bridge to unload the aggregate.
Mud being thrown into concrete trucks from muddy haul roads	Cover the trucks.

25. Popouts

Potential cause(s)	Actions to consider/avoid
Unsound aggregates	Use only aggregates that have been tested for chert, shale, and/or other undesirable fine particles.
	Reduce vibration to minimize the flotation of particles.
Alkali-silica reactions (ASRs)	Use non-alkali silica reactive aggregates.
	Use blended cements or supplementary cementitious materials (SCMs) proven to control ASR.

26. Scaled surface

Potential cause(s)	Actions to consider/avoid
Premature finishing	Improve the finishing technique.
Improper finishing	Do not add water to the surface during finishing.
Overfinishing	Improve the finishing technique.
Frost related	Protect the concrete from freezing until a sufficient strength is achieved.
	Concrete damaged by freezing must be removed and replaced.
	Check the air content and spacing factor in the hardened concrete.
	Premature salting; salts should not be applied to immature concrete.
	Check the deicing salts being used.

27. Dusting along surface

Potential cause(s)	Actions to consider/avoid
Adding water during finishing or finishing in bleed water	Prevent the addition of water during finishing.
	Delay finishing until after the dissipation of the bleed water.

Edge and surface issues, continued

28. Concrete blisters

Potential cause(s)	Actions to consider/avoid
Premature closing of surface	Check for bleed water trapping.
	Consider using a double burlap drag to open the surface.
Extremely high/variable air content	Check for the consistency of the air content.
Vibrators too low	Check the vibrator depth.
Vibrator frequency too high	Reduce the vibrator frequency.
Oversanded mixes	Increase the coarse aggregate.
Poor combined aggregate grading (gap grading)	Check the combined aggregate grading.

29. Surface bumps and rough riding pavement

Potential cause(s)	Actions to consider/avoid
Placement operations	Construct and maintain a smooth and stable paver track line.
	Check the string line tension and profile.
	Maintain a consistent quantity of concrete in front of the paver.
	Maintain a consistent forward motion; avoid a stop-and-go operation.
	Check the paver tracks.
	Check that the machine is level.
	Check the sensors on the paver.
Nonuniform concrete	Verify that the paver electronics/hydraulics are functioning properly.
	Check the batching, mixing, and transport procedures for consistency.
Damping or rebound from dowel baskets	Check the aggregate grading and moisture contents for variations that might lead to wet and dry batches.
	Lack of consolidation to achieve a uniform concrete density within the dowel basket area may create a rough surface because the concrete may settle or slough over the dowels.
	Check that the dowel baskets are secured.
	The basket assembly deflects and rebounds after the slipform paver profile pan passes overhead and the extrusion pressure is released. The result is a slight hump in the concrete surface just ahead of the basket. Spring-back is more apt to occur on steeper grades and when there is too much draft in the pan; do not cut the basket spacer wires to prevent the basket from springing under the paver's extrusion pressure.
	Do not overvibrate the concrete at the baskets in an effort to prevent basket movement.

(continued on the following page)

29. Surface bumps and rough riding pavement, continued

Potential cause(s)	Actions to consider/avoid
Reinforcement ripple	Address reinforcement ripple issues with well-graded aggregates and uniform concrete; consolidation is achieved at lower vibration energy and extrusion pressure.
	Reinforcement ripple occurs when plastic concrete is restrained by the reinforcing bars, resulting in a ripple in the surface, with the surface slightly lower near each bar than in the area between the bars.
	Longitudinal depressions are caused when longitudinal bars limit the restitution of the surface level behind the profile pan by restraining the rebound of the concrete beneath the bars.
	Transverse ripple is caused by the transverse bars in the same way as longitudinal depressions, except that transverse ripple is found to be less noticeable than the prominent ridge caused by the damming effect of the transverse bars upon the upsurge flow of concrete behind the profile pan.
	The prominence of surface rippling depends on the finishing techniques and depth of cover to the reinforcement, with less cover producing more prominent rippling.
Vertical grades (exceeding 3 percent)	Lower the slump of the concrete; the need to make an adjustment depends upon whether it is difficult to maintain a uniform head of concrete in front of the paver.
	Adjust the profile pan attitude, draft, or angle of attack. (When paving up a steeper grade, the pan elevation may be adjusted to about 1.0 in. below the surface grade. When paving down a steeper slope, the pan may be adjusted to about 1.0 in. above the surface grade. This adjustment must be made carefully to avoid reinforcement ripple, particularly a spring-back of the embedded dowel baskets.)
	Adjust the staking interval; closely follow the grade and staking calculations for these circumstances to reduce the semi-chord effect enough to produce a smooth surface.

30. Surface is marred or mortar is worn away

Potential cause(s)	Actions to consider/avoid
Rained-on surface	Cover the slab to protect from rain.
	Remove the damaged surface by grinding.
	Restore the surface texture (if required) by grinding.
Improper curing type or application	Place a curing blanket or plastic sheets after the bleed water sheen disappears.
	Consider using a membrane-forming curing compound instead of sheets/blankets.
Use of higher dosages (>25%) of GGBF slag	Do not add water to the mixture.
	Reduce the vibration energy to avoid bringing too much moisture to the surface; vibration at 5,000–8,000 vpm is sufficient for most well-graded mixtures.
Oversanded mixes	Increase the coarse aggregate.
Abrasion	Use a hard, wear-resistant aggregate.
	Use a concrete mix with sufficient strength.

Cracking

31. Cracking

Potential cause(s)	Actions to consider/avoid
Applied loads	Keep construction traffic away from the slab edges; early loading by traffic or equipment causes higher edge stresses.
	Keep public traffic away from the slab edges.
Loss of support	Ensure that the subgrade and base have been properly prepared.
	Ensure that the joints are properly filled and sealed where appropriate.
Reflective cracks from stabilized bases	Isolate the slab from cracks in the base course by using bond breakers. (Acceptable bond breakers include two coats of wax-based curing compound, dusting of sand, bladed fines, asphalt emulsion, polyethylene sheets, and tar paper. Sheet goods are difficult to handle in windy or other harsh conditions.)
Slab/base bonding or high frictional restraint	Moisten the base course prior to paving (reduce the base temperature by evaporative cooling).
	Use a bond-breaking medium (see "Reflective cracks from stabilized bases," immediately above)
	If the base is open-graded, use a choker stone to prevent the penetration of concrete into the base's surface voids.
Mortar penetration into transverse joints (after hardening mortar prevents joint closure)	Mortar penetration occurs when paving against an existing previously placed lane; apply duct tape or other means to block the penetration of mortar into the transverse joints of the existing lane.
Differential support condition created by frost heaving, soil settling, or expansive soils	Check base compaction, particularly above utility, culvert, and other trenches.
	Proof roll the base.
	Stabilize the subgrade soil.
	Use selective grading techniques; cross-haul the soils to create smooth transitions between cut and fill sections and soil transitions.
Misaligned dowel bars	Investigate whether the joints surrounding the crack have cracked and are functioning; misaligned or bonded dowels may prevent joint functioning, causing cracks.
	Designate personnel to ensure dowel alignment.
Alkali-silica reactions	Avoid using reactive aggregates if possible.
	Use appropriate amounts of SCMs.
	Use blended cements or SCMs proven to control ASR.
Chemical attack	Use a low water/cementitious materials (w/cm) ratio.
	Use a low w/cm ratio, maximum 0.45.
	Use an appropriate cementitious system for the environment.
Frost related	Ensure that the air-void system of the in-place concrete is adequate.
	Use a low w/cm ratio.
	Use frost-resistant aggregates.
	Reduce the maximum particle size.

Table 10-4 is a listing of some of the nondestructive testing (NDT) techniques available to assess the extent of damage in hardened concrete.

Table 10-4. Assessing the extent of damage in hardened concrete

Problem	Nondestructive Testing Method(s)
1. Dowel bar alignment	Twin antenna radar
	Pulse induction (MIT-DOWEL-SCAN)
2. Pavement thickness	Impact-echo, radar
3. Pavement subgrade support and voiding	Impulse response
	Benkelman beam
	Falling weight deflectometer (FWD)
4. Concrete quality in pavement: a) Inclusions in pavement (clay balls) b) Honeycombing and poor concrete consolidation	Impulse radar
	Impulse response
5. Overlay debonding and separation: a) Traditional b) Advanced techniques	Hammer sounding
	Chain drag
	Impulse response
	Impact-echo, radar
6. Concrete strength	Rebound hammer (for comparative tests)
	Windsor probe

References

Harrington, D., M. Ayers, T. Cackler, G. Fick, D. Schwartz, K. Smith, M. Snyder, and T. Van Dam. 2018. *Guide for Concrete Distress Assessments and Solutions: Identification, Causes, Prevention, and Repair*. National Concrete Pavement Technology Center, Ames, IA.

Glossary

A

AASHTO

American Association of State Highway and Transportation Officials.

Absolute Specific Gravity

The ratio of the weight in a vacuum of a given volume of material at a stated temperature to the weight in a vacuum of an equal volume of gas-free distilled water at the same temperature.

Absolute Volume (of Concrete or Mortar Ingredients)

The displacement volume of a concrete or mortar ingredient; in the case of solids, the volume of the particles themselves, including their permeable or impermeable voids but excluding space between particles; in the case of fluids, the volume that they occupy.

Absorbed Moisture

The moisture held in a material and having physical properties not substantially different from those of ordinary water at the same temperature and pressure.

Absorption

The amount of water absorbed under specific conditions, usually expressed as a percentage of the dry weight of the material; the process by which water is absorbed.

Acceleration

Increase in rate of hardening or strength development of concrete.

Accelerator

An admixture that when added to concrete, mortar, or grout increases the rate of hydration of hydraulic cement, shortens the time to set, or increases the rate of hardening or strength development.

ACI

American Concrete Institute.

ACPA

American Concrete Pavement Association.

ACR

Alkali-carbonate reaction.

Admixture

A material other than water, aggregates, and portland cement (including air-entraining portland cement and portland blast-furnace slag cement) that is used as an ingredient of concrete and is added to the batch before and/or during the mixing operation.

Adsorbed Water

Water held on surfaces of a material by physical and chemical forces and having physical properties substantially different from those of absorbed water or chemically combined water at the same temperature and pressure.

Aggregate

Granular material, such as sand, gravel, crushed stone, crushed hydraulic-cement concrete, or iron blast furnace slag, used with a hydraulic cementing medium to produce either concrete or mortar.

Aggregate Blending

The process of intermixing two or more aggregates to produce a different set of properties (generally, but not exclusively, to improve grading).

Aggregate Gradation

The distribution of particles of granular material among various sizes, usually expressed in terms of cumulative percentages larger or smaller than each of a series of sizes (sieve openings) or the percentages between certain ranges of sizes (sieve openings). See also *Grading*.

Aggregate Interlock

The projection of aggregate particles or portion of aggregate particles from one side of a joint or crack in concrete into recesses in the other side of the joint or crack so as to effect load transfer in compression and shear and maintain mutual alignment.

Aggregate, Angular

Aggregate particles that possess well-defined edges formed at the intersection of roughly planar faces.

Aggregate, Coarse

Aggregate predominantly retained on the #4 sieve or the portion of an aggregate retained on the #4 sieve.

Aggregate, Dense-Graded

Aggregates graded to produce low void content and maximum weight when compacted.

Aggregate, Fine

Aggregate passing the $\frac{3}{8}$ in. sieve and almost entirely passing the #4 sieve and predominantly retained on the #200 sieve.

Aggregate, Gap-Graded

Aggregate so graded that certain intermediate sizes are substantially absent.

Aggregate, Maximum Size of

The largest-size aggregate particles present in sufficient quantity to affect properties of a concrete mixture.

Aggregate, Open-Graded

Concrete aggregate in which the voids are relatively large when the aggregate is compacted.

Aggregate, Well-Graded

Aggregate having a particle size distribution that will produce maximum density; i.e., minimum void space.

Agitating Truck

A vehicle in which freshly mixed concrete can be conveyed from the point of mixing to that of placing; while being agitated, the truck body can either be stationary and contain an agitator or it can be a drum rotated continuously so as to agitate the contents.

Agitation

The process of providing gentle motion in mixed concrete just sufficient to prevent segregation or loss of plasticity.

Air Content

The amount of air in mortar or concrete, exclusive of pore space in the aggregate particles, usually expressed as a percentage of the total volume of mortar or concrete.

Air Void

A space in cement paste, mortar, or concrete filled with air; an entrapped air void is characteristically 0.04 in. or more in size and irregular in shape; an entrained air void is typically between 0.00040 in. and 0.04 in. in diameter and spherical (or nearly so).

Air Entraining

The capabilities of a material or process to develop a system of minute bubbles of air in cement paste, mortar, or concrete during mixing.

Air-Entraining Agent

An addition for hydraulic cement or an admixture for concrete or mortar that causes air, usually in small quantities, to be incorporated in the form of minute bubbles in the concrete or mortar during mixing, usually to increase its workability and frost resistance.

Air-Entraining Cement

A cement that has an air-entraining agenda added during the grinding phase of manufacturing.

Air Entrainment

The inclusion of air in the form of minute bubbles during the mixing of concrete or mortar.

Albedo

Solar reflectance, which is a measure of the ability of a surface to reflect solar radiation, is the single most important pavement material property affecting thermal performance. Albedo is measured on a scale of 0 (perfectly absorptive) to 1 (perfectly reflective). Concrete typically has an albedo between 0.2 and 0.5, depending on constituent materials and age.

Alkali-Aggregate Reaction

Chemical reaction in mortar or concrete between the alkalis (sodium and potassium) released from portland cement or other sources and certain compounds present in the aggregates; under certain conditions, harmful expansion of the concrete or mortar may be produced.

Alkali-Carbonate Reaction

The reaction between the alkalis (sodium and potassium) in portland cement binder and certain carbonate rocks, particularly calcite dolomite and dolomitic limestones, present in some aggregates; the products of the reaction may cause abnormal expansion and cracking of concrete in service.

Alkali-Silica Reaction

The reaction between the alkalis (sodium and potassium) in portland cement binder and certain siliceous rocks or minerals (such as opaline chert, strained quartz, or acidic volcanic glass) that are present in some aggregates; the products of the reaction may cause abnormal expansion and cracking of concrete in service.

Angular Aggregate

See *Aggregate, Angular*.

Artificial Turf Drag Surface

Surface texture achieved by inverting a section of artificial turf that is attached to a device that allows control of the time and rate of texturing.

Asphalt

A brown-to-black bituminous substance that is chiefly obtained as a residue of petroleum refining and that consists mostly of hydrocarbons.

ASR

See *Alkali-Silica Reaction*.

ASTM

American Society for Testing and Materials.

B**Backer Rod**

Foam cord inserted into a joint sealant reservoir and used to shape a liquid joint sealant and prevent sealant from adhering to or flowing out of the bottom of the reservoir.

Bag (of cement)

A quantity of portland or air-entraining portland cement (or other type of cement indicated on the bag) that is 42.6 kg in the United States and 39.7 kg in Canada.

Ball Test

A test to determine the consistency of fresh concrete by measuring the depth of penetration via a steel ball that is usually called a Kelly ball.

Bar

A member used to reinforce concrete, usually made of steel.

Barrel (of cement)

A unit of weight for cement equivalent to four bags of portland or air-entraining portland cements (totaling 170.6 kg net in the United States and 158.8 kg net in Canada) or for other kinds of cement, as defined by the manufacturer.

Base

The underlying stratum on which a concrete slab, such as a pavement, is placed.

Base Course

A layer of specified select material of planned thickness constructed on the subgrade or subbase below a pavement to serve one or more functions such as distributing loads, providing drainage, minimizing frost action, or facilitating pavement construction.

Batch

Quantity of concrete or mortar mixed at one time.

Batch Plant

Equipment used for batching concrete materials.

Batch Weights

The weights of the various materials (cement, water, the several sizes of aggregate, and admixtures) that compose a batch of concrete.

Batched Water

The mixing water added to a concrete or mortar mixture before or during the initial stages of mixing.

Batching

Weighing or volumetrically measuring and introducing into the mixer the ingredients for a batch of concrete or mortar.

Beam Test

A method of measuring the flexural strength (modulus of rupture) of concrete by testing a standard unreinforced beam.

Binder

See *Cement Paste*.

Blast-Furnace Slag

The nonmetallic byproduct, consisting essentially of silicates and aluminosilicates of lime and other bases, that is produced in a molten condition simultaneously with iron in a blast furnace.

Bleeding

The self-generated flow of mixing water within, or its emergence from, freshly placed concrete or mortar.

Bleeding Rate

The rate at which water is released from a paste or mortar by bleeding, usually expressed as cubic centimeters of water released each second from each square centimeter of surface.

Blended Cement

See *Cement, Blended*.

Blended Hydraulic Cement

See *Cement, Blended*.

Blistering

The irregular rising of a thin layer of placed mortar or concrete at the surface during or soon after completion of the finished operation.

Bond

The adhesion of concrete or mortar to reinforcement or other surfaces against which it is placed; the adhesion of cement paste to aggregate.

Bond Area

The interface area between two elements across which adhesion develops or may develop, as between concrete and reinforcing steel.

Bond Breaker

A material used to prevent adhesion of newly placed concrete from other material, such as a substrate.

Bond Hardness

The support (bond strength) that the metal matrix in a diamond-saw-blade segment provides to each diamond that is embedded within the matrix.

Bond Strength

Resistance to separation of mortar and concrete from reinforcing steel and other materials with which it is in contact; a collective expression for all forces such as adhesion, friction due to shrinkage, and longitudinal shear in the concrete engaged by the bar deformations that resist separation.

Bond Stress

The force of adhesion per unit area of contact between two surfaces such as concrete and reinforcing steel or any other material such as foundation rock.

Bonded Concrete Overlay

Thin (2 to 4 in.) layer of new concrete placed onto a slightly deteriorated existing concrete pavement with steps taken to prepare the old surface to promote the adherence of the new concrete.

Bonding Agent

A substance applied to an existing surface to create a bond between it and a succeeding layer, as between a bonded overlay and existing concrete pavement.

Broom

The surface texture obtained by stroking a broom over freshly placed concrete. A sandy texture obtained by brushing the surface of freshly placed or slightly hardened concrete with a stiff broom.

Bulk Cement

Cement that is transported and delivered in bulk (usually in specially constructed vehicles) instead of in bags.

Bulk Density

The mass of a material (including solid particles and any contained water) per unit volume, including voids.

Bulk Specific Gravity

The ratio of the weight in air of a given volume of a permeable material (including both permeable and impermeable voids normal to the material) at a stated temperature to the weight in air of an equal volume of distilled water at the same temperature.

Bulking Factor

Ratio of the volume of moist sand to the volume of the sand when dry.

Bull Float

A tool comprising a large, flat, rectangular piece of wood, aluminum, or magnesium usually 8 in. wide and 39 to 60 in. long and a handle 1.1 to 5.5 yd long used to smooth unformed surfaces of freshly placed concrete.

Burlap

A coarse fabric of jute, hemp, or less commonly flax, for use as a water-retaining cover for curing concrete surfaces (also called Hessian).

Burlap Drag

Surface texture achieved by trailing moistened coarse burlap from a device that allows control of the time and rate of texturing.

C**Calcareous**

Containing calcium carbonate, or less generally, containing the element calcium.

Calcium Chloride

A crystalline solid, CaCl_2 ; in various technical grades, used as a drying agent, as an accelerator of concrete, a deicing chemical, and for other purposes.

Calcium Lignosulfonate

An admixture, refined from papermaking wastes, employed in concrete to retard the set of cement, reduce water requirement and increase strength.

California Bearing Ratio

The ratio of the force per unit area required to penetrate a soil mass with a 7.6 in.² circular piston at the rate of 0.05 in. per min to the force required for corresponding penetration of a standard crushed-rock base material; the ratio is usually determined at 0.10 in. penetration.

California Profilograph

Rolling straightedge tool used for evaluating a pavement profile (smoothness) consisting of a 25 ft frame with a sensing wheel located at the center of the frame that senses and records bumps and dips on graph paper or in a computer.

Capillary

In cement paste, any space not occupied by unhydrated cement or cement gel (air bubbles, whether entrained or entrapped, are not considered to be part of the cement paste).

Capillary Absorption

The action of surface tension forces that draws water into capillaries (i.e., in concrete) without appreciable external pressures.

Capillary Flow

Flow of moisture through a capillary pore system, such as concrete.

Capillary Space

In cement paste, any space not occupied by anhydrous cement or cement gel. (Air bubbles, whether entrained or entrapped, are not considered to be part of the cement paste.)

Carbonation

Reaction between carbon dioxide and the products of portland cement hydration to produce calcium carbonate.

Cast-in-Place Concrete

See *Concrete, Cast-in-Place*.

Cement

See *Portland Cement*.

Cement Content

Quantity of cement contained in a unit volume of concrete or mortar, ordinarily expressed as pounds, barrels, or bags per cubic yard.

Cement Factor

See *Cement Content*.

Cement Paste

Constituent of concrete consisting of cement and water.

Cement, Blended

A hydraulic cement made of portland cement that is uniformly mixed with slag cement, pozzolan, or both.

Cement, Expansive

A special cement that when mixed with water forms a paste tending to increase in volume at an early age; used to compensate for volume decrease due to drying shrinkage.

Cement, High Early-Strength

Cement characterized by producing earlier strength in mortar or concrete than regular cement, referred to in the United States as Type III.

Cement, Hydraulic

A cement such as normal portland cement that is capable of setting and hardening under water due to the chemical interaction of the water and the constituents of the cement.

Cement, Normal

General purpose portland cement, referred to in the United States as Type I.

Cement, Portland-Pozzolan

A hydraulic cement consisting essentially of an intimate and uniform blend of portland cement or portland blast-furnace slag cement and fine pozzolan produced by intergrinding portland cement clinker with pozzolan, by blending portland cement or portland blast-furnace slag cement with finely divided pozzolan, or a combination of intergrinding and blending, in which the pozzolan constituent is within specified limits.

Cement/Aggregate Ratio

The ratio, by weight or volume, of cement to aggregate.

Cementitious Materials

Substances that alone have hydraulic cementing properties (i.e., set and harden in the presence of water); includes ground granulated blast furnace slag, natural cement, hydraulic hydrated lime, and combinations of these and other materials.

Central Mixer

A stationary concrete mixer from which the fresh concrete is transported to the work.

Central-Mixed Concrete

See *Concrete, Central-Mixed*.

Chalking

A phenomenon of coatings, such as cement paint, manifested by the formation of a loose powder by deterioration of the paint at or just beneath the surface.

Coarse Aggregate

See *Aggregate, Coarse*.

Coefficient of Thermal Expansion

Change in linear dimension per unit length or change in volume per unit volume per degree of temperature change.

Cohesion Loss

The loss of internal bond within a joint sealant material, indicated by a noticeable tear along the surface and through the depth of the sealant.

Cohesiveness

The property of a concrete mix that enables the aggregate particles and cement paste matrix therein to remain in contact with each other during mixing, handling, and placing operations; the “stick-togetherness” of the concrete at a given slump.

Combined Aggregate Grading

Particle size distribution of a mixture of fine and coarse aggregate.

Compaction

The process whereby the volume of freshly placed mortar or concrete is reduced to the minimum practical space, usually by vibration, centrifugation, tamping, or some combination of these; to mold it within forms or molds and around embedded parts and reinforcement, and to eliminate voids other than entrained air. See also *Consolidation*.

Compression Test

Test made on a specimen of mortar or concrete to determine the compressive strength; in the United States, unless otherwise specified, compression tests of mortars are made on 2 in. cubes, and compression tests of concrete are made on cylinders 6 in. in diameter and 12 in. high.

Compressive Strength

The measured resistance of a concrete or mortar specimen to axial loading, expressed as pounds per square inch (psi) of cross-sectional area.

Concrete

A mixture of hydraulic cement, aggregates, and water that may or may not also include admixtures, fibers, and/or other cementitious materials.

Concrete, Cast-in-Place

Concrete placed and finished in its final location.

Concrete, Central-Mixed

Concrete that is completely mixed in a stationary mixer from which it is transported to the delivery point.

Concrete Spreader

A machine designed to spread concrete from heaps already dumped in front of it or to receive and spread concrete in a uniform layer.

Concrete, Normal-Weight

Concrete having a unit weight of approximately 2,400 kg/m³ made with aggregates of normal weight.

Concrete, Reinforced

Concrete construction that contains mesh or steel bars embedded in it.

Consistency

The relative mobility or ability of fresh concrete or mortar to flow. The usual measures of consistency are slump or ball penetration for concrete and flow for mortar.

Consolidate

Compaction usually accomplished by vibration of newly placed concrete to a minimum practical volume in order to mold it within form shapes or around embedded parts and reinforcement as well as to reduce void content to a practical minimum.

Consolidation

The process of inducing a closer arrangement of the solid particles in freshly mixed concrete or mortar during placement by the reduction of voids, usually by vibration, centrifugation, tamping, or some combination of these actions; also applicable to similar manipulation of other cementitious mixtures, soils, aggregates, or the like. See also *Compaction*.

Construction Joint

The junction of two successive placements of concrete, typically with a keyway or reinforcement across the joint.

Continuously Reinforced Pavement

A pavement with continuous longitudinal steel reinforcement and no intermediate transverse expansion or contraction joints.

Contract

Decrease in length or volume. See also *Expansion*, *Shrinkage*, and *Swelling*.

Contraction

Decrease in length or volume. See also *Expansion*, *Shrinkage*, and *Swelling*.

Contraction Joint

A plane, usually vertical, separating concrete in a structure of pavement at a designated location such as to prevent formation of objectionable shrinkage cracks elsewhere in the concrete. Reinforcing steel is discontinuous.

Control Joint

See *Contraction Joint*.

Coproducts

Materials derived as part of another process (often industrial but possibly agricultural) that bring value to the overall process. For pavement applications, some of the most common coproducts result from the production of pig iron for steel making, including slag cement. In some regional markets, fly ash can be categorized as waste; whereas, in other markets, it is clearly a coproduct because it has economic value beyond the cost of transport and disposal.

Core

A cylindrical specimen of standard diameter drilled from a structure or rock foundation to be tested in compression or examined petrographically.

Corner Break

A portion of the slab separated by a crack that intersects the adjacent transverse or longitudinal joints at about a 45° angle with the direction of traffic. The length of the sides is usually from 1 ft to one-half of the slab width on each side of the crack.

Course

In concrete construction, a horizontal layer of concrete, usually one of several making up a lift; in masonry construction, a horizontal layer of block or brick. See also *Lift*.

CPCD

Concrete pavement contraction design; term used in Texas for jointed plain concrete pavement (see *Jointed Plain Concrete Pavement*).

Crack Saw

Small three-wheeled specialty saw useful for tracing the wandering nature of a transverse or longitudinal crack; usually contains a pivot wheel and requires a small diameter crack sawing blade.

Cracking

The process of contraction or the reflection of stress in the pavement.

Crazing

Minute surface pattern cracks in mortar or concrete due to unequal shrinkage or contraction on drying or cooling.

CRC Pavement (CRCP)

Continuously reinforced concrete pavement; see *Continuously Reinforced Pavement*.

Cross Section

The section of a body perpendicular to a given axis of the body; a drawing showing such a section.

Crushed Gravel

The product resulting from the artificial crushing of gravel with a specified minimum percentage of fragments having one or more faces resulting from fracture. See also *Aggregate*, *Coarse*.

Crushed Stone

The product resulting from the artificial crushing of rocks, boulders, or large cobblestones, substantially all faces of which possess well-defined edges resulting from the crushing operation.

Crusher-Run Aggregate

Aggregate that has been broken in a mechanical crusher and has not been subjected to any subsequent screening process.

Cubic Yard

Normal commercial units of measure of concrete volume, equal to 27 ft³.

Cure

Maintenance of temperature and humidity for freshly placed concrete during some definite period following placing and finishing to ensure proper hydration of the cement and proper hardening of the concrete.

Curing

The maintenance of a satisfactory moisture content and temperature in concrete during its early stages so that desired properties may develop.

Curing Blanket

A built-up covering of sacks, matting, Hessian, straw, waterproof paper, or other suitable material placed over freshly finished concrete. See also *Burlap*.

Curing Compound

A liquid that can be applied as a coating to the surface of newly placed concrete to retard the loss of water or, in the case of pigmented compounds, also to reflect heat so as to provide an opportunity for the concrete to develop its properties in a favorable temperature and moisture environment. See also *Curing*.

D

Damp

Either moderate absorption or moderate covering of moisture; implies less wetness than that connoted by “wet” and slightly wetter than that connoted by “moist.” See also *Moist* and *Wet*.

Deformed Bar

A reinforcing bar with a manufactured pattern of surface ridges that provide a locking anchorage with surrounding concrete.

Deformed Reinforcement

Metal bars, wire, or fabric with a manufactured pattern of surface ridges that provide a locking anchorage with surrounding concrete.

Dense-Graded Aggregate

See *Aggregate*, *Dense-Graded*.

Density

Mass per unit volume; by common usage in relation to concrete, weight per unit volume, also referred to as *unit weight*.

Density (Dry)

The mass per unit volume of a dry substance at a stated temperature. See also *Specific Gravity*.

Density Control

Control of density of concrete in field construction to ensure that specified values as determined by standard tests are obtained.

Design Strength

Load capacity of a member computed on the basis of allowable stresses assumed in design.

Deterioration

- 1) Physical manifestation of failure (e.g., cracking, delamination, flaking, pitting, scaling, spalling, and staining) caused by environmental or internal autogenous influences on rock and hardened concrete as well as other materials.
- 2) Decomposition of material during either testing or exposure to service. See also *Weathering*.

Diamond Grinding

The process used to remove the upper surface of a concrete pavement in order to remove bumps and restore pavement rideability.

Dispersing Agent

Admixtures capable of increasing the fluidity of pastes, mortar or concretes by reduction of interparticle attraction.

Distress

Physical manifestation of deterioration and distortion in a concrete structure as the result of stress, chemical action, and/or physical action.

Dolomite

A mineral having a specific crystal structure and consisting of calcium carbonate and magnesium carbonate in equivalent chemical amounts (54.27 and 45.73 percent by weight, respectively); a rock containing dolomite as the principal constituent.

Dowel

- 1) A load-transfer device, commonly a plain round steel bar, that extends into two adjoining portions of a concrete construction, as at a joint in a pavement slab, so as to transfer shear loads.
- 2) A deformed reinforcing bar intended to transmit tension, compression, or shear through a construction joint.

Dowel Bar (Dowelbar)

See *Dowel*.

Dowel Bar Retrofit (DBR)

See *Retrofit Dowel Bars*.

Dowel Basket

See *Load-Transfer Assembly*.

Drainage

The interception and removal of water from, on, or under an area or roadway; the process of removing surplus ground or surface water artificially; a general term for gravity flow of liquids in conduits.

Dry Process

In the manufacture of cement, the process in which the raw materials are ground, conveyed, blended, and stored in a dry condition. See also *Wet Process*.

Dry Mix

Concrete, mortar, or plaster mixture, commonly sold in bags, containing all components except water; also a concrete of near-zero slump.

Dry Mixing

Blending of the solid materials for mortar or concrete prior to adding the mixing water.

Drying Shrinkage

Contraction caused by drying.

Durability

The ability of concrete to remain unchanged while in service; resistance to weathering action, chemical attack, and abrasion.

Dynamic Load

A variable load (i.e., not static, such as a moving live load, earthquake, or wind).

Dynamic Loading

Loading from units (particularly machinery) that, by virtue of their movement or vibration, impose stresses in excess of those imposed by their dead load.

E

Early Strength

Strength of concrete developed soon after placement, usually during the first 72 hours.

Early-Entry Dry Saw

Lightweight saw equipped with a blade that does not require water for cooling and that allows sawing concrete sooner than with conventional wet-diamond sawing equipment.

Econcrete

Portland cement concrete designed for a specific application and environment and, in general, making use of local commercially produced aggregates. These aggregates do not necessarily meet conventional quality standards for aggregates used in pavements.

Edge Form

Formwork used to limit the horizontal spread of fresh concrete on flat surfaces, such as pavements or floors.

Edger

A finishing tool used on the edges of fresh concrete to provide a rounded edge.

Efflorescence

Deposit of calcium carbonate (or other salts), usually white in color, appearing upon the surface or found within the near-surface pores of concrete. The salts deposit on concrete upon evaporation of water that carries the dissolved salts through the concrete toward exposed surfaces.

End of Life

The final disposition and subsequent reuse, processing, or recycling of the pavement after it has reached the end of its useful life.

Entrained Air

Round, uniformly distributed, microscopic, noncoalescing air bubbles entrained by the use of air-entraining agents; usually less than 0.04 in. in size.

Entrapped Air

Air in concrete that is not purposely entrained. Entrapped air is generally considered to be large voids (larger than 0.04 in.).

Equivalent Single-Axle Loads (ESALs)

Summation of equivalent 18,000 lb single-axle loads used to combine mixed traffic to design traffic for the design period.

Evaporable Water

Water set in cement paste present in capillaries or held by surface forces; measured as that removable by drying under specified conditions.

Expansion

Increase in length or volume. See also *Contraction*, *Shrinkage*, and *Swelling*.

Expansion Joint

See *Isolation Joint*.

Exposed Aggregate

Surface texture where cement paste is washed away from concrete slab surface to expose durable chip-size aggregates at the riding surface.

Exposed Concrete

Concrete surfaces formed so as to yield an acceptable texture and finish for permanent exposure to view.

External Vibrator

See *Vibration*.

F**False Set**

The rapid development of rigidity in a freshly mixed portland cement paste, mortar, or concrete without the evolution of much heat, which rigidity can be dispelled and plasticity regained by further mixing without addition of water; premature stiffening, hesitation set, early stiffening, and rubber set are terms referring to the same phenomenon, but false set is the preferred designation.

Fast Track

Series of techniques to accelerate concrete pavement construction.

Faulting

Differential vertical displacement of a slab or other member adjacent to a joint or crack.

FHWA

Federal Highway Administration.

Fibrous Concrete

Concrete containing dispersed, randomly oriented fibers.

Field-Cured Cylinders

Test cylinders cured as nearly as practicable in the same manner as the concrete in the structure to indicate when supporting forms may be removed, additional construction loads may be imposed, or the structure may be placed in service.

Final Set

A degree of stiffening of a mixture of cement and water greater than initial set, generally stated as an empirical value indicating the time in hours and minutes required for a cement paste to stiffen sufficiently to resist to an established degree the penetration of a weighted test needle; also applicable to concrete and mortar mixtures with use of suitable test procedures. See also *Initial Set*.

Final Setting Time

The time required for a freshly mixed cement paste, mortar, or concrete to achieve final set. See also *Initial Setting Time*.

Fine Aggregate

See *Aggregate, Fine*.

Finish

The texture of a surface after compacting and finishing operations have been performed.

Finishing

Leveling, smoothing, compacting, and otherwise treating surfaces of fresh or recently placed concrete or mortar to produce desired appearance and service. See also *Float* and *Trowel*.

Finishing Machine

A power-operated machine used to give the desired surface texture to a concrete slab.

Fixed-Form Paving

A type of concrete paving process that involves the use of fixed forms to uniformly control the edge and alignment of the pavement.

Flash Set

The rapid development of rigidity in a freshly mixed portland cement paste, mortar, or concrete, usually with the evolution of considerable heat, which rigidity cannot be dispelled nor can the plasticity be regained by further mixing without addition of water, also referred to as quick set or grab set.

Flexible Pavement

A pavement structure that maintains intimate contact with and distributes loads to the subgrade and depends on aggregate interlock, particle friction, and cohesion for stability; cementing agents, where used, are generally bituminous (asphaltic) materials as contrasted to portland cement in the case of rigid pavement. See also *Rigid Pavement*.

Flexural Strength

A property of a material or structural member that indicates its ability to resist failure in bending. See also *Modulus of Rupture*.

Float

A tool (not a darby) usually of wood, aluminum, or magnesium, used in finishing operations to impart a relatively even but still open texture to an unformed fresh concrete surface.

Float Finish

A rather rough concrete surface texture obtained by finishing with a float.

Floating

Process of using a tool, usually wood, aluminum, or magnesium, in finishing operations to impart a relatively even but still open texture to an unformed fresh concrete surface.

Flow

- 1) Time-dependent irrecoverable deformation. See *Rheology*.
- 2) A measure of the consistency of freshly mixed concrete, mortar, or cement paste in terms of the increase in diameter of a molded, truncated cone specimen after jiggling a specified number of times.

Flow Cone Test

Test that measures the time necessary for a known quantity of grout to completely flow out of and empty a standard-sized cone; usually used in slab stabilization to determine the water quantity necessary for stabilization grout.

Fly Ash

The finely divided residue resulting from the combustion of ground or powdered coal and that is transported from the fire box through the boiler by flue gasses; used as a mineral admixture in concrete mixtures.

Form

A temporary structure or mold for the support of concrete while it is setting and gaining sufficient strength to be self-supporting.

Free Moisture

Moisture having essentially the properties of pure water in bulk; moisture not absorbed by aggregate. See also *Surface Moisture*.

Free Water

See *Free Moisture* and *Surface Moisture*.

Full-Depth Patching

Removing and replacing at least a portion of a concrete slab to the bottom of the concrete, in order to restore areas of deterioration.

Full-Depth Repair

See *Full-Depth Patching*.

G

Gap-Graded Aggregate

See *Aggregate*, *Gap-Graded*.

Gap-Graded Concrete

Concrete containing a gap-graded aggregate.

Gradation

See *Grading*.

Grading

The distribution of particles of granular material among various sizes, usually expressed in terms of cumulative percentages larger or smaller than each of a series of sizes (sieve openings) or the percentages between certain ranges of sizes (sieve openings).

Gravel

Granular material predominantly retained on the #4 sieve and resulting from natural disintegration and abrasion of rock or processing of weakly bound conglomerate.

Greenhouse Gas (GHG)

Any of various gaseous compounds (such as carbon dioxide or methane) that absorb infrared radiation, trap heat in the atmosphere, and contribute to the greenhouse effect.

Green Concrete

Concrete that has set but not appreciably hardened.

Green Sawing

The process of controlling random cracking by sawing uniform joint spacing in early-age concrete without tearing or dislocating the aggregate in the mix.

Grooving

The process used to cut slots into a concrete pavement surface to provide channels for water to escape beneath tires and to promote skid resistance.

Gross Vehicle Load

The weight of a vehicle plus the weight of any load thereon.

Gross Volume (of Concrete Mixers)

In the case of a revolving-drum mixer, the total interior volume of the revolving portion of the mixer drum; in the case of an open-top mixer, the total volume of the trough or pan calculated on the basis that no vertical dimension of the container exceeds twice the radius of the circular section below the axis of the central shaft.

H

Hairline Cracking

Barely visible cracks in a random pattern in an exposed concrete surface that do not extend to the full depth or thickness of the concrete and that are due primarily to drying shrinkage.

Hardening

When portland cement is mixed with enough water to form a paste, the compounds of the cement react with water to form cementitious products that adhere to each other and to the intermixed sand and stone particles and become very hard. As long as moisture is present, the reaction may continue for years, adding continually to the strength of the mixture.

Harsh Mixture

A concrete mixture that lacks desired workability and consistency due to a deficiency of mortar.

Harshness

Deficient workability and cohesiveness caused by insufficient sand or cement or by improperly graded aggregate.

Header

A transverse construction joint installed at the end of a paving operation or other placement interruptions. To a contractor, a header is the location at which paving will resume on the next day.

Heat of Hydration

Heat evolved by chemical reactions of a substance with water, such as that evolved during the setting and hardening of portland cement.

Heavy-Weight Concrete

Concrete in which heavy aggregate is used to increase the density of the concrete; unit weights in the range of 165 to 330 lb/ft³ are attained.

High-Range Water-Reducing Admixture

See *Water-Reducing Admixture (High Range)*.

High Early-Strength Cement

See *Cement, High Early-Strength*.

High Early-Strength Concrete

Concrete that, through the use of high early-strength cement or admixtures, is capable of attaining specified strength at an earlier age than normal concrete.

Honeycomb

Concrete that, due to lack of the proper amount of fines or vibration, contains abundant interconnected large voids or cavities; concrete that contains honeycombs was improperly consolidated.

Horizontal-Axis Mixer

Concrete mixers of the revolving-drum type in which the drum rotates about a horizontal axis.

Hot-Pour Sealant

Joint sealing materials that require heating for installation, usually consisting of a base of asphalt or coal tar.

Hydrated Lime

A dry powder obtained by treating quicklime with sufficient water to convert it to calcium hydroxide.

Hydration

The chemical reaction between cement and water that causes concrete to harden.

Hydraulic Cement

See *Cement, Hydraulic*.

Hydroplaning

To go out of steering control by skimming the surface of a wet road.

I**Inclined-Axis Mixer**

A truck with a revolving drum that rotates about an axis inclined to the bed of the truck chassis.

Incompressibles

Small concrete fragments, stones, sand, or other hard materials that enter a joint sealant, joint reservoir, or other concrete pavement discontinuity.

Initial Set

A degree of stiffening of a mixture of cement and water less than final set, generally stated as an empirical value indicating the time in hours and minutes required for cement paste to stiffen sufficiently to resist to an established degree the penetration of a weighted test needle; also applicable to concrete or mortar with use of suitable test procedures. See also *Final Set*.

Initial Setting Time

The time required for a freshly mixed cement paste to acquire an arbitrary degree of stiffness as determined by a specific test.

Inlay

A form of reconstruction where new concrete is placed into an area of removed pavement; the removal may be an individual lane, all lanes between the shoulders, or only partly through a slab.

Isolation Joint

A pavement joint that allows relative movement in three directions and avoids formation of cracks elsewhere in the concrete and through which all or part of the bonded reinforcement is interrupted. Large closure movement to prevent development of lateral compression between adjacent concrete slabs; usually used to isolate a bridge.

J**Joint**

A plane of weakness to control contraction cracking in concrete pavements. A joint can be initiated in plastic concrete or green concrete and shaped with later processes.

Joint Depth

The measurement of a saw cut from the top of the slab to the bottom of the cut.

Joint Deterioration

See *Spalling, Compression*.

Joint Filler

Compressible material used to fill a joint to prevent the infiltration of debris and to provide support for sealant.

Joint Sealant

Compressible material used to minimize water and solid debris infiltration into the sealant reservoir and joint.

Joint Shape Factor

Ratio of the vertical-to-horizontal dimension of the joint sealant reservoir.

Joint, Construction

See *Construction Joint*.

Joint, Contraction

See *Contraction Joint*.

Joint, Expansion

See *Expansion Joint*.

Jointed Plain Concrete Pavement (JPCP)

Pavement containing enough joints to control all natural cracks expected in the concrete.

Jointed Reinforced Concrete Pavement (JRCP)

Pavement containing some joints and embedded steel mesh reinforcement (sometimes called distributed steel) to control expected cracks; steel mesh is discontinued at transverse joint locations.

K

Keyway

A recess or groove in one lift or placement of concrete, that is filled with concrete of the next lift, giving shear strength to the joint. See also *Tongue and Groove*.

L

Laitance

A layer of weak material containing cement and fines from aggregates, brought to the top of overwet concrete, the amount of which is generally increased by overworking and overmanipulating concrete at the surface by improper finishing.

Layer

See *Course*.

Lean Concrete

Concrete of low cement content.

Life Cycle

In economic-impact management, the length of time over which an investment is analyzed; in environmental-impact management, consecutive and interlinked stages of a product system from raw material acquisition or generation from natural resources to final disposal.

Life-Cycle Assessment (LCA)

A technique that can be used to analyze and quantify the environmental impacts of a product, system, or process. Life-cycle assessment, in particular as applied to pavements, is an evolving field of study.

Life-Cycle Cost Analysis (LCCA)

Life-cycle cost analysis (LCCA) is a common economic analysis that accounts for the time value of money and is used for evaluating the total cost of an investment option over its entire life.

Lift

The concrete placed between two consecutive horizontal construction joints, usually consisting of several layers or courses.

Liquid Sealant

Sealant materials that install in liquid form and cool or cure to their final properties, relying on long-term adhesion to the joint-reservoir faces.

Load-Transfer Device

See *Dowel*.

Load-Transfer Efficiency

The ability of a joint or crack to transfer a portion of a load applied on the side of the joint or crack to the other side of the joint or crack.

Load-Transfer Restoration (LTR)

See *Retrofit Dowel Bars*.

Load-Transfer Assembly

Most commonly, the basket or carriage designed to support or link dowel bars during concreting operations so as to hold them in place in the desired alignment.

Longitudinal Broom

Surface texture achieved in a similar manner as transverse broom, except that the broom is pulled in a line parallel to the pavement centerline.

Longitudinal Joint

A joint parallel to the long dimension of a structure or pavement.

Longitudinal Reinforcement

Reinforcement essentially parallel to the long axis of a concrete member or pavement.

Longitudinal Tine

Surface texture achieved by a handheld or mechanical device equipped with a rake-like tining head that moves in a line parallel to the pavement centerline.

Lot

A defined quantity.

M

MEPDG

Guide for Mechanistic-Empirical Design of New and Rehabilitated Pavements (NCHRP 2004).

Map Cracking

- 1) Intersecting cracks that extend below the surface of hardened concrete are caused by shrinkage of the drying surface concrete, which is restrained by concrete at greater depths where either little or no shrinkage occurs and that vary in width from fine and barely visible to open and well-defined.
- 2) The chief symptom of a chemical reaction between alkalis in cement and mineral constituents in aggregate within hardened concrete due to a differential rate of volume change in different portions of the concrete; cracking is usually random and on a fairly large scale, and in severe instances the cracks may reach a width of ½ in. See also *Crazing* and *Pattern Cracking*.

Maximum Size of Aggregate

See *Aggregate, Maximum Size of (also called Maximum-Size Aggregate)*.

Membrane Curing

A process that involves either a liquid sealing compound (e.g., bituminous and paraffinic emulsions, coal-tar cutbacks, pigmented and nonpigmented resin suspensions, or suspensions of wax and drying oil) or nonliquid protective coating (e.g., sheet plastics or “waterproof” paper), both of which types function as films to restrict evaporation of mixing water from the fresh concrete surface.

Mesh

The number of openings (including fractions thereof) per unit of length in either a screen or sieve in which the openings are ¼ in. or less.

Mesh Reinforcement

See *Welded-Wire Fabric Reinforcement*.

Metakaolin

An ASTM C618 Class N natural pozzolan that is produced by heating the clay containing the mineral kaolin to a temperature between 1,000 and 1500°F.

Method-and-Material Specification

Specification that directs the contractor to use specified materials in definite proportions and specific types of equipment and methods to place the material.

Mix

The act or process of mixing; also a mixture of materials, such as mortar or concrete.

Mix Design

See *Proportioning*.

Mixer

A machine used for blending the constituents of concrete, grout, mortar, and cement paste, or another mixture.

Mixer, Transit

See *Truck Mixer*.

Mixing Cycle

The time taken for a complete cycle in a batch mixer; i.e., the time elapsing between successive repetitions of the same operation (e.g., successive discharges of the mixer).

Mixing Plant

See *Batch Plant*.

Mixing Speed

Rotation rate of a mixer drum or of the paddles in an open-top, pan, or trough mixer when mixing a batch, expressed in revolutions per minute (rpm) or in peripheral feet per minute of a point on the circumference at maximum diameter.

Mixing Time

The period during which the mixer is combining the ingredients for a batch of concrete. For stationary mixers, the time is measured from the completion of batching cement and aggregate until the beginning of discharge. For truck mixers, mixing is given in terms of the number of revolutions of the drum at mixing speed.

Mixing Water

The water in freshly mixed sand-cement grout, mortar, or concrete, exclusive of any previously absorbed by the aggregate (e.g., water considered in the computation of the net water/cement ratio). See also *Batched Water* and *Surface Moisture*.

Mixture

The assembled, blended, commingled ingredients of mortar, concrete, or the like, or the proportions for their assembly.

Modular Pavement Systems

Pavement composed of precast concrete components that can be used to rapidly construct or repair a section of roadway, thereby reducing user delays, or to provide an aesthetically pleasing design; they offer certain sustainability advantages.

Modulus of Rupture

A measure of the ultimate load-carrying capacity of a beam, sometimes referred to as “rupture modulus” or “rupture strength.” It is calculated for apparent tensile stress in the extreme fiber of a transverse test specimen under the load that produces rupture. See also *Flexural Strength*.

Moist

Slightly damp but not quite dry to the touch; the term “wet” implies visible free water, “damp” implies less wetness than “wet,” and “moist” implies not quite dry. See also *Damp* and *Wet*.

Moisture Content of Aggregate

The ratio, expressed as a percentage, of the weight of water in a given granular mass to the dry weight of the mass.

Moisture-Free

The condition of a material that has been dried in air until there is no further significant change in its mass. See also *Oven Dry*.

Mortar

Concrete with essentially no aggregate larger than about $\frac{3}{16}$ in.

Mud Balls

Balls of clay or silt (“mud”).

N

Natural Sand

Sand resulting from natural disintegration and abrasion of rock. See also *Sand* and *Fine Aggregate*.

NCHRP

National Cooperative Highway Research Program.

NHI

National Highway Institute.

Nonagitating Unit

A truck-mounted container for transporting central-mixed concrete that is not equipped to provide agitation (slow mixing) during delivery; a dump truck.

Non-Air-Entrained Concrete

Concrete in which neither an air-entraining admixture nor an air-entraining cement has been used.

No-Slump Concrete

Concrete with a slump of $\frac{1}{4}$ in. or less. See also *Zero-Slump Concrete*.

NRMCA

National Ready Mixed Concrete Association.

O

Open-Graded Aggregate

See *Aggregate, Open-Graded*.

Open-Graded Subbase

Unstabilized layer consisting of crushed aggregates with a reduced amount of fines to promote drainage.

Oven Dry

The condition resulting from having been dried to essentially constant weight in an oven at a temperature that has been fixed, usually between 221 and 239° F.

Overlay

The addition of a new material layer onto an existing pavement surface. See also *Resurfacing*.

Overlay, Bonded

See *Bonded Concrete Overlay*.

Overlay, Unbonded

See *Unbonded Concrete Overlay*.

Overlay, UTW

See *Ultra-Thin Whitetopping*.

Overlay, Whitetopping

See *Whitetopping*.

Oversanded

Containing more sand than would be required for adequate workability and satisfactory finishing characteristics.

Overvibrated

Concrete vibrated more than is necessary for good consolidation and elimination of entrapped air.

Overwet

The consistency of concrete when it contains more mixing water and hence is of greater slump than is necessary for ready consolidation.

P

Particle Size Distribution

The division of particles of a graded material among various sizes; for concrete materials, usually expressed in terms of cumulative percentages larger or smaller than each of a series of diameters or the percentages within certain ranges of diameter, as determined by sieving.

Paste

Constituent of concrete consisting of cement and water.

Pattern Cracking

Fine openings on concrete surfaces in the form of a pattern; resulting from a decrease in volume of the material near the surface, an increase in volume of the material below the surface, or both.

Pavement (Concrete)

A layer of concrete over such areas as roads, sidewalks, canals, airfields, and those used for storage or parking. See also *Rigid Pavement*.

Pavement Macrotexture

The deviations of a pavement surface from a true planar surface with the characteristic dimensions of wavelength and amplitude from 0.5 mm up to those that no longer affect tire-pavement interaction.

Pavement Structure

The combination of surface courses and base/subbase courses placed on a prepared subgrade to support the traffic load.

Paving Train

An assemblage of equipment designed to place and finish a concrete pavement.

Payback Time

The period between the initial environmental impact and the time to achieve a zero difference compared to a control condition.

PCA

Portland Cement Association.

PCC

Portland cement concrete.

Pea Gravel

Screened gravel, the particle sizes of which range between $\frac{3}{16}$ and $\frac{3}{8}$ in. in diameter.

Percent Fines

Amount, expressed as a percentage, of material in aggregate finer than a given sieve, usually the #200 sieve; also, the amount of fine aggregate in a concrete mixture expressed as a percent by absolute volume of the total amount of aggregate.

Performance-Based Specification

Specification that describes the desired levels of fundamental engineering properties (for example, resilient modulus and/or fatigue properties) that are predictors of performance and appear in primary prediction relationships (i.e., models that can be used to predict pavement stress, distress, or performance from combinations of predictors that represent traffic, environmental, roadbed, and structural conditions).

Performance-Related Specification

Specification that describes the desired levels of key materials and construction quality characteristics that have been found to correlate with fundamental engineering properties that predict performance. These characteristics (for example, strength of concrete cores) are amenable to acceptance testing at the time of construction.

Permeable Pavements

In those considered fully permeable, all pavement layers are intended to be permeable and the underlying pavement structure serves as a reservoir to store water during precipitation events to minimize the adverse effects of stormwater runoff.

Permeable Subbase

Layer consisting of crushed aggregates with a reduced amount of fines to promote drainage and stabilized with portland cement or bituminous cement.

Petrographic Analysis

The use of microscopes to examine samples of rock or concrete to determine their mineralogical and chemical characteristics typically performed due to the premature failure of an existing concrete structure or a problem during a construction project. The standard practice for conducting petrography of hardened concrete is ASTM C856.

Phasing

The sequences used by a contractor to build elements of a project.

Pitting

A localized disintegration taking the form of cavities at the surface of concrete.

Placement

The process of placing and consolidating concrete (also inappropriately referred to as "pouring"); a quantity of concrete placed and finished during a continuous operation.

Placing

The deposition, distribution, and consolidation of freshly mixed concrete in the place where it is to harden (also inappropriately referred to as "pouring").

Plain Bar

A reinforcing bar without surface deformations or one having deformations that do not conform to the applicable requirements.

Plain Concrete

Concrete without reinforcement.

Plain Pavement

Concrete pavement with relatively short joint spacing and without dowels or reinforcement.

Plane of Weakness

The plane along which a body under stress will tend to fracture; may exist by design, by accident, or because of the nature of the structure and its loading.

Plastic

Condition of freshly mixed cement paste, mortar, or concrete such that deformation will be sustained continuously in any direction without rupture; in common usage, concrete with slump of 3 to 4 in.

Plastic Consistency

A condition of freshly mixed concrete such that it is readily remoldable and workable, cohesive, has an ample content of cement and fines, but is not overwet.

Plastic Cracking

Cracking that occurs in the surface of fresh concrete soon after it is placed and while it is still plastic.

Plastic Deformation

Deformation that does not disappear when the force causing the deformation is removed.

Plastic Shrinkage Cracking

Cracks, usually parallel and only a few inches deep and several feet long, in the surface of concrete pavement that are the result of rapid moisture loss through evaporation.

Plasticity

The property of fresh concrete or mortar that determines its resistance to deformation or its ease of molding.

Plasticizer

A material that increases the plasticity of a fresh cement paste, mortar, or concrete.

Pneumatic

Moved or worked by air pressure.

Popout

Pit or crater in the surface of concrete resulting from cracking of the mortar due to expansive forces associated with a particle of unsound aggregate or a contaminating material, such as wood or glass.

Porosity

The ratio, usually expressed as a percentage, of the volume of voids in a material to the total volume of the material, including voids.

Portland Cement

A commercial product that when mixed with water alone or in combination with sand, stone, or similar materials has the property of slowly combining with water to form a hard solid mass. Physically, portland cement is a finely pulverized clinker, produced by burning mixtures containing lime, iron, alumina, and silica at high temperature and in definite proportions, and then intergrinding gypsum to give the properties desired.

Portland Cement Concrete

A composite material that consists essentially of a binding medium (portland cement and water) within which are embedded particles or fragments of aggregate, usually a combination of fine aggregate and coarse aggregate.

Portland-Pozzolan Cement

See *Cement, Portland-Pozzolan*.

Pozzolan

A siliceous or siliceous and aluminous material that in itself possesses little or no cementitious value but will in finely divided form and in the presence of moisture chemically react with calcium hydroxide at ordinary temperatures to form compounds possessing cementitious properties.

Pozzolan-Cement Grout

Common slab stabilization grout consisting of water, portland cement, and pozzolan; usually fly ash.

Preformed Compression Seal

Joint sealant that is manufactured ready for installation and is held in a joint by lateral pressure exerted against the reservoir by the seal after being compressed during installation.

Preservation

The process of maintaining a structure in its present condition and arresting further deterioration. See also *Rehabilitation, Repair, and Restoration*.

Pressure Relief

Cut made in a concrete pavement to relieve the compressive forces of thermal expansion during hot weather.

Process Control

Those quality assurance actions and considerations necessary to assess production and construction processes so as to control the level of quality being produced in the end product. This includes sampling and testing to monitor the process but usually does not include acceptance sampling and testing.

Profile Index

Smoothness qualifying factor determined from a profilograph trace and calculated by dividing the sum of the total counts above the blanking band for each segment by the sum of the segment length.

Profile Line

On a profile trace, line drawn by hand on the field trace to average out spikes and minor deviations caused by rocks, texturing, dirt, or transverse grooving.

Project Scoping

An early planning step in the development of a project where all project requirements are defined and a plan is developed to address them.

Proportioning

Selection of proportions of ingredients for mortar or concrete to make the most economical use of available materials to produce mortar or concrete of the required properties.

PSI

- 1) Pounds per square inch; a measure of the compressive, tensile or flexural strength of concrete as determined by an appropriate test.
- 2) In pavements, the Performance Serviceability Index.

Pumping

The forceful displacement of a mixture of soil and water that occurs under slab joints, cracks and pavement edges that are depressed and released quickly by high-speed heavy vehicle loads; occurs when concrete pavements are placed directly on fine-grained, plastic soils or erodible subbase materials.

Punchout

In continuously reinforced concrete pavement, the area enclosed by two closely spaced transverse cracks, a short longitudinal crack, and the edge of the pavement or longitudinal joint exhibiting spalling, shattering, or faulting.

Q

QA/QC

See *Quality Assurance* and *Quality Control*.

Quality Assurance

Planned and systematic actions by an owner or his representative to provide confidence that a product or facility meets applicable standards of good practice. This involves continued evaluation of design, plan and specification development, contract advertisement and award, construction, maintenance, and the interactions of these activities.

Quality Assurance/Quality Control Specification

Statistically based specification that is a combination of end result along with material and method specifications. The contractor is responsible for quality control (process control), and the highway agency is responsible for acceptance of the product.

Quality Control

Actions taken by a producer or contractor to provide control over what is being done and what is being provided so that the applicable standards of good practice for the work are followed.

R

Radiative Forcing

A measure, as defined by the Intergovernmental Panel on Climate Change (IPCC), of the influence a given climatic factor has on the amount of downward-directed radiant energy impinging upon the earth's surface.

Radius of Relative Stiffness

A character or property of a concrete slab that measures the stiffness of the slab in relation to that of the subgrade; it is expressed by the equation:

$$l = \sqrt[4]{\frac{E_c h^3}{12(1 - \mu^2)k}}$$

Random Crack

See *Uncontrolled Crack*.

Raveling

Displacement of aggregate or paste near the slab surface from sawing; normally indicates that concrete strength is too low for sawing.

Reactive Aggregate

Aggregate containing certain silica or carbonate compounds that are capable of reacting with alkalis in portland cement, in some cases producing damaging expansion of concrete.

Ready-Mixed Concrete

Concrete manufactured for delivery to a purchaser in a plastic and unhardened state.

Rebar

Abbreviation for "reinforcing bar." See *Reinforcement*.

Rebound Hammer

An apparatus that provides a rapid indication of the mechanical properties of concrete based on the distance of rebound of a spring-driven missile.

Reconstruction

The process of removing an existing pavement from its grade and replacing it with a completely new pavement.

Recycled Concrete

Concrete that has been processed for use, usually as aggregate.

Recycling

The act of processing existing pavement material into usable material for a layer within a new pavement structure.

Rehabilitation

The process of repairing or modifying a structure to a desired useful condition. See also *Preservation*, *Repair*, and *Restoration*.

Reinforced Concrete

Concrete containing adequate reinforcement (prestressed or not prestressed) and designed on the assumption that the two materials act together in resisting forces.

Reinforcement

Bars, wires, strands, and other slender members embedded in concrete in such a manner that the reinforcement and the concrete act together in resisting forces.

Reinforcement, Transverse

Reinforcement at right angles to the longitudinal reinforcement; may be main or secondary reinforcement.

Relative Humidity

The ratio of the quantity of water vapor actually present to the amount present in a saturated atmosphere at a given temperature; expressed as a percentage.

Release Agent

Material used to prevent bonding of concrete to a surface. See also *Bond Breaker*.

Remoldability

The readiness with which freshly mixed concrete responds to a remolding effort, such as jiggling or vibration, causing it to reshape its mass around reinforcement and to conform to the shape of the form. See also *Flow*.

Repair

To replace or correct deteriorated, damaged, or faulty materials, components, or elements of a structure. See also *Preservation*, *Rehabilitation*, and *Restoration*.

Reservoir

The part of a concrete joint that normally holds a sealant material. Usually a widening saw cut above the initial saw cut.

Restoration

The process of reestablishing the materials, form, and appearance of a structure to those of a particular era of the structure. See also *Preservation*, *Rehabilitation*, and *Repair*.

Resurfacing

The addition of a new material layer onto an existing pavement surface for the purposes of correcting a functional factor, such as smoothness or texture.

Retardation

Reduction in the rate of hardening or strength development of fresh concrete, mortar, or grout; i.e., an increase in the time required to reach initial and final set.

Retarder

An admixture that delays the setting of cement and hence of mixtures such as mortar or concrete containing cement.

Retempering

Addition of water and remixing of concrete or mortar that has lost enough workability to become unplaceable or unusable. See also *Temper*.

Retrofit Dowel Bars

Dowels that install into slots cut into the surface of an existing concrete pavement.

Revibration

A second vibration applied to fresh concrete, preferably as long after the first vibration as the concrete will still respond properly.

Rheology

The science of dealing with flow of materials, including studies of deformation of hardened concrete; the handling and placing of freshly mixed concrete; and the behavior of slurries, pastes, and the like.

Ribbon Loading

Method of batching concrete in which the solid ingredients, and sometimes the water, enter the mixer simultaneously.

Rich Mixture

A concrete mixture containing a large amount of cement.

Rigid Pavement

Pavement that will provide high bending resistance and distribute loads to the foundation over a comparatively large area.

Rock Pocket

A portion of hardened concrete consisting of a concentration of coarse aggregate that is deficient in mortar and is caused by separation during placement, insufficient consolidation, or both; see *Honeycomb*.

Rod

A specified length of metal, circular in cross section with one end rounded; used to compact concrete or mortar test specimens.

Rod, Tamping

A straight steel rod of circular cross section having one or both ends rounded to a hemispherical tip.

Rodability

The susceptibility of fresh concrete or mortar to compaction by means of a tamping rod.

Rodding

Compaction of concrete by means of a tamping rod. See also *Rod*, *Tamping*, and *Rodability*.

Roller-Compacted Concrete (RCC)

A stiff mixture of traditional concrete components that is often proportioned with higher aggregate content and lower cementitious material content than conventional concrete.

S**Sack (of Cement)**

See *Bag (of Cement)*.

Sample

A group of units or portion of material taken from a larger collection of units or quantity of material that serves to provide information that can be used as a basis for action on the larger quantity or on the production process; the term is also used in the sense of a sample of observations.

Sampling, Continuous

Sampling without interruption throughout an operation or for a predetermined time.

Sampling, Intermittent

Sampling successively for limited periods of time throughout an operation or for a predetermined period of time. The duration of sample periods and of the intervals between are not necessarily regular and are not specified.

Sand

The fine granular material (usually less than $\frac{3}{16}$ in. in diameter) resulting from the natural disintegration of rock or from the crushing of friable sandstone.

Sand Grout

Grout mixture containing water, portland cement, and sand.

Sand Streak

A streak of exposed fine aggregate in the surface of formed concrete caused by bleeding.

Saturated Surface Dry

Condition of an aggregate particle or other porous solid when the permeable voids are filled with water, but there is no water on the exposed surface.

Saturated Surface-Dry (SSD) Particle Density

The mass of the saturated surface-dry aggregate divided by its displaced volume in water or in concrete (also called Bulk Specific Gravity).

Saturation

- 1) In general, the condition of the coexistence in stable equilibrium of either a vapor and liquid or a vapor and solid phase of the same substance at the same temperature.
- 2) As applied to aggregate or concrete, the condition such that no more liquid can be held or placed within it.

Saw Blade, Abrasive

Concrete-sawing medium that uses nondiamond abrasion elements. These blades do not need water to cool, but water is sometimes used.

Saw Blade, Diamond

Concrete-sawing medium that uses industrial diamonds as the primary abrasion element. Blades are cooled with water to protect the host metal from melting and prematurely dislodging the diamonds.

Saw Cut

A cut in hardened concrete utilizing diamond or silicone-carbide blades or discs.

Sawed Joint

A joint cut in hardened concrete, generally not to the full depth of the member, by means of special equipment.

Sawing

Cutting of joints in hardened concrete by means of special equipment utilizing diamond or silicon-carbide blades or discs; cut goes only partway through the slab.

Scaling

Flaking or peeling away of the near-surface portion of hydraulic-cement concrete or mortar.

Schmidt Hammer (trade name), Swiss Hammer, or Rebound Hammer

A device used to estimate the compressive strength of hardened concrete by measuring surface hardness.

Scoping

See *Project Scoping*.

Screed

- 1) To strike off concrete lying above the desired plane or shape.
- 2) A tool for striking off the concrete surface, sometimes referred to as a strikeoff.

Screed Guide

Firmly established grade strips or side forms for unformed concrete that will guide the strikeoff in producing the desired plane or shape.

Screeding

The operation of forming a surface by the use of screed guides and a strikeoff. See also *Strikeoff*.

Sealant

See *Joint Sealant* and *Membrane Curing*.

Sealant Reservoir

The saw kerf or formed slot in which a joint sealant is placed. Many times this refers to a cut made to widen the original saw cut made for a contraction joint.

Sealing

The process of filling the sawed joint with material to minimize intrusion into the joint of water and incompressible materials.

Sealing Compound

See *Joint Sealant* and *Membrane Curing*.

Secondary Sawing

The sawing that takes place to establish shape in the joint. Many times this shape is the reservoir of the joint.

Segregation

The tendency, as concrete is caused to flow laterally, for coarse aggregate and drier material to remain behind and for mortar and wetter material to flow ahead. This also occurs in a vertical direction when wet concrete is overvibrated, the mortar and wetter material rising to the top. In the vertical direction, segregation may also be called Stratification.

Semiautomatic Batcher

A batcher equipped with gates or valves that are separately opened manually to allow the material to be weighed but that are closed automatically when the designated weight of each material has been reached.

Separation

The tendency, as concrete is caused to pass from the unconfined ends of chutes or conveyor belts, for coarse aggregate to separate from the concrete and accumulate at one side; the tendency, as processed aggregate leaves the ends of conveyor belts, chutes, or similar devices with confining sides, for the larger aggregate to separate from the mass and accumulate at one side; the tendency for solids to separate from the water by gravitational settlement. See also *Bleeding* and *Segregation*.

Set

The condition reached by a cement paste, mortar, or concrete when it has lost plasticity to an arbitrary degree, usually measured in terms of resistance to penetration or deformation. Initial set refers to first stiffening. Final set refers to attainment of significant rigidity.

Set-Accelerating Admixture

See *Accelerator*.

Set-Retarding Admixture

See *Retarder*.

Setting of Cement

Development of rigidity of cement paste, mortar, or concrete as a result of hydration of the cement. The paste formed when cement is mixed with water remains plastic for a short time. During this stage, it is still possible to disturb the material and remix without injury, but as the reaction between the cement and water continues, the mass loses its plasticity. This early period in the hardening is called the "setting period," although there is not a well-defined break in the hardening process.

Setting Time

The time required for a specimen of concrete, mortar or cement paste, prepared and tested under standardized conditions, to attain a specified degree of rigidity.

Settlement

Sinking of solid particles in grout, mortar, or fresh concrete after placement and before initial set. See also *Bleeding*.

Settlement Shrinkage

A reduction in volume of concrete prior to the final set of cementitious mixtures caused by settling of the solids and decreases in volume due to the chemical combination of water with cement.

Shrinkage

Decrease in length or volume.

Shrinkage Crack

Crack from restraint of volume reduction due to shrinkage or temperature contraction, usually occurring within the first few days after placement.

Shrinkage Cracking

Cracking of a slab due to failure in tension caused by external or internal restraints as reduction in moisture content develops.

Shrink-Mixed Concrete

Ready-mixed concrete mixed partially in a stationary mixer and then mixed in a truck mixer.

Sieve

A metallic plate or sheet, a woven-wire cloth, or other similar device with regularly spaced apertures of uniform size mounted in a suitable frame or holder for use in separating granular material according to size.

Sieve Analysis

The classification of particles, particularly of aggregates, according to sizes as determined with a series of sieves of different openings.

Silicone

A resin, characterized by water-repellent properties, in which the main polymer chain consists of alternating silicon and oxygen atoms, with carbon-containing side groups; silicones may be used in joint sealing compounds, caulking or coating compounds, or admixtures for concrete.

Silicone Sealant

Liquid joint sealant consisting of silicone-based material.

Skid Resistance

A measure of the frictional characteristics of a surface.

Slipform Paving

A type of concrete paving process that involves extruding the concrete through a machine to provide a uniform dimension of concrete paving.

Slipform

A form that is pulled or raised as concrete is placed; may move in a generally horizontal direction to lay concrete evenly for highway paving or on slopes and inverts of canals, tunnels, and siphons; or vertically to form walls, bins, or silos.

Slump

A measure of consistency of freshly mixed concrete equal to the subsidence measured to the nearest $\frac{1}{4}$ in. of the molded specimen immediately after removal of the slump cone.

Slump Cone

A mold in the form of the lateral surface of the frustum of a cone with a base diameter of 8 in., top diameter 4 in., and height 12 in., used to fabricate a specimen of freshly mixed concrete for the slump test.

Slump Loss

The amount by which the slump of freshly mixed concrete changes during a period of time after an initial slump test was made on a sample or samples thereof.

Slump Test

The procedure for measuring slump.

Slurry

Mixture of water and concrete particles resulting from concrete sawing or grinding.

Solid Volume

See *Absolute Volume (of Concrete or Mortar Ingredients)*.

Sounding

Process of tapping concrete slab surface with metal object, listening for tone from the impact, to determine areas of delamination.

Soundness

In the case of a cement, freedom from large expansion after setting. In the case of aggregate, the ability to withstand aggressive conditions to which the concrete containing it might be exposed, particularly those due to weather.

Spalling, Compression

Cracking, breaking, chipping, or fraying of slab edges within 0.6 m of a transverse joint.

Spalling, Sliver

Chipping of concrete edge along a joint sealant, usually within 12 mm of the joint edge.

Spalling, Surface

Cracking, breaking, chipping, or fraying of slab surface, usually within a confined area of less than 0.5 square m.

Specific Gravity

The ratio of the weight in air of a given volume of material at a stated temperature to the weight in air of an equal volume of distilled water at the same temperature.

Specific Gravity Factor

The ratio of the weight of aggregates (including all moisture), as introduced into the mixer, to the effective volume displaced by the aggregates.

Split Batch Charging

Method of charging a mixer in which the solid ingredients do not all enter the mixer together; cement, and sometimes different sizes of aggregate, may be added separately.

Spud Vibrator

A vibrator used for consolidating concrete, having a vibrating casing or head that is used via insertion into freshly placed concrete.

Standard Deviation

The root mean square deviation of individual values from their average.

Static Load

The weight of a single stationary body or the combined weights of all stationary bodies in a structure (such as the load of a stationary vehicle on a roadway); during construction, the combined weight of forms, stringers, joists, reinforcing bars, and the actual concrete to be placed.

Stationary Hopper

A container used to receive and temporarily store freshly mixed concrete.

Storage Hopper

See *Stationary Hopper*.

Straightedging

Process of using a rigid, straight piece of either wood or metal to strike off or screed a concrete surface to proper grade or to check the planeness of a finished surface.

Stratification

The separation of overwet or overvibrated concrete into horizontal layers with increasingly lighter material toward the top; water, laitance, mortar, and coarse aggregate will tend to occupy successively lower positions.

Strength

A generic term for the ability of a material to resist strain or rupture induced by external forces. See also *Compressive Strength*, *Flexural Strength*, and *Tensile Strength*.

Stress

Intensity of internal force (i.e., force per unit area) exerted by either of two adjacent parts of a body on the other across an imagined plane of separation; when the forces are parallel to the plane, the stress is called shear stress; when the forces are normal to the plane, the stress is called normal stress; when the normal stress is directed toward the part on which it acts, it is called compressive stress; when it is directed away from the part on which it acts, it is called tensile stress.

Strikeoff

To remove concrete in excess of that required to fill the form evenly or bring the surface to grade; performed with a straightedged piece of wood or metal by means of a forward sawing movement or by a power-operated tool appropriate for this purpose; also the name applied to the tool. See also *Screed* and *Screeding*.

Structural Capacity

Expression of the ability of a pavement to carry traffic loads; in AASHTO design methodology, structural capacity is expressed as the number of equivalent single-axle loads.

Subbase

A layer in a pavement system between the subgrade and base course or between the subgrade and a portland cement concrete pavement.

Subgrade

The soil prepared and compacted to support a structure or a pavement system, also sometimes called grade.

Sulfate Attack

Chemical or physical reaction between certain constituents in cement and sulfates in the soil or groundwater; sufficient attack may disrupt concrete that is susceptible to it.

Sulfate Resistance

The ability of aggregate, cement paste, or mixtures thereof to withstand chemical attack by sulfate ions in solution.

Superplasticizer

See *Water-Reducing Admixture (High Range)*.

Supplementary Cementitious Material

Mineral admixtures consisting of powdered or pulverized materials that are added to concrete before or during mixing to improve or change some of the plastic or hardened properties of portland cement concrete. Materials are generally natural or byproducts of other manufacturing processes.

Surface Moisture

Water retained on surfaces of aggregates capable of mixing with portland cement in concrete; distinguished from absorbed moisture, which is contained inside the aggregate particles.

Surface Retarder

A retarder used by application to a form or to the surface of newly placed concrete to delay setting of the cement to facilitate construction joint cleanup or to facilitate production of exposed aggregate finish.

Surface Tension

The property, due to molecular forces, that exists in the surface film of all liquids and tends to prevent the liquid from spreading.

Surface Texture

Degree of roughness or irregularity of the exterior surfaces of aggregate particles or hardened concrete.

Surface Vibrator

A vibrator used for consolidating concrete by application to the top surface of a mass of freshly mixed concrete; four principal types exist: vibrating screeds, pan vibrators, plate or grid vibratory tampers, and vibratory roller screeds.

Surface Voids

Cavities visible on the surface of a solid.

Surface Water

See *Surface Moisture*.

Swelling

Increase in length or volume, usually due to the absorption of water. See also *Contraction* and *Expansion*.

T**Tamper**

- 1) An implement used to consolidate concrete or mortar in molds or forms.
- 2) A hand-operated device for compacting floor topping or other unformed concrete by impact from the dropped device in preparation for strikeoff and finishing; the contact surface often consists of a screen or a grid of bars to force coarse aggregates below the surface to prevent interference with floating or troweling.

Tamping

The operation of compacting freshly placed concrete by repeated blows or penetrations with a tamping device.

Temper

The addition of water and mixing of concrete or mortar as necessary to bring it initially to the desired consistency. See also *Retempering*.

Tensile Strength

Maximum stress that a material is capable of resisting under axial tensile loading based on the cross-sectional area of the specimen before loading.

Terminal Joint

Joint used in continuously reinforced concrete pavement (see *CRC Pavement*) to transition to another pavement type or to a bridge structure.

Texturing

The process of producing a special texture on either unhardened or hardened concrete.

Thermal Expansion

Expansion caused by increase in temperature.

Thermal Movement

Change in dimension of concrete or masonry resulting from change in temperature. See also *Contraction* and *Expansion*.

Thermal Shock

The subjection of newly hardened concrete to a rapid change in temperature, producing a deleterious effect.

Tiebar

Bar at right angles to and tied to reinforcement to keep it in place; deformed bar extending across a construction joint to prevent separation of adjoining slabs.

Time of Haul

In production of ready-mixed concrete, the period from first contact between mixing water and cement until completion of discharge of the freshly mixed concrete.

Time of Set

Time required after addition of water to cement for cement paste, mortars, or concretes to attain a certain arbitrary degree of hardness or strength.

Time of Setting

See *Initial Setting Time* and *Final Setting Time*.

TMMB

Truck Mixer Manufacturers' Bureau; most truck mixers carry TMMB rating plates.

Tongue and Groove

A joint in which a protruding rib on the edge of one side fits into a groove in the edge of the other side, abbreviated "T & G." See also *Keyway*.

Topping

- 1) A layer of high-quality concrete placed to form a floor surface on a concrete base.
- 2) A dry-shake application of a special material to produce particular surface characteristics.

Transit-Mixed Concrete

Concrete, the mixing of which is wholly or principally accomplished in a truck mixer. See *Truck-Mixed Concrete*.

Transverse Broom

Surface texture obtained using either a hand broom or mechanical broom that lightly drags stiff bristles across the surface.

Transverse Crack

Crack that develops at a right angle to the long direction of the member.

Transverse Joint

A joint normal to the longitudinal dimension of a structure.

Transverse Reinforcement

See *Reinforcement*, *Transverse*.

Transverse Tine

Surface texture achieved by a handheld or mechanical device equipped with a rake-like tining head that moves laterally across the width of the paving surface.

TRB

Transportation Research Board.

Trial Batch

A batch of concrete used for establishing or checking proportions.

Trowel

A flat, broad-bladed steel hand tool used in the final stages of finishing operations to impart a relatively smooth surface to concrete floors and other unformed concrete surfaces; also, a flat triangular-bladed tool used for applying mortar to masonry.

Truck-Mixed Concrete

Concrete, the mixing of which is accomplished in a truck mixer.

Truck Mixer

A concrete mixer suitable for mounting on a truck chassis and capable of mixing concrete in transit. See also *Horizontal-Axis Mixer* and *Inclined-Axis Mixer*.

Two-Lift Composite Pavement

The placement of two wet-on-wet layers or bonding wet to dry layers of concrete, instead of the homogenous single layer commonly placed in concrete paving.

U**Ultra-Thin Whitetopping**

Thin layer of new concrete (2-4 in.), usually high strength and fiber reinforced, placed over a prepared surface of distressed asphalt.

Unbonded Concrete Overlay

Overlay of new concrete placed onto distressed existing concrete pavement with a layer of asphalt or other medium between the new and old concrete surfaces to separate them.

Uncontrolled Crack

A crack that is located within a slab away from the sawed joints.

Undersanded

A concrete mixture that is deficient in sand content, a condition associated with poor workability or finishing characteristics.

Unit Water Content

The quantity of water per unit volume of freshly mixed concrete, often expressed as pounds or gallons per cubic yard. It is the quantity of water on which the water/cement ratio is based and does not include water absorbed by the aggregate.

Unit Weight

See *Bulk Density* and *Specific Gravity*.

Unreinforced Concrete

See *Plain Concrete*.

Unsound Aggregate

An aggregate or individual particles of an aggregate capable of causing or contributing to deterioration or disintegration of concrete under anticipated conditions of service.

Uplift Beam

Beam-like movement-detection device used to monitor slab lift during slab stabilization.

Urban Heat Island Effect (UHIE)

A metropolitan area that is significantly warmer than its surroundings. As population centers grow in size, they tend to have a corresponding increase in average temperature due to the replacement of natural cover with darker, impermeable surfaces. Not to be confused with global warming.

V

Vibrated Concrete

Concrete compacted by vibration during and after placing.

Vibration

Energetic agitation of concrete produced by a mechanical oscillating device at moderately high frequency to assist consolidation and compaction.

Vibration Limit

The time at which fresh concrete has hardened sufficiently to prevent its becoming mobile when subject to vibration.

Vibration, External

External vibration employs vibrating devices attached at strategic positions on the forms and is particularly applicable to manufacture of precast items and for vibration of tunnel-lining forms; in manufacture of concrete products, external vibration or impact may be applied to a casting table.

Vibration, Internal

Internal vibration employs one or more vibrating elements that can be inserted into the concrete at selected locations and is more generally applicable to in-place construction.

Vibration, Surface

Surface vibration employs a portable horizontal platform on which a vibrating element is mounted.

Vibrator

An oscillating machine used to agitate fresh concrete so as to eliminate gross voids, including entrapped air but no entrained air, and produce intimate contact with form surfaces and embedded materials.

Vibratory Plate Compactor

Motorized, one-man tool consisting of a vibrating square plate that transmits energy to compact granular materials.

Volume Batching

The measuring of the constituent materials for mortar or concrete by volume.

W

Wash (or Flush) Water

Water carried on a truck mixer in a special tank for flushing the interior of the mixer after discharge of the concrete.

Waste

Materials that normally would be sent to a landfill, for which the cost of transport and processing is the only source of economic value. If the material has value beyond this, it is no longer considered a waste, but instead a coproduct. In some regional markets, fly ash can be categorized as waste; whereas, in other markets, it is clearly a coproduct because it has economic value beyond the cost of transport and disposal.

Water/Cement Ratio

The ratio of the amount of water, exclusive only of that absorbed by the aggregates, to the amount of portland cement in a concrete or mortar mixture; preferably stated as a decimal by weight.

Water/Cementitious Materials Ratio

The ratio of the amount of water, exclusive only of that absorbed by the aggregates, to the amount of portland cement and other cementitious material (fly ash, pozzolan, etc.) in a concrete or mortar mixture; preferably stated as a decimal by weight.

Water Gain

See *Bleeding*.

Water-Reducing Admixture

A material that either increases slump of freshly mixed mortar or concrete without increasing water content or maintains a workability with a reduced amount of water, the effect being due to factors other than air entrainment; also known as water reducer.

Water-Reducing Admixture (High Range)

A water-reducing admixture capable of producing large water or great flowability without causing undue set retardation or entrainment of air in mortar or concrete.

Weathering

Changes in color, texture, strength, chemical composition or other properties of a natural or artificial material due to the action of the weather.

Weight Batching

Measuring the constituent materials for mortar or concrete by weight.

Welded-Wire Fabric Reinforcement

Welded-wire fabric in either sheets or rolls, used to reinforce concrete.

Well-Graded Aggregate

Aggregate having a particle size distribution that will produce maximum density; i.e., minimum void space.

Wet

Covered with visible free moisture; not dry. See also *Damp* and *Moist*.

Wet Process

In the manufacture of cement, the process in which the raw materials are ground, blended, mixed, and pumped while mixed with water; the wet process is chosen where raw materials are extremely wet and sticky, which would make drying before crushing and grinding difficult.

Whitetopping

Concrete overlay pavement placed on an existing asphalt pavement.

Whitetopping, Conventional

Overlay of new concrete greater than 4 in. thick placed onto existing asphalt pavement with no particular steps taken to ensure bonding or debonding.

Whitetopping, Ultra-Thin

See *Ultra-Thin Whitetopping*.

Workability

The property of freshly mixed concrete or mortar that determines the ease and homogeneity with which it can be mixed, placed, compacted, and finished.

Working Crack

A crack in a concrete pavement slab that undergoes significant deflection and thermal opening and closing movements and is typically oriented transverse to the pavement centerline and near a nonfunctioning transverse contraction joint.

Y**Yield**

The volume of fresh concrete produced from a known quantity of ingredients; the total weight of ingredients divided by the unit weight of the freshly mixed concrete.

Z**Zero-Slump Concrete**

Concrete of stiff or extremely dry consistency showing no measurable slump after removal of the slump cone. See also *Slump* and *No-Slump Concrete*.

National Concrete Pavement
Technology Center

