

Helical Pile Foundation Guide for Bridge Structures

OCTOBER 2023

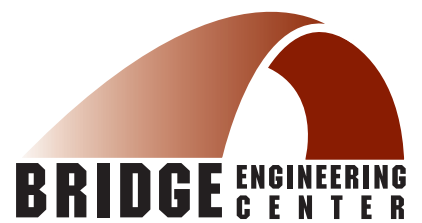

IOWA STATE UNIVERSITY
Institute for Transportation

About the Bridge Engineering Center

The mission of the Bridge Engineering Center (BEC) is to conduct research on bridge technologies to help bridge designers/owners design, build, and maintain long-lasting bridges.

About the Institute for Transportation

The mission of the Institute for Transportation (InTrans) at Iowa State University is to save lives and improve economic vitality through discovery, research innovation, outreach, and the implementation of bold ideas.

Iowa State University Nondiscrimination Statement

Iowa State University does not discriminate on the basis of race, color, age, ethnicity, religion, national origin, pregnancy, sexual orientation, gender identity, genetic information, sex, marital status, disability, or status as a US veteran. Inquiries regarding nondiscrimination policies may be directed to the Office of Equal Opportunity, 3410 Beardshear Hall, 515 Morrill Road, Ames, Iowa 50011, telephone: 515-294-7612, hotline: 515-294-1222, email: eooffice@iastate.edu.

Disclaimer Notice

The contents of this guide reflect the views of the authors, who are responsible for the facts and the accuracy of the information presented herein. The opinions, findings and conclusions expressed in this publication are those of the authors and not necessarily those of the sponsors.

The sponsors assume no liability for the contents or use of the information contained in this document. This guide does not constitute a standard, specification, or regulation.

The sponsors do not endorse products or manufacturers. Trademarks or manufacturers' names appear in this guide only because they are considered essential to the objective of the document.

Iowa DOT Statements

Federal and state laws prohibit employment and/or public accommodation discrimination on the basis of age, color, creed, disability, gender identity, national origin, pregnancy, race, religion, sex, sexual orientation or veteran's status. If you believe you have been discriminated against, please contact the Iowa Civil Rights Commission at 800-457-4416 or Iowa Department of Transportation's affirmative action officer.

If you need accommodations because of a disability to access the Iowa Department of Transportation's services, contact the agency's affirmative action officer at 800-262-0003.

The preparation of this report was financed in part through funds provided by the Iowa Department of Transportation through its "Second Revised Agreement for the Management of Research Conducted by Iowa State University for the Iowa Department of Transportation" and its amendments.

The opinions, findings, and conclusions expressed in this publication are those of the authors and not necessarily those of the Iowa Department of Transportation.

Acknowledgments

The research team would like to acknowledge the Iowa Highway Research Board (IHRB) and Iowa Department of Transportation (DOT) for sponsoring this research under IHRB Project TR-800, InTrans Project 21-783, Helical Pile Implementation for Bridge Structures. The Accelerated Bridge Construction University Transportation Center (ABC-UTC) at Florida International University (FIU) also provided some funding from the U.S. Department of Transportation Office of the Assistant Secretary for Research and Technology for this project.

The author would like to thank the technical advisory committee members for their guidance on this project.

For More Information

Bridge Engineering Center
Iowa State University Research Park
2711 S. Loop Drive, Suite 4700
Ames, IA 50010-8664
515-294-8103
<https://bec.iastate.edu>

Cover Image Credit

Bridge Engineering Center

Technical Report Documentation Page

1. Report No. IHRB Project TR-800	2. Government Accession No.	3. Recipient's Catalog No.	
4. Title and Subtitle Helical Pile Foundation Guide for Bridge Structures		5. Report Date October 2023	
		6. Performing Organization Code	
7. Author(s) Justin M. Dahlberg (orcid.org/0000-0002-6184-4122)		8. Performing Organization Report No. InTrans Project 21-783	
9. Performing Organization Name and Address Bridge Engineering Center Iowa State University 2711 South Loop Drive, Suite 4700 Ames, IA 50010-8664		10. Work Unit No.	
		11. Contract or Grant No.	
12. Sponsoring Organization Name and Address Iowa Highway Research Board Iowa Department of Transportation 800 Lincoln Way Ames, IA 50010 Accelerated Bridge Construction University Transportation Center Florida International University 10555 W. Flagler Street, EC 3680 Miami, FL 33174		13. Type of Report and Period Covered Guide	
		14. Sponsoring Agency Code IHRB Project TR-800	
15. Supplementary Notes Visit https://intrans.iastate.edu/ for color pdfs of this and other research publications.			
16. Abstract This project investigated helical pile foundation implementation for bridges, resulting in this design and construction guide. The simplicity and speed of helical pile installation, along with the ability to work within areas of limited size with smaller, more maneuverable equipment, can accelerate the construction of bridge structure foundations. This guide provides bridge engineers and designers with direction and specifications for this substructure foundation option, which can be advantageous on any bridge project, but particularly for low-volume roads where budgetary considerations tend to be a specific priority. This guide includes many useful design specification reference tables and also useful construction and installation documentation tools as examples and as table forms that can be used for helical pile bridge foundations.			
17. Key Words ABC foundations—accelerated bridge construction—bridge design—bridge substructures—deep foundations—helical pile contracting—helical pile foundations—helical pile installation—low-volume bridges—structural engineering		18. Distribution Statement No restrictions.	
19. Security Classification (of this report) Unclassified.	20. Security Classification (of this page) Unclassified.	21. No. of Pages 43	22. Price NA

Helical Pile Foundation Guide for Bridge Structures

October 2023

Principal Investigator

Justin M. Dahlberg, Director
Bridge Engineering Center, Iowa State University

Co-Principal Investigator

Brent M. Phares, Bridge Research Engineer
Bridge Engineering Center, Iowa State University

Author

Justin M. Dahlberg

Editor

Sue Stokke

Graphic Design and Layout

Alicia Hoermann

Sponsored by

Iowa Highway Research Board and Iowa Department of Transportation
(IHRB Project TR-800)

Preparation of this guide was financed in part through funds provided by
the Iowa Department of Transportation through its Research Management
Agreement with the Institute for Transportation (InTrans Project 21-783)

A guide from

Bridge Engineering Center
Institute for Transportation
Iowa State University

2711 South Loop Drive, Suite 4700

Ames, IA 50010-8664

Phone: 515-294-8103 / Fax: 515-294-0467

<https://bec.iastate.edu>

Contents

1. Introduction	1	4.7. Evaluate Structural Capacity.....	18
2. History and Other Applications	2	4.7.1. Shaft Design.....	18
2.1. History.....	2	4.7.2. Helix Plate Design.....	18
2.2. Other Applications.....	2	4.7.3. Couplers.....	18
2.3. Advantages and Limitations.....	2	4.7.4. Pile Caps.....	18
2.4. Definition of Terms.....	3	4.8. Evaluate Lateral Load Resistance.....	19
3. Materials, Equipment, and Installation	5	4.9. Evaluate Corrosion Protection.....	19
3.1. Introduction.....	5	4.10. Design Connections to Pile Caps.....	20
3.2. Sizes and Shapes.....	5	4.11. Estimate Contract Pile Length.....	20
3.3. Acceptance Criteria.....	5	4.12. Prepare Plan Drawings and Specifications.....	21
3.4. Helices.....	5	5. Construction Completion	22
3.5. Grouted Piles.....	6	5.1. Qualifications.....	22
3.6. Equipment.....	6	5.2. Submittals.....	22
3.7. Procedure.....	6	5.3. Installation Documentation.....	22
3.8. Construction Safety.....	6	5.4. Measurement and Payment.....	26
3.9. Torque Measurement.....	7	6. Example Specifications	27
3.10. Inspection.....	7	7. Construction Document Preparation	33
3.11. Termination into Pile Caps.....	7	References	37
4. Design Process	8		
4.1. Develop Bridge Situation Plan.....	8		
4.2. Develop Geotechnical Report.....	8		
4.3. Helical Pile Suitability.....	9		
4.4. Calculate Loading Combinations.....	12		
4.4.1. Limit States.....	12		
4.5. Assign Preliminary Pile Layout.....	12		
4.6. Evaluate Geotechnical Capacity.....	13		
4.6.1. Individual Bearing Method.....	14		
4.6.2. Cylindrical Shear Method.....	14		
4.6.3. Torque Correlations.....	15		
4.6.4. Lateral Load Resistance.....	15		
4.6.5. Size Selection.....	16		
4.6.6. Pile Deflection/Settlement.....	17		
4.6.7. Pullout Capacity.....	17		
4.6.8. Minimum Depth.....	17		
4.6.9. Down Drag.....	17		
4.6.10. Seismic Considerations.....	17		

Figures

Figure 1. Maplin Sands Lighthouse founded on screw piles.....	2
Figure 2. Helical pile lead sections.....	5
Figure 3. Helical pile extension sections.....	5
Figure 4. Helical pile installation equipment.....	6
Figure 5. Pile termination into footing – welded (left) and bolted (right).....	7
Figure 6. Example of Soil Boring Log.....	8
Figure 7. Flowchart for use of helical piles or another deep foundation system.....	10
Figure 8. Individual bearing method.....	14
Figure 9. Cylindrical shear method.....	15
Figure 10. Probability of poor performance with combined analysis and torque correlation.....	16
Figure 11. Pile head termination into concrete footing.....	19
Figure 12. Example of summary of foundations.....	33
Figure 13. Example of longitudinal section along the centerline of bridge.....	34
Figure 14. Example of pile notes.....	34
Figure 15. Example of plan view and section cut.....	35
Figure 16. Example of soil boring log.....	36

Tables

Table 1. Unified Soil Classification System and AASHTO Class.....	9
Table 2. Matrix for helical pile suitability.....	11
Table 3. Resistance factors for geotechnical resistance.....	13
Table 4. Resistance factor increase by load testing.....	13
Table 5. Helical pile installation logs.....	23
Table 6. Helical pile torque vs. depth below ground surface logs.....	24
Table 7. Helical pile grout information.....	25

1. Introduction

Helical pile foundation systems have been used for numerous applications and industries for many years. Their use has gained popularity more recently as concerted effort has been given to standardize design procedures, develop design tools, and develop the construction methods required to satisfy and ensure strength and serviceability requirements. As a result of these efforts, helical piles have been adopted into the International Building Code (International Code Council [ICC] 2009) as a deep foundation option.

Despite helical piles being recognized through code adoption, the advancement of helical pile technology and the development of the governing codes has been minimally focused on the bridge design community and the use of helical piles in bridge structures. Despite this fact, advances in the recent past will prove to benefit the bridge design community given the deep foundation methodology has largely been proven.

This document is intended to provide guidance to a bridge owner or engineer who may be seeking other deep foundation options. The remaining chapters in this document are as follows:

2. History and Other Applications
3. Materials, Equipment, and Installation
4. Design Process
5. Construction Completion
6. Example Specifications
7. Construction Document Preparation

Numerous resources were identified that provided valuable information for this project. Howard Perko's book, *Helical Piles: A Practical Guide to Design and Installation* (Perko 2009), was found to be a resource of significant value. The book is quite comprehensive and covers many aspects of helical pile technology in great detail, much beyond what can be summarized here. Anyone looking for additional information should seek out this resource.

Furthermore, the Deep Foundation Institute (DFI) has published a design guide (DFI 2019) that proves to be another valuable resource. Many of the guidelines provided in the document carryover to bridge foundation structures.

2. History and Other Applications

2.1. History

Alexander Mitchell, a European civil engineer, is credited with the first recorded use of helical piles in 1836. It was his solution to better found marine structures on weak soils. Prior to this time, Mitchell patented his invention in London in 1833, calling it a screw pile. Installation of the pile was completed using human and animal power using a large wooden handle wheel called a capstan. In 1838, the Maplin Sands Lighthouse was founded on nine screw piles 22 ft deep with a 4 ft diameter helix at the base and 5 in. diameter shafts (see Figure 1).

The use of screw piles continued on many marine structures (piers, lighthouses, etc.) throughout the mid to late 1800s, and their use gained traction in locations outside of Europe including the United States. More than 100 lighthouses were constructed on helical pile foundations along the East Coast and the Gulf Coast between the 1850s and 1890s.

At the turn of the century until the 1950s, the use of helical piles declined with the advancement of mechanical pile driving equipment and drilling equipment. Helical pile use became primarily for anchor applications until around 1980 when the first compression use of modern helical piles in the United States was recorded by an engineer, Stan Rupiper.

Advances in helical pile technology have accelerated in recent decades with many new patents being awarded. Accordingly, modern day applications for helical piles are vast in number. These include applications for residential homes, utility towers, commercial buildings, piers, decks, etc. Simply stated, the ability for helical piles to support

loads and be installed in areas that are otherwise difficult for other foundation technology installations has become attractive to engineers and owners of all types of projects. The continued use of helical piles is predictably high and the knowledge base is continually growing.

2.2. Other Applications

DFI 2019 lists numerous applications where helical pile technology is commonly used today. They are as follows:

- Residential structures
- Light and heavy commercial construction
- Industrial structures
- Machinery and equipment foundations
- Telecommunication and transmission towers
- Tie-downs for wind, buoyancy, and/or seismic forces
- Applications of limited or remote site access
- Foundation underpinning
- Tiebacks for slope stability

As is apparent by reviewing this list, the use of helical piles is vast and the type and magnitude of loads are wide ranging, which gives credence to their potential value for use on bridge structures.

2.3. Advantages and Limitations

As with any deep foundation option, advantages and disadvantages exist and should be considered when making a foundation selection. Some of the advantages and disadvantages are listed here.

Advantages

- Speed of installation
- Ability to work within areas of limited space
- Can be installed with smaller equipment
- Can be installed using various equipment types
- Can be installed in many soil strata types
- Very little ground preparation is required prior to installation
- Capacity is known immediately upon completion of installation
- Construction can continue immediately upon completion of installation
- No vibration or excessive noise during installation
- No spoils to remove

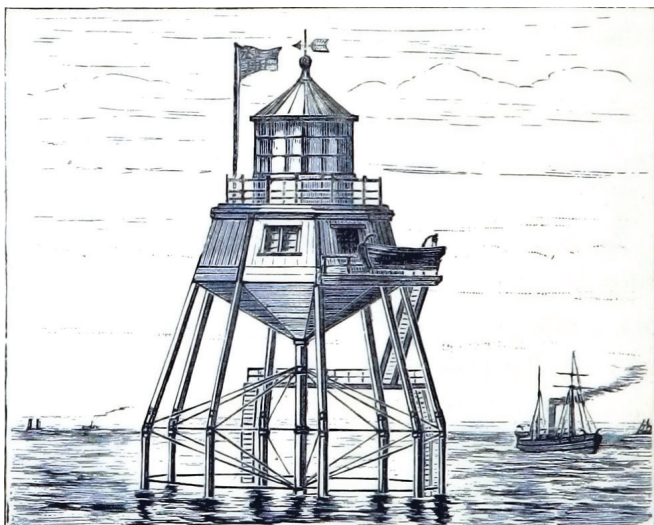

From the Mechanical Curator collection released to Flickr Commons by the British Library

Figure 1. Maplin Sands Lighthouse founded on screw piles

Disadvantages

- More difficult to bid given final pile length is often only estimated
- Rocky sites or sites with shallow bedrock are not ideal
- Installation standards are not fully developed for larger diameter helical pile shafts
- Have not been adopted into current bridge design codes

2.4. Definition of Terms

Allowable Load: See Nominal Load.

Bearing Stratum: Any soil layer that provides a significant portion of the axial load capacity of an installed helical pile by providing resistance to one or more of the pile's helical plates.

Crowd: Axial compressive force applied to the head (top) of the helical pile shaft during installation as required to ensure the pile progresses into the ground with each revolution a distance approximately equal to the helix pitch.

Deflection: Vertical movement of the helical pile foundation typically in the range of ½ to 1 in, or less for properly designed foundation systems.

Designer: One who oversees the decisions and design of a bridge structure and/or one who uses the site soils information and the principles of soil mechanics to design the helical pile foundation required for the calculated nominal loads.

Design Load: See Nominal Load.

Extension Section: A pile section without helical plates. Extension(s) are installed after the lead section. Each extension is connected with integral couplings that provide a rigid load transferring connection. The purpose of extension sections is to extend the lead section with helical plates to a load bearing stratum.

Factored Load: Nominal load times the required load factor (Load and Resistance Factor Design [LRFD]) or safety factor (Allowable Stress Design [ASD]).

Geotechnical Capacity (a.k.a. Ultimate Soil Capacity): The maximum load that can be resisted through bearing of helix plates in the soil which they are embedded.

Geotechnical Engineer: One who uses scientific methods and principles to interpret physical properties of soils to best advise the design of foundation structures.

Helical Pile: A steel pile consisting of one or more helical plates and is torqued into the soil until the lead section is embedded into a load bearing stratum where transfer of structural loads (tension and/or compression) occurs. The pile may include a surface coating or other means of corrosion protection.

Helix Plate: A round plate formed into a ramped spiral. When rotated into the soil, the helical shape provides thrust along its longitudinal axis aiding in pile installation. After installation, the plate transfers axial load into the soil through bearing.

Installation Torque: The resistance generated by a helical pile when installed into the soil. The installation resistance is a function of the strength properties of the soil that the helical piles are being installed in as well as the shaft geometry of the pile shaft and helical plates.

Lead Section: The first helical pile section installed into the soil consisting of one or more helix plates welded to the pile shaft.

Limit State: A condition beyond which a helical pile component or interface becomes unfit for service and is judged to no longer be useful for its intended function (serviceability limit state) or to be unsafe (strength limit state).

Loads: Forces or other actions that result from the weight of all building materials, occupants and their possessions, environmental effects, differential movement, and restrained dimensional changes. Permanent loads are those loads in which variations over time are rare or of small magnitude. All other loads are variable loads (see also Nominal Load).

Load Factor: A factor that accounts for deviations of the actual load from the nominal load (LRFD).

Load Test: A procedure to test the capacity and relation of load to movement by applying a compressive load on the helical pile.

Net Deflection: The total deflection at the pile head minus the theoretical elastic deformation of the pile during a load test.

Nominal Load: The magnitude of the loads determined by the owner's engineer, which includes dead, live, soil, wind, snow, rain, flood, and earthquake.

Reveal: The distance from the ground surface to the end of the last installed extension of a pile, measured along the pile's longitudinal axis.

Safety Factor: The ratio of ultimate resistance to the nominal load used for the design of any helical pile component or interface (ASD).

Service Load: Actual loads that are applied to a structure when the structure is in use.

Substructure: The part of the bridge that supports the superstructure and deck and distributes loads to the helical piles.

Torque Rating: The maximum torque energy that can be applied to a helical pile during installation into the soil.

Working Load: See Nominal Load.

Ultimate Bearing Resistance: Limit state based on the lesser of mechanical strength or geotechnical capacity of the helical pile defined as the point at which no additional load can be justified.

3. Materials, Equipment, and Installation

3.1. Introduction

Helical piles are a manufactured steel product that are made up of lead sections fabricated with a single helix or multiple helices coupled to extension sections and rotated into the ground until the required depth and design bearing strength are achieved. The pile sections can vary in size, shape, and cross-section, dependent on the load demand requirements of the supported structure. The components (Figure 2 and Figure 3) and installation methods are further discussed in the following sections.



BEC

Figure 2. Helical pile lead sections



BEC

Figure 3. Helical pile extension sections

3.2. Sizes and Shapes

Helical pile shafts come in various sizes and cross-sections. Most typically, the shafts are either square or round in cross-section and solid (square) or hollow (square and round). Typical sizes range from 1¼ in. to 2¼ in. per side for square sections and 2⅞ in. to 12 in. diameter for round sections. Shapes can be used in combination with each other to maximize the efficiency of the pile (e.g., square lead section coupled to round extension sections). The size and shape selected are dependent on the strength required and the soil strata in which the pile will be installed.

3.3. Acceptance Criteria

ICC-Evaluation Service (ICC-ES) Acceptance Criteria for Helical Pile Systems and Devices (AC358) provides the testing protocols to quantify performance characteristics of helical pile elements (ICC-ES 2007, 2016, 2020). AC358 was updated in 2016 to include 4.5 in. diameter round shafts and smaller hollow square shafts. Previously, it only covered small diameter helical piles that are 3.5 in. or smaller.

The development of acceptance criteria was seen as necessary to create standards and minimum requirements for the manufacturers of helical piles. The approval process now includes review of field and laboratory testing by an independent laboratory, calculation submittals, quality management documents, and other manufacturer information. A report is issued to manufacturers when AC358 requirements are satisfied and when the structural and installation torque-to-capacity relationships have been confirmed by independent agencies (DFI 2019).

3.4. Helices

Helices are steel plates welded to the pile shaft lead section. They are manufactured to be round in shape when viewed in line with the shaft. However, rather than being on a single plane, the helices are ramped with a constant defined pitch along the shaft as would be the thread on any manufactured screw. The unchanging pitch allows the pile to be installed without extensive ground disturbance and provides thrust along the longitudinal axis during installation, which benefits the overall installation process.

The configuration of helices can vary widely. A single pile can have multiple helices, and the helices can vary in diameter (e.g., 3 helices with diameters of 8 in., 10 in., and 12 in.). The size, spacing, and number of helices is dependent on the soil strata and required design capacity. The helices act to transfer axial load to the final bearing stratum once installation is complete. The spacing of helices is commonly 2.4 to 3.6 plate diameters apart. Contributions from individual plates are maximized when the spacing is in the range of 3 plate diameters.

3.5. Grouted Piles

Grout placement along the shaft is sometimes required to achieve the required axial and lateral capacity. Grouted piles have the benefit of added corrosion protection as well. To create a void in which the grout can be placed, a conical displacement plate is coupled to the shaft creating an annulus around the shaft. The grout, which primarily consists of a neat cement-water mix, is then gravity fed into a surface-level grout reservoir and into the void.

3.6. Equipment

The list of equipment necessary to install helical piles is relatively short. A hydraulic machine, such as a backhoe (see Figure 4), forklift, or skid-steer, among others, can be used with a torque motor capable of producing high torques at low speeds to install piles.

The torque motor should also be capable of clockwise and counterclockwise rotations and produce torques from 4,500 ft-lb for smaller piles up to 80,000 ft-lb for larger piles. The size of the hydraulic machine should be matched with the size of the torque motor, and the torque motor size should be matched with the piles being installed to ensure enough torque is provided without overstressing the piles.



BEC

Figure 4. Helical pile installation equipment

A torque indicator should be used either in line with the torque motor and helical pile or as part of the hydraulic system of the machine. Applied torque is correlated to the capacity of the pile and provides surety with respect to the ultimate capacity.

3.7. Procedure

Once the torque motor and torque indicator have been properly attached to the hydraulic machine, the helical pile lead section is coupled to the assembly with a drive pin. The lead section is positioned at its location of installation and the plumbness or inclination is checked from multiple vantage points.

A downward force, or crowd, is applied to the pile by the hydraulic machine forcing the tip into the ground. Once this is complete, the hydraulic machine can advance the pile into the ground until the point at which an extension is required.

An extension is coupled to the top of the installed section with connection bolts and to the hydraulic assembly with the drive pin. The process repeats until sufficient depth has been achieved to provide the capacity specified.

Previous installations have proven most successful when piles are installed continuously without starts and stops and at a rate of rotation less than 30 rpm. Faster rates can create an auguring effect if advancing from soft soils into hard soils.

3.8. Construction Safety

Marking utilities and being aware of overhead power lines must be done prior to installation commencing. Installing piles through underground utilities, especially electric or gas, or contacting overhead power lines could result in death.

Proper maintenance of hydraulic components reduce the risk of breakage. Bursting hydraulic lines can cause injury or death if someone is struck.

Installation can best be safely completed using a minimum of two workers with one worker operating the hydraulic machine while the other serves as a spotter, moves the pile sections, and completes the coupling and decoupling as necessary. The spotter also checks for plumbness and correct positioning. The hydraulic machine operator and spotter should have a clear sight line to one another to communicate quickly with hand signals.

Taking precautions against heavy equipment rollover is another essential in ensuring safe installation. An advantage to using helical piles is the ability to install them in locations that many other machines may not be able to access. However, this creates a risk for machine operators if proper attention is not paid to safety on the site.

Personal protective equipment, such as hard hats, boots, eye protection, and ear protection should also be worn at all times to reduce the risk of injury.

3.9. Torque Measurement

Measuring torque during installation is critical to evaluating the capacity of the helical pile. Methods for measuring torque are numerous, with many recent advances.

One method is the use of a shear pin indicator, where two adjoining circular plates are fixed together using varying numbers of calibrated shear pins. Once the torque reaches the capacity of the pins, the pins will shear and the plates will freely rotate about one another. This method is good for limiting the maximum shear but does not give a continuous shear readout during installation.

Mechanical dial gauge equipment with an internal strain transducer has been used with reasonable accuracy. A continuous torque reading is displayed, although the display continuously rotates with the torque motor making it difficult to read.

A load cell is similarly equipped with a strain gauge on its steel housing. A data acquisition device records the strain and converts the reading to torque, which is most often displayed to the operator in the hydraulic machine. Expense and fragility are the disadvantages to using load cells. However, newer battery-powered load cells remove the possibility of wire entanglement during installation.

Other devices measure inline pressure differential in the hydraulic hoses leading to and from the torque motor. This differential is converted to torque for the operator to observe.

3.10. Inspection

The frequency of inspection for helical pile installation can vary depending on the needs of the project and the willingness of the owner to invest in an inspection program. Some projects require inspection on all installed piles, while others may only require a small percentage to be inspected.

The subsurface conditions may also dictate the level of inspection required, given that highly variable conditions will likely result in variable torque readings at differing elevations. The variability may require modifications to the as-planned installation.

At a minimum, the torque and depth during installation and the final depth should be logged for each pile. Deviations from the plan should be recorded for as-built files.

3.11. Termination into Pile Caps

Pre-manufactured steel pile attachments are coupled to the end of the pile at an elevation required per the project plans. The attachments are coupled to the shaft either by welding or bolting (see Figure 5).

The attachments can take on several forms but are most often a simple, flat plate welded to the coupling section. The attachments are then embedded into the concrete pile cap, which allows the foundation compression or tension loads to be directly transferred to the pile. The attachments should be designed such that the design load to the concrete foundation and steel plates/welds does not develop stresses exceeding those allowed in the American Association of State Highway Transportation Officials (AASHTO) LRFD Bridge Design Specifications (BDS).

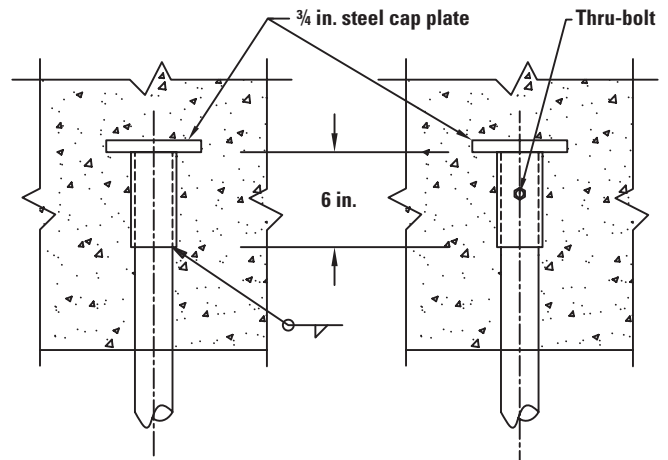

BEC

Figure 5. Pile termination into footing – welded (left) and bolted (right)

4. Design Process

The design process for helical piles similarly follows the process for other deep foundation types. The following steps are provided to guide an engineer through the necessary procedure for successfully completing the required design documents.

1. Develop bridge situation plan
2. Develop geotechnical report including soil borings
3. Review project requirements and assess helical pile suitability
4. Calculate all loading combinations
5. Determine foundation layout
6. Evaluate allowable geotechnical capacity and settlement
7. Evaluate allowable structural capacity against design loads
8. Evaluate lateral load resistance
9. Evaluate corrosion protection, if necessary
10. Design connection to pile caps
11. Estimate contract pile length
12. Prepare drawings and specifications

4.1. Develop Bridge Situation Plan

A bridge situation plan is important to convey the locations of existing and planned structures with respect to the overall site plan. Many items are to be included in a situation plan as is standard procedure for any bridge project. Specifically, as it pertains to the use of helical piles, it is essential that the following items are included.

- Dimensions of the proposed structure(s)
- Profile grade line labels
- Existing structure(s)
- Proposed grading slope lines
- Topography
- Minimum vertical clearance location (overhead bridges)
- Horizontal clearance to piers (overhead bridges)

4.2. Develop Geotechnical Report

Prior to the geotechnical report being developed per the requirements of the AASHTO LRFD BDS section 10.4 (AASHTO 2020), the engineer should have an estimated load demand and settlement limitations for the proposed structure to inform the geotechnical exploration team of the scope of investigation required. A geotechnical report, which includes soil boring logs and foundation recommendations, is essential to the final design of helical piles. A sample soil boring log is shown in Figure 6.

The soil boring logs should include a delineation of the depth, type, and classification of soil samples. Additionally, the boring logs should include standard penetration test (SPT) blow counts, soil cohesion, soil friction angle, weathered rock strength, ultimate bearing capacity and compressibility of each stratum, groundwater depth, and presence of cobbles, hard rock, or debris. The extent of soil exploration should be based on the extent of the project and the variability of the topography and subsurface conditions. Larger projects in areas of greater topographical and subsurface variability require more borings than those that are smaller or without variability.

BORING LOG NO. 1									
Project: Bridge					Client: Bridge Owner				
Site: Anytown, USA									
Graphic Log	Location	Depth (ft.)	Water Level Observations	Sample Type	Field Test Results	Sample ID	Water Content (%)	Dry Weight (pcf)	Atterberg Limits
	Approx. 3 inch root zone	0							
	FILL - SANDY LEAN CLAY, with gravel, gray with brown to gray, stiff to very stiff, occasional sand seams	3			3-2-2, N=4	1	17		
		5					2	21	75
	SANDY LEAN CLAY, trace gravel, gray with brown to gray, stiff to very stiff, occasional sand seams	3			3-2-2, N=4	3	13		
		10					4	12	114
		15				3-4-6, N=10	5	13	
		20				3-5-8, N=13	6	13	
		25				3-5-9, N=14	7	12	
		30				5-9-11, N=20	8	12	
		35				7-10-11, N=21	9	13	
		40				3-7-9, N=16	10	10	
					6-8-12, N=20	11	12		
Boring Terminated at 44.5 ft									
Advancement Method:					Notes:				
Water Level Observations					Bridge Geotech. Inc				

BEC

Figure 6. Example of Soil Boring Log

Table 1. Unified Soil Classification System and AASHTO Class

Soil Classification		Group Symbol	Typical Name	AASHTO Class
Coarse-grained soils	Gravels 50% or more of coarse fraction retained on No. 4 ASTM sieve	Clean gravels	GW Well-graded gravels and gravel-sand mixtures, little or no fines	A-1
			GP Poorly-graded gravels and gravel-sand mixtures, little or no fines	A-3
		Gravels with fines	GM Silty gravels, gravel-sand-silt mixtures	A-2
			GC Clayey gravels, gravel-sand-clay mixtures	A-2
	Sands More than 50% of coarse fraction passes No. 4 ASTM sieve	Clean sands	SW Well-graded sands and gravelly sands, little or no fines	A-1
			SP Poorly-graded sands and gravelly sands, little or no fines	A-3
		Sands with fines	SM Silty sands, and-silt mixtures	A-2
			SC Clayey sands, sand-clay mixtures	A-2
Fine-grained soils	Silts and Clays Liquid limit 50% or less	— ML Inorganic silts, very fine sands, rock flour, silty or clayey fine sands	A-4	
		— CL Inorganic clays or low to medium plasticity, gravelly clays, sandy clays, silty clays, lean clays	A-6	
		— OL Organic silts and organic silty clays of low plasticity	A-8	
	Silts and Clays Liquid limit greater than 50%	— MH Inorganic silts, micaceous or diatomaceous fine sands, or silts, elastic silts	A-5	
		— CH Inorganic clays of high plasticity, fat clays	A-7	
		— OH Organic clays of medium to high plasticity	A-8	
		Highly organic clays Pt Peat, muck and other highly organic soils	—	

Geotechnical engineers use the Unified Soil Classification System (USCS), as summarized in Table 1, to classify soils types.

The soil types are determined and then reported in the soils investigation reports. The AASHTO soil classification, which is used by most state departments of transportation (DOTs) is also provided in Table 1 for direct comparison.

The soil classification and description provide the information necessary to determine the suitability of helical pile use. Helical pile designers and installers have developed a good sense of predictability for expected pile behavior during and after installation based on the soil type(s) in which the pile is installed.

4.3. Helical Pile Suitability

Helical piles can be used in many locations and soil strata types. However, an engineer must be aware of some considerations when assessing suitability.

Figure 7 provides a flowchart that systematically steps through questions and instructions to aid the designer in selecting helical piles or another deep foundation system. Additionally, Table 2 provides a matrix of questions to help direct the engineer toward a decision on helical pile suitability. The questions are categorized by 1) Site and Constructability, 2) Geotechnical, and 3) Design Considerations. A response of Yes, No, Maybe, or N/A should be provided for each question.

Any questions answered as No or Maybe do not discount helical piles from being used. Rather, additional considerations should be evaluated before making a final decision. The commentary provided for each question provides additional information and instruction to assist the designer in their decision.

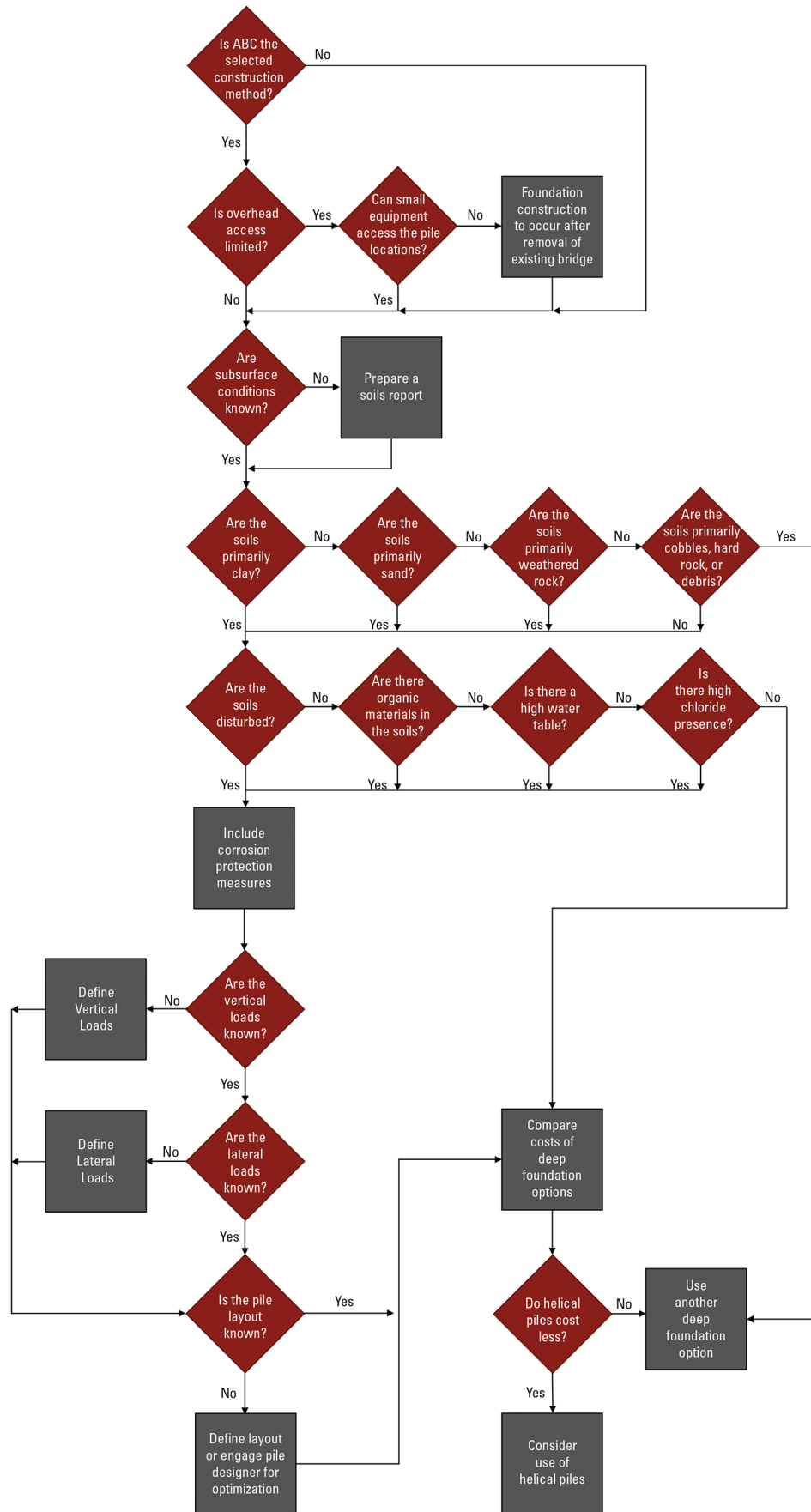

Figure 7. Flowchart for use of helical piles or another deep foundation system

Table 2. Matrix for helical pile suitability

Question	Yes	No	Maybe	N/A	Commentary
Site and Constructability					
Does the site topography allow access for multiple types of smaller equipment? (mini-excavator, rubber-tired backhoe, small-tracked machine)					Helical piles can be and are most often installed without the use of larger equipment—an advantage to using helical piles if site access for larger equipment is difficult.
Does the schedule require accelerated construction of deep foundations?					Helical pile installation can be completed more quickly than more traditional deep foundation options.
Are there overhead obstructions?					Overhead obstructions may limit or prohibit the use of larger equipment. Helical piles can be installed in low-overhead-clearance conditions.
Can welding and torch cutting be safely conducted on site?					Welding and/or torch cutting may be necessary to complete helical pile installation and should be considered if these activities can be safely completed.
Can large equipment access the site? (excavator)					In some instances of high-capacity helical piles, a larger excavator may be required for installation.
Geotechnical					
Are the subsurface conditions known?					A soils report will provide the necessary information for helical pile design. Unknown subsurface conditions do not necessarily prohibit helical pile use. Rather, uncertainty will be introduced into preliminary design.
Is the soil cohesive (clay)?					Helical pile use is conducive to cohesive soils.
Is the soil non-cohesive (sands and gravels)?					Helical pile use is conducive to non-cohesive soils.
Is there a presence of cobbles, hard rock, or debris?					The presence of cobbles, hard rock, or debris does not necessarily prohibit the use of helical piles, but special attention should be paid to these soil conditions given a more suitable foundation option may exist. Typical penetration limits for helical piles are 70 psf ultimate bearing pressure.
If weathered rock is present, is the strength known?					Weathered rock can provide additional end bearing capacity to helical piles.
Is corrosion protection of the piles required?					It is typical for helical piles to be corrosion-protected prior to onsite delivery. This affords the piles more protection against corrosive environments.
Will the piles be installed into disturbed soils?					The oxygen content in disturbed soils is greater, which can lead to increased corrosion rates of unprotected steel.
Will the piles be installed into soils that contain cinders or high concentrations of organic materials?					Organic material can increase the rate of corrosion on bare and protected steel. Adding sacrificial thickness in severe conditions is common.
Is the pile being installed into soils where the water table fluctuates and has appreciable salt content?					Corrosion of steel is accelerated in partial submersion zones. Sacrificial thickness and hot-dipped zinc galvanization can be used to protect the piles.
Design Considerations					
Is there a governing code for helical pile use/installation at the location of the bridge?					
Are the vertical loads for the foundation structure known or reasonably estimated?					Helical piles come in numerous sizes. The capacity is a function of size and soil conditions.
Are the lateral loads for the foundation structure known or reasonably estimated?					Battered helical piles can be used in cases where the lateral loads are significant.
Are overturning loads for the foundation structure known or reasonably estimated?					Helical piles offer significant tensile load capacity.
Is there a preferred pile layout?					Helical piles are generally adaptable to any preferred layout. However, the layout and pile size can be optimized if a specific layout is not required.
Is there a tolerable maximum displacement?					Helical piles offer similar maximum displacements as other deep foundation options.
Will multiple piles in single locations be allowed in the event of large loads?					Where large loads exist, helical pile sizes can be increased or multiple smaller piles can be used.
Will the pile layout be prescribed by the bridge designer?					A prescribed pile layout can be restrictive to a helical pile designer. Collaboration between the bridge designer and pile designer is recommended.
Can the pile spacing be optimized by the pile designer?					It is recommended that the helical pile designer be involved early on in order to optimize the pile size and layout.
Will battered piles be allowed to resist lateral loads?					Battered piles reach beyond the plan dimensions of the pile layout and should be coordinated with other underground objects.
Can the foundation reinforcement be readily kept free from touching the helical piles?					Steel reinforcement in contact with steel piles, including helical piles, has the potential to increase corrosive action. Ensuring non-contact where the pile terminates into the footing reduces the potential.
Totals:					

4.4. Calculate Loading Combinations

4.4.1. Limit States

For a helical pile foundation design for bridges, the designer is to consider applicable load combinations corresponding to the AASHTO LRFD BDS section 3.4.1 as follows:

- Strength I: Basic load combination relating to the normal vehicular use of bridge without wind loading
- Strength II: Load combination relating to the use of the bridge by owner-specified special design vehicles
- Strength III: Load combination relating to the bridge exposed to the design wind speed at the location of the bridge
- Strength IV: Load combination emphasizing dead load force effects in bridge superstructures
- Strength V: Load combination relating to normal vehicular use of the bridge with wind of 80 mph velocity
- Extreme Event I: Load combination including earthquake
- Extreme Event II: Load combination relating to ice load, collision by vessels and vehicles, and certain hydraulic events
- Service I: Load combination relating to the normal operational use of the bridge with a 70 mph wind and all loads taken at their nominal values

The factored axial load per pile shall be less than the factored resistance as follows:

$$\phi R_n \geq \gamma_i Q_i$$

Where:

ϕ = Resistance Factor

R_n = Nominal Strength

γ_i = Load Factor

Q_i = Load Effects

A helical pile foundation is to be designed for the resulting critical combinations including maximum axial force, maximum moment, and maximum shear.

The helical pile size and estimated length are to be determined by using LRFD as shown in the following sections and considering geotechnical resistance, structural resistance, and other design considerations applicable to helical pile foundations.

4.5. Assign Preliminary Pile Layout

A first step in preliminary foundation design is to determine the pile layout. As a general rule, use the minimum number of piles required for structural support. The minimum centerline spacing should be the larger of 2.5 ft or 2.5 times the pile size (AASHTO LRFD BDS section 10.7.1.2).

Helical piles are more efficiently used when spaced farther apart. The abutment or pier that is being supported by the piles should be designed to accommodate the final spacing. In the absence of helical pile-specific offset spacing in the AASHTO LRFD BDS, the author of this guide recommends that the current International Building Code (ICC 2021) be referenced. The code requires two lines of piles, offset at least one foot apart, for long straight walls to provide stability. In this case, piles are often staggered to avoid group-related effects attributable to close spacing. Large concentrated loads may require multiple piles closely spaced. Group effects need to be accounted for in this case.

When piles are closely spaced, the capacity of the group can become less than the sum of the individual piles when evaluated singly. AC308 (ICC-ES 2020) prescribes a minimum on-center spacing of 4 helical plate diameters to avoid group effect consideration. When this dimension is not met and group effects are considered, it does not necessarily mean the capacity of the group will be less than the sum of the individual piles. Group effects can also be avoided by slighting battering of the piles such that the spacing at the point of bearing is greater than the recommended minimum.

Once the preliminary pile layout has been determined, the loads calculated per the applicable load combinations are to be used to calculate the required nominal pile resistance required. This information is used in the next steps to evaluate the geotechnical and structural capacity of the piles.

4.6. Evaluate Geotechnical Capacity

The geotechnical capacity for helical piles is calculated in similar ways as it is for other deep foundation types. Fundamental soil mechanics principles apply and can be reviewed at length in numerous other resources. In the simplest form, the factored axial load per pile shall be less than the factored geotechnical resistance, or Nominal Strength \geq Required Strength, as is shown in following equation:

$$\phi R_n \geq \gamma_i Q_i$$

Where:

ϕ = resistance factor

R_n = nominal strength

γ_i = load factor

Q_i = nominal loads

The resistance is a combination of the bearing resistance of the helices and the skin friction resistance along the shaft. A more in depth discussion is included in the following sections.

Note that helical piles are not currently included in the AASHTO LRFD BDS (2020). The load and resistance factors used for helical pile design can be reasonably based on other pile types with similar construction methods. As an example, DFI 2019 suggests ungrouted helical piles can use the factors for driven piles, and grouted helical piles can use the factors for micropiles. A summary of resistance factors for deep foundations is provided in Table 3.

Applying the same logic of using resistance factors of other deep foundation types for helical piles, the resistance factors can be increased by load testing a certain number of piles. Table 4 provides a summary of AASHTO resistance factor increases.

Table 3. Resistance factors for geotechnical resistance

Method of Determination	Loading Condition for single element	Element	Soil Type	AASHTO Drilled Shaft	AASHTO Driven Pile	AASHTO Micropile
Estimated soil/rock property	Axial Compression	Side Resistance	Clay	0.45	0.25 to 0.40	0.55
			Sand	0.55	0.30 to 0.45	0.55
			Rock	0.55	—	0.55
		Tip Resistance	Clay	0.40	0.25 to 0.40	—
			Sand	0.50	0.30 to 0.45	—
			Rock	0.50	0.45	0.5
	Uplift	—	Clay	0.35	0.20 to 0.40	0.55
			Sand	0.45	0.20 to 0.40	0.55
			Rock	0.40	0.20 to 0.40	0.55
	Lateral	—	—	All	1.00	1.00

Source: AASHTO 2020

Table 4. Resistance factor increase by load testing

Method of Determination	Loading Condition for single element	Element	Soil Type	AASHTO Drilled Shaft	AASHTO Driven Pile	AASHTO Micropile
Static Load Test with dynamic testing on at least 2 piles/site and >2% of production piles	Axial Compression	—	All	0.70	0.80	0.80
Static load testing without dynamic testing		—	—	0.70	0.75	0.75
Wave equation analysis and hammer calibration		—	—	—	0.50	—
Pile driving equations		—	—	—	0.10 to 0.40	—
State load testing without dynamic testing	Uplift	—	—	0.60	0.60	0.60

Source: AASHTO 2020

Subsurface conditions are used to determine the shaft size and total number of helices on the shaft to achieve the required bearing capacity. Two methods are used to determine the helix spacing: individual bearing and cylindrical shear.

A relatively wide helical spacing dictates that the helices act independently, and the total bearing capacity is simply the sum of the bearing capacity from each helix. Alternatively, if the spacing is relatively small, the helices act as a group. The total bearing capacity then becomes the sum of the bottom helix and the side friction comprised of the projected cylinder between each of the helices.

The closeness of the helical bearing plates is relative based on the diameter of the helices and the surrounding soil conditions. The ideal spacing of helical bearing plates occurs where the calculated individual method and the cylindrical method capacities are equal. This creates efficiency by minimizing the shaft length and number of helices required.

For smaller shaft sizes (1.5 in. square to 3.5 in. in diameter), the optimal spacing is often taken as two to three times the average diameter of the helical bearing plates. The helical bearing plates should be spaced with respect to the pitch to ensure the helices follow the same path during installation.

4.6.1. Individual Bearing Method

The distribution of forces is assumed to be a uniform pressure distribution on the underside of each helical bearing plate. Additionally, adhesion stresses are assumed on the shaft along its length as shown in Figure 8.

The ultimate bearing capacity is the sum of the individual bearing capacities for each helical bearing plate plus the adhesion along the shaft, as given by the following equation:

$$P_u = \sum_n q_{ult} A_n + \alpha H (\pi d)$$

Where:

q_{ult} is the ultimate bearing pressure

A_n is the area of the nth helical bearing plate

α is the adhesion between the soil and the shaft

H is the length of the helical pile shaft above the top helix

d is the diameter of a circle circumscribed around the shaft

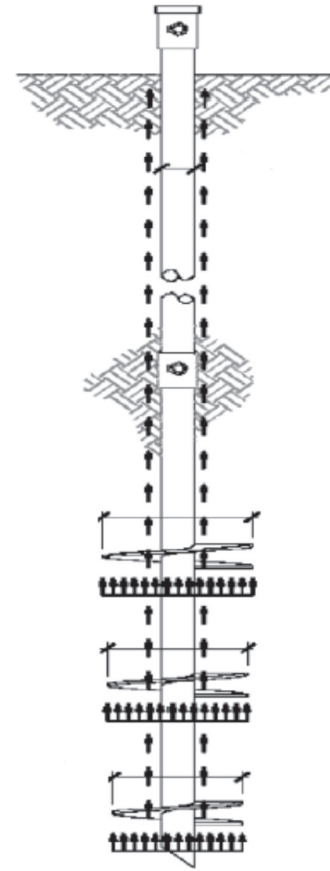

Perko 2009, © 2009 John Wiley and Sons, used with permission

Figure 8. Individual bearing method

4.6.2. Cylindrical Shear Method

For the cylindrical shear method, it is assumed that the entire volume of soil between the top and bottom helical bearing plates is mobilized. In this case, the lead helix is subjected to a uniform pressure on its bottom side, and the soil between the helices is subjected to shear interaction with the surrounding soils. Furthermore, adhesion stresses act along the length of the helical pile shaft located above the top helix as shown in Figure 9.

The ultimate bearing capacity is found by taking the sum of shear stress along the cylinder, adhesion along the shaft, and bearing capacity of the bottom helix, as given by the following equation:

$$P_u = q_{ult} A_1 + T(n-1)s\pi d_{AVG} + \alpha H(\pi d)$$

Where:

A_1 is the area of the bottom helix

T is the soil shear strength

H is the length of shaft above the top helix

d is the diameter of the pile shaft

$(n - 1)s$ is the length of soil between the helices

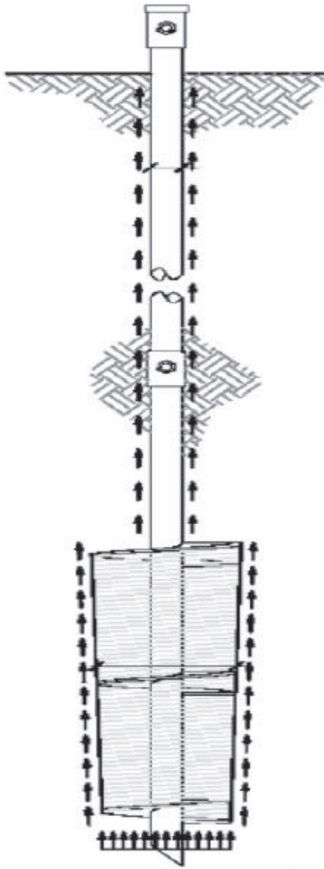

Perko 2009, © 2009 John Wiley and Sons, used with permission

Figure 9. Cylindrical shear method

All other parameters are the same as those for the individual bearing method.

The ultimate capacity should be determined by calculating capacities for both the individual bearing method and the cylindrical shear method and using the lower capacity value. The shaft adhesion portion of the previous equations is often ignored. Square shaft helical piles form an annulus around the shaft reducing soil to shaft contact, and the wobble of the shaft upon insertion can similarly create voids between the shaft and soil. Adhesion to the shaft has been found to be a greater contributor to the ultimate capacity in deep, larger-diameter shafts.

4.6.3. Torque Correlations

In situ strength of helical piles is correlated to installation torque. Similar to the results using the plate penetrometer test, the torque required to advance a pile into the ground is indicative of soil consistency and strength.

The ultimate axial capacity of helical piles was first provided in a calculation by Hoyt and Clemence (1989). The relationship is as follows:

$$P_u = K_t T$$

The parameter K_t is known as the capacity-to-torque ratio having units of ft^{-1} and was found to be a constant most closely related to the shaft diameter. Since the early studies and development of the K_t factor by Hoyt and Clemence, in which more than 90 pullout load tests at 24 different sites with varying soil types were completed, many other pile load tests have been completed with final installation torque recorded. The cumulative data show good correlation to the K_t parameter originally developed.

The differences in the tension and compression capacity correlation with installation torque is noteworthy. K_t values tend to be about 10% higher in compression than in tension, although it has become common practice to assume the same K_t value for compression and tension applications given the inherent variability due to soil conditions.

The ultimate capacity calculation based on the installation torque was shown to correlate well with the cylindrical shear method and individual bearing method, although these methods tend to more conservatively predict actual capacity. In other words, using the capacity-to-torque ratio often results in a greater predicted capacity than when using either of the other two methods.

Installers should also be aware of factors that may affect the ultimate capacity determined by the capacity-to-torque ratio. For example, helical piles can begin to auger the soil instead of advancing through the soil, especially when exiting a softer layer and entering a harder layer. The reduction in torque results in a lower and more conservative ultimate capacity. Augering can also occur when the helical bearing plates are not properly positioned and succeeding plates do not follow the same path as the leading plate.

The capacity-to-torque method does not apply when piles terminate on bedrock or other hard material or when piles are installed such that the top helix is less than 5 helix diameters below the surface (Pack 2000). Rather, load tests or limit state calculations are typically used to determine the ultimate capacity. The strength of the pile may govern which method to use.

4.6.4. Lateral Load Resistance

Helical piles with tubular shafts and rigid couplings are best suited to support lateral loads. Analysis is considered in two categories, rigid pile analysis and flexible pile analysis, depending on the installed configuration. Brom's Method is used for the former and L-Pile for the latter. The analysis for each takes the soil type into consideration.

The lateral soil pressure on a single pile in ground under lateral loads is on the order of two to three times greater than the Rankine passive earth pressure. The lateral stress distributions will overlap and be additive when the piles are spaced closer than three shaft diameters apart. Helical piles are often spaced to avoid group efficiency effects.

The lateral load capacity of helical piles can be increased by installing them at a batter angle. Where resistance of helical piles to vertical and horizontal loads is required, the batter angle can be optimized. Alternatively, two or more piles can be used to resist vertical and lateral forces individually. Tie-back anchors are helical piles installed at a shallow angle and are used to resist the horizontal loads in combination with vertically installed piles that are used to resist vertical loads.

Battered piles in seismic zones should be carefully considered. A significant increase in lateral stiffness of the foundation can create a situation where the superstructure experiences rapid movement in contrast to that of a more flexible structure that is less susceptible to high frequency translation.

4.6.5. Size Selection

The allowable capacity has been historically determined by applying a factor of safety to the ultimate capacity when using ASD. It was typical for a safety factor of 3.0 to be used for deep foundation designs. However, for helical piles, a safety factor of 2.0 is more typical when capacity is verified through torque correlations. This has been statistically justified based on the measured and predicted capacity of more than 100 load tests (Perko 2009). An even lower safety factor may be justified when a load testing program is employed. Now that LRFD is becoming a more common design methodology, resistance factors are used in lieu of factors of safety and were presented previously in Table 3 and Table 4.

To determine the size of helical piles, the soil conditions for which the piles will be installed and the anticipated loads should be accounted for. Using this information, the shaft size and shape, along with the size and number of helical bearing plates, can be determined. Several iterations may be required to optimize the design.

A multiple helix design may require a larger shaft due to the likely increased installation forces. Also, deep embedment will increase the friction forces on the shaft and will similarly increase installation forces.

When using multiple helix plates, effort should be made to position each of the helices in the same soil stratum for most efficient design. When placed in varying soil stratum, the helix in the stiffest layer of soil will tend to attract a disproportionate amount of load.

Numerous variables will be accounted for in the final design including helix size, pile spacing, depth to bearing stratum, and others. More than one solution exists depending on the choices made.

Commercially available software has been developed to help design engineers evaluate several possibilities and configurations (e.g., Ram Jack Helical Pile Design software and HeliCAP Helical Capacity Design software from CHANCE). Each of the software programs uses the individual bearing method for calculating the ultimate capacity and allows for numerous soil stratum to be defined.

Statistics show that using a combination of limit state analysis and torque correlations with a safety factor of 2.0 provides a reliability of 99.7% (capacity > demand). Whereas, using just limit state analysis or just torque correlation reduces the probability to near 90% or 97%, respectively. Each method is independent, so by combining the practices, the probability of high reliability greatly increases (see Figure 10).

A prudent practice is to use traditional limit state methods to size helical piles, and, then, verify the capacity using torque correlation (Chance/Atlas 2018).

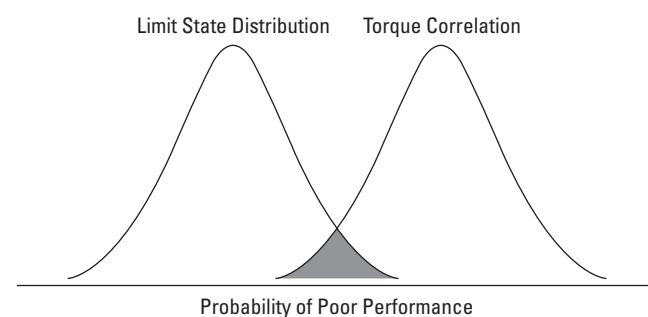

BEC

Figure 10. Probability of poor performance with combined analysis and torque correlation

4.6.6. Pile Deflection/Settlement

Helical piles designed with a minimum safety factor of 2.0 (ASD) have been found to have maximum settlements of about ½ in. to 1 in. or less under typical design loads (e.g., buildings). Engineers should expect to see similar results from helical piles designed using LRFD. This assumes good bearing material with a blow count of 20 or greater.

Highway bridge foundation loads can be greater than building foundations and, accordingly, may require longer helical piles, larger helical piles, helical piles with more helices, or a combination thereof. Soils with high blow counts and helical piles with larger diameter shafts can aid in limiting deflection.

The structural engineer should understand the settlement limits for the bridge structure given that elastic shortening effects may result in larger deflections (measured at the top of the helical pile) even with properly sized helical plates to match soil conditions.

In high to moderate seismic regions where granular, below-ground water table soil conditions exist and the blow count is less than 25, the soils can be prone to liquefaction resulting in the loss of lateral confinement of the piles. This should be recognized as a possible limiting factor for helical piles. However, helical piles have generally demonstrated good structure-supporting behavior during seismic events, which is further discussed in a following section.

4.6.7. Pullout Capacity

Pullout capacity is determined similarly to the bearing capacity when downward forces are applied, assuming the piles have been installed at a depth that ensures a deep mode of behavior. The individual bearing method and cylindrical shear method are both applicable, although the forces are reversed. The bearing stress moves to the top of the individual helices with the individual bearing method, and the bearing stress moves to the top helix with the cylindrical shear method.

A helical pile not installed deeply enough (too shallowly) will not have sufficient resistance to avoid pullout. Deep-mode behavior ensures that the minimum embedment of helical piles subject to tension forces is the depth at which the weight of a cone of soil above the shallowest helix is sufficient to provide the necessary pullout pressure. This is conservative, because it assumes a geometrical vertex at the shallowest helix. More rigorous and precise methods of determining the total weight of soil engaged during pullout exist and can be used.

4.6.8. Minimum Depth

The minimum recommended embedment depth for a helical pile deep foundation is five helix diameters ($5d$), where d is the diameter of the largest helix. The depth is measured from the ground surface to the top of the uppermost helix. Despite the minimum recommendation, the standard practice is to place the uppermost helix at least 6 to $8d$ below the ground surface. Further recommendations are to place the uppermost helix $3d$ below frost elevation to resist uplift during freezing conditions and below active zones to resist swelling soils.

4.6.9. Down Drag

Down drag occurs when soft or under-consolidated soils through which the pile is installed consolidate and create a downward force acting on the pile shaft. The transformation of the soils can be a result of pore water dissipation and placement of fill soils. The down drag forces are not unique to helical pile systems and can be calculated by a geotechnical engineer who is provided with the soils boring information. That said, given that helical pile shafts are generally small in comparison to other deep foundation types, and the helices are comparatively large, the magnitude of downward forces is less, and the resistance is greater.

4.6.10. Seismic Considerations

Evidence suggests that helical pile foundations have performed well during seismic events. After the 1994 Northridge earthquake in California, numerous helical pile-supported structures were assessed and were noted to perform better than other foundation types (Perko 2009). Similarly, buildings and other infrastructure were assessed after the Christchurch, New Zealand, earthquakes in 2011 and found to have performed quite well in comparison to other structures on different foundation types (Elsawy et al. 2019).

Piles with relatively small cross-sections and high uplift resistance are known to perform well during seismic events due to their slenderness, higher damping ratios, and ductility. More recent studies with a specific focus on the seismic behavior of helical piles have been completed (Cerato et al. 2017, Elsayy et al. 2017 and 2019) and engineers are encouraged to review these resources for a greater source of information.

4.7. Evaluate Structural Capacity

The structural capacity of the piles is often not the controlling factor when compared to the geotechnical capacity, yet it is essential to evaluate the structural capacity of the piles. The capacity of several elements of the helical pile should be determined including shaft, helix, coupler, and pile cap design.

4.7.1. Shaft Design

The shaft design capacity is going to be limited by either the axial capacity or the buckling load. A combination of loads (axial and bending) can control the design if the pile is subject to lateral loads or applied moments at the pile cap.

The axial capacity is simply a product of the area and the yield stress of the shaft multiplied by a resistance factor. The result should exceed the factored load to ensure sufficient axial capacity.

The lateral resistance provided to the pile shaft by surrounding soils, even soft soils, provides significant advantage to resisting pile buckling. However, if the pile becomes exposed either through scour or another reason, the slenderness of the pile can be susceptible to buckling failure. If susceptibility exists, a buckling analysis of the pile section should be completed.

Buckling analysis of helical piles are particularly important to complete in the following situations:

- Piles greater than 20 ft in length installed through a very soft clay into a very hard underlying layer and are end bearing
- Piles installed in loose, saturated clean sand that undergoes liquefaction during an earthquake event
- Piles subject to excessive eccentric loads without adequate bracing
- Piles subject to scour

Methods to improve the buckling capacity include using grouted shafts or larger diameter pipe shafts. Pipe shafts have a greater section modulus and larger lateral dimensions, which increases the resistance to lateral deflection in soil.

Specific instructions and calculations for buckling analysis can be found in Chance/Atlas (2018) and DFI (2019).

During installation, the helical pile is subjected to torsional forces. The piles should be checked to be sure

that the estimated torsional installation forces can be resisted by the pile section. Torsional analysis equations for solid square shaft, hollow round shaft, and hollow square shaft sections can be found in DFI (2019). Engineers also recommend evaluating the torsional capacity of the helix, the helix to shaft connection, and couplers.

The elastic deformation of pile sections may prove problematic in longer piles if unaccounted for. The designer should calculate the elastic deformation using the calculated loads and pile section properties. For additional precision, further evaluation of the deformation of coupler connections should be evaluated for bridge structures that are particularly sensitive to vertical movement.

4.7.2. Helix Plate Design

The torsional and vertical forces acting on the pile during installation and final load bearing condition will act on both the plates and the welds at the central shaft. The helical plates are typically designed by the pile manufacturer and are evaluated for the forces expected during installation and in their final state. The plate thickness and weld size to resist these forces are evaluated using normal steel design and welding design procedures.

4.7.3. Couplers

Pile section couplers should be evaluated for sufficient capacity. The axial loads (compression or tension) and torsional loads applied to the pile will also act on the couplers. The bending strength of the coupler and the shear strength of the bolts should be evaluated against the calculated bending and shear forces at the specific location of the pile. In some cases, the pile sections are joined by a weld. The welds should be similarly evaluated. Equations found in American Institute of Steel Construction (AISC) ANSI/AISC 360 can be used to evaluate the section size, bolt size, and weld size.

Additional evaluation of the coupler should be completed if it is anticipated that the coupler will exist in very soft soils or be exposed to air or water. The lack of lateral soil resistance can result in eccentricities acting on the pile resulting in forces that would otherwise not be seen.

4.7.4. Pile Caps

The pile head will terminate into a concrete footing in most cases. The minimum embedment into the footing should be at least 12 in. as shown in Figure 11.

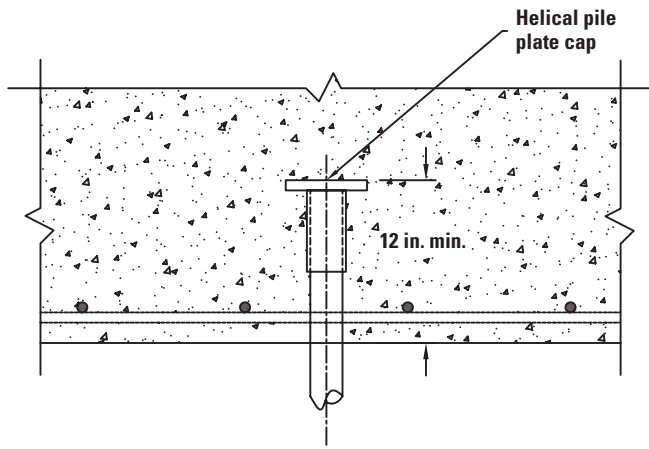

BEC

Figure 11. Pile head termination into concrete footing

The remaining pile cap design should follow standard concrete design codes and procedures that are common for other pile types, accounting for punching shear and breakout at the pile head, in addition to shear and flexure.

4.8. Evaluate Lateral Load Resistance

The structural design of any bridge will determine the magnitude and direction of lateral loads. These loads are to be resisted by the foundation system. In this case, helical piles may or may not be sufficient when installed in their vertical position. An analysis, not unlike that for other pile systems, should be performed.

The lateral capacity of piles can be calculated using a couple of different methods depending on the configuration and depth of the piles. For piles with a length less than 10 times the shaft diameter, the pile is considered rigid, and Broms or Brinch-Hansen methods can be used for analysis and design. Alternatively, for longer piles, a flexible pile analysis using the software program LPILE can be used (Ensoft Inc 2022). In either case, the methods are the same or similar to those used for other pile types.

In certain circumstances, the designer may identify a need to increase the lateral capacity. To bolster the lateral capacity of helical pile foundations, a couple of methods have proven to be useful.

The first method is to include an augered concrete cap. This method is completed by first augering a hole that is greater in diameter than the helical pile into the ground to a designed depth. The helical pile is then inserted into the hole and installed to a depth beyond that of the augered hole. The pile cap is formed, and, then, the hole and cap are filled with concrete.

The second method is to batter some of the piles. Battering the piles introduces a lateral component to the resisting force of the pile. For foundation systems that need only nominal additional lateral resistance, battering piles is a simple solution.

For situations where significant additional lateral resistance is required, a “jack leg” can be used. This is nothing more than a significantly battered pile. Although very effective in resisting lateral loads, a designer should be aware that the vertical force component of the jack leg will induce additional vertical forces into the vertical piles, which may not be insignificant and should be accounted for in the design of the vertical piles.

4.9. Evaluate Corrosion Protection

The soils in which helical piles can be installed vary widely. Accordingly, the potential of hydrogen (pH) levels in the soil may be at levels that would adversely affect a bare steel pile section, thereby compromising the structural integrity of a helical pile over its lifetime. A few methods have been used to mitigate the potential premature degradation of the piles, including the following:

- **Sacrificial thickness.** The thickness of the pile section is increased beyond what is required by the design calculations. The extra amount of steel can corrode leaving sufficient material to resist the design loads.
- **Hot-dip galvanizing.** The zinc coating applied to the pile through the hot-dip galvanizing process provides a protective layer to the underlying steel. The rate at which the zinc layer corrodes is dependent on the soil properties in which it will exist; however, the corrosion rate is much less than that for the bare steel, therefore affording the pile a much longer service life.
- **Epoxy coating.** Additional protective coatings like epoxy have been used less frequently and are most often used in special circumstances where one of the previous methods would not be considered adequate. Improvements in coating technology have increased abrasion resistance and the thickness range.
- **Cathodic protection.** This process uses a DC current connected to the below-grade piles. This method is not used as much and is often used in conjunction with another method. The design of the cathodic protection requires someone with particular expertise.

Batch hot-dip galvanizing has been most commonly used in the production of helical piles. Coatings are typically 3.5 to 4 mils thick. They result in a zinc iron alloy that is harder than steel, yet they remain reasonably flexible.

Galvanic corrosion can occur if the proper care to avoid contact and/or electric coupling of dissimilar metals is not taken. Zinc-coated steel and bare steel should not be used in the same helical pile system. Otherwise, helical piling may become a sacrificial anode to a bare steel structure. Electric isolation between the helical piles and bare steel and concrete reinforcing steel is critical to avoid galvanic corrosion. Engineers recommend using the same material with the same protective coating and using one corrosion rate for the entire pile system.

Zinc coatings have shown to reduce underground corrosion rates by as much as 50% to 98%. Several methods of coating with zinc exist, although mechanical plating, electroplating, and batch hot-dip galvanizing are the three recognized methods in the acceptance of helical piles.

Pits and scratches in zinc coatings can occur upon installation. Galvanic corrosion protects exposed steel in areas up to 1/8 in. wide.

Perko (2004) showed the effects of galvanization through the analysis of corrosion data. Twenty pairs of galvanized and bare pipe were buried in varying soil types around the United States and later assessed for the reduction in the corrosion rate of the galvanized sample. For each of the samples and soil types, the reduction in the corrosion rate ranged from a minimum of 50% to 98%. Even in the worst case, the rate of corrosion was reduced by half.

Corrosion of zinc-coated steel in water and air vary based on the environment. Marine environments are generally more corrosive and, therefore, require maintenance sooner than zinc-coated steel unexposed to those environments. It is unlikely, however, that many helical piles would remain exposed given their intended purpose and design.

4.10. Design Connections to Pile Caps

The design of helical pile connections to the pile caps is not unlike the design for other pile types. The size and depth of the concrete cap is a function of the loads imposed on the pile cap from the substructure elements and the pile arrangement. Using typical concrete design principles and methods, the reinforcement size and quantity should exceed the minimum required

reinforcement and provide the strength necessary so that the factored shear and flexural resistance of the pile cap exceeds the factored loads. The designer should be sure to check the pile cap for beam shear and punching shear.

Per AASHTO LRFD BDS section 10.7.1.2 (AASHTO 2020), the minimum embedment of the pile into the cap for driven piles shall be at least 12.0 in. into the pile cap as shown previously in Figure 11. Similarly, AASHTO states that the distance from the side of any pile to the nearest edge of the pile cap shall not be less than 9.0 in. Given that AASHTO does not directly address the design of helical pile foundations, bridge engineers recommend that the minimum embedment and edge distance for driven piles be adopted.

The pile termination into the concrete reinforced pile cap is most often completed using a bearing cap plate. A plate is welded to a sleeve approximately 6 in. in length that slides over the end of the pile. The sleeve is coupled to the top of the pile by welding or using bolts as shown previously in Figure 5.

4.11. Estimate Contract Pile Length

The contract pile length will be determined using the soils report information and LRFD nominal geotechnical resistance values and resistance factors. Using available helical-pile-specific design software, which incorporates the number and size of the helical plates, the size and shape of the shaft, and the soil layer properties, the pile lengths can be closely estimated. The final length of the pile will be determined upon installation when the torque correlation indicates that sufficient capacity is met.

Depending on the variability of the soil types and layer depth, piles may need to be extended to meet the design capacity on site. Similarly, piles may meet the design capacity at a depth less than what was estimated. The contract documents should include a pile data table to clearly indicate the acceptance criteria of the designed piles with respect to the depth, maximum torque, and bearing capacity. The inherent variability in pile length may be considered in the type of contract employed for pile acquisition and installation. This is discussed more in the next chapter.

4.12. Prepare Plan Drawings and Specifications

Plan drawings and specifications are essential in communicating the specific requirements of design and construction. The completion of these documents can be conducted in a couple of different ways.

A common practice is for the design and installation of helical piles to be completed by a single design-build contractor where contractually allowed. In this case, the engineer of record (EOR) typically establishes the specifications for the helical piles, the foundation dimensions, and the foundation loads. This information, along with the site soils investigation report, is used by

the design-build contractor to complete the helical pile design and layout, which is conveyed back to the EOR for inclusion in the final plan set.

The EOR may complete a helical pile design using available guides and software with the more traditional design-bid-build project delivery. The final design is included in the plan set along with the specifications and necessary information for a contractor to bid the pile installation.

With bridges, the project delivery method is often dictated by the governing state or jurisdiction. In any case, design and construction options are available for helical piles.

5. Construction Completion

5.1. Qualifications

Helical piles do not have a history of commonplace use like other foundation types. Subsequently, fewer installers with many years of experience are available. This does not need to hinder the use of helical piles, but it does change how an installer's qualifications may be viewed.

Helical pile manufacturers offer certification training to installation contractors. This training educates the installer on the technical aspects and installation procedures that are required by the manufacturer. At a minimum, the site superintendent should be certified, but engineers recommend that all workers be sufficiently trained and skilled in the specific requirements and methods needed to complete the installation properly. Furthermore, workers on site should have familiarity with the installation equipment and be able to contact a knowledgeable representative of the equipment and pile manufacturers if unforeseen issues arise.

The soils report and boring logs provide valuable information to the helical pile engineer and installer and should be referenced throughout the installation process. In some circumstances, the installer may find inconsistencies between what is expected during installation and what is actually experienced, often through the real-time torque measurements. Profiling the soil in all locations can be cost-prohibitive, and soil strata types and depths may be missed during the initial investigation as a result. Therefore, the installer should have the ability to speak directly to the helical pile engineer during installation to discuss potential changes to installation depth or helical pile configuration.

Designers recommend that helical piles be installed in the presence of an inspector who represents the foundation engineer. Similar to installers, inspectors should be trained and educated on the technical factors of helical piles and how unforeseen subsurface conditions can require onsite design or installation modification. Inspectors should document the final configuration and placement of the piles and especially those that differ from the plan documents.

5.2. Submittals

Contractor submittals communicate many important aspects to the owner and engineer that are important in verifying a quality product and installation. Prior to helical pile installation, agencies recommend that the qualifications of the contractor, the material certifications for the piles, the connection details for the footings, a list of primary installation equipment, and the work plan be submitted to the owner's representative for review and approval. Additional submittals specific to the helical pile plan include the following:

- Helical pile number, location, and pattern by assigned identification number
- Helical pile design load
- Type and size of central steel shaft
- Helix configuration including the total number and distance between helical plates
- Helix plate diameter, thickness, and pitch
- Helix pile tip geometry and length
- Coupling details
- Minimum effective installation torque
- Minimum overall length and cut-off elevation
- Inclination angle
- Minimum cased length, if applicable

5.3. Installation Documentation

After installation, the installation records for each pile and the as-built drawings should be submitted by the contractor as final documentation. To accurately document the installation of each pile, the information in Table 5 through Table 7 should be recorded.

Table 5. Helical pile installation logs

Project Information	
Design Installation Criteria	
Minimum pile tip depth or penetration into a specified stratum	
Minimum installation torque	
Horizontal location tolerance	
Verticality tolerance	
Equipment Information	
Drill Rig	
Drill head and maximum rated torque	
Method of measuring torque	
Pile Information	
Pile number	
Ground elevation during installation	
Design cutoff elevation	
Minimum required stickup length	
Predrill depth	
Predrill method and hole diameter	
Length of lead section	
Extension 1 - Length	
Extension 2 - Length	
Extension 3 - Length	
Extension 4 - Length	
Extension 5 - Length	
Extension 6 - Length	
Extension 7 - Length	
Final pile tip depth	
Final pile tip elevation	
Final pile head stick-up above ground	
Plumbness in N/S direction	
Plumbness in E/W direction	
Reason for installation termination	

Source: Adapted from DFI 2019

Table 6. Helical pile torque vs. depth below ground surface logs

Torque vs. Depth Below Ground Surface

Depth (ft)	Torque	Depth (ft)	Torque	Depth (ft)	Torque	Depth (ft)	Torque
0		20		40		60	
1		21		41		61	
2		22		42		62	
3		23		43		63	
4		24		44		64	
5		25		45		65	
6		26		46		66	
7		27		47		67	
8		28		48		68	
9		29		49		69	
10		30		50		70	
11		31		51		71	
12		32		52		72	
13		33		53		73	
14		34		54		74	
15		35		55		75	
16		36		56		76	
17		37		57		77	
18		38		58		78	
19		39		59		79	

Average torque over the last 3 helix plate diameters of helical pile penetration	
Torque at pile termination	

Source: Adapted from DFI 2019

Table 7. Helical pile grout information

Grout Information, if applicable

Grout mix	
Grout design strength	
Minimum grout strength	
Grout supplier	
Target grouting pressure over depth range	
Method of measuring grout volume	

Depth	Target grout volume	Grout volume pumped	Grout pressure
0			
5			
10			
15			
20			
25			
30			
35			
40			
45			
50			
55			
60			
65			
70			
75			
80			

Source: Adapted from DFI 2019

5.4. Measurement and Payment

Measurement and payment methods can vary depending on how the owner and contractor structure the contract(s). Four options are explained below.

Lump Sum: The benefit to the owner is that the costs are fixed, although the contractor will likely be conservative to reduce the financial risk, since the disadvantage to the contractor is the potential for longer piles to reach the required strength. The method lends itself well to design-build contracts. Loads and locations are provided to the pile contractor and the pile design and attachment to the structure are under the contractor's responsibility.

Price per Pile: The same advantages and disadvantages of lump sum exist, although the added benefit of the price for adding or subtracting piles is made by prior agreement.

Price per Foot: This method is preferred by contractors due to the variability of subsurface conditions. The owner can benefit by shorter overall pile lengths or, conversely, be required to pay for additional installed pile lengths. Specifications and scope should be narrow to accurately compare bids, although allowances for field modifications should be made.

Time and Materials: Payment is made on a unit rate basis for hourly rates, materials, and equipment rental. This method is useful on projects with limited subsurface information and in design-build approaches. The owner, engineer, pile designer, and contractor can work together to optimize time and materials. However, estimating total project cost is more difficult for the owner. The contract can be written with a guaranteed maximum cost and incentives for early completion.

6. Example Specifications

A sample specification for a bridge construction project using a helical pile deep foundation is provided in this chapter. Note that this is only an example and all specifications should be carefully reviewed and modified as necessary by the engineer to ensure compatibility with the specific project for which the specification applies.

Helical Pile Deep Foundation

Description.

This work consists of furnishing all design, materials, tools, equipment, labor and supervision, and installation techniques necessary to install helical piles as detailed on the plan sheets, including connection details.

A. Definitions.

Allowable Load: See “Nominal Load” below.

Bearing Stratum: Any soil layer which provides a significant portion of the axial load capacity of an installed helical pile by providing resistance to one or more of the pile’s helical plates.

Crowd: Axial compressive force applied to the head (top) of the helical pile shaft during installation as required to ensure the pile progresses into the ground with each revolution a distance approximately equal to the helix pitch.

Design Load: See “Nominal Load” below.

Extension Section: A pile section without helical plates. Extension(s) are installed after the lead section. Each extension is connected with integral couplings which provide a rigid load transferring connection. Their purpose is to extend the lead section with helical plates to a load bearing stratum.

Factored Load: Nominal load times the required load factor (Load and Resistance Factor Design) or safety factor (Allowable Stress Design).

Geotechnical Capacity (a.k.a. Ultimate Soil Capacity): The maximum load that can be resisted through bearing of helix plates in the soil which they are embedded.

Helical Pile: A steel pile consisting of one or more helical plates which is torqued into the soil until the lead section is embedded into a load bearing stratum where transfer of structural loads (tension and/or compression) occurs. The pile may include a surface coating or other means of corrosion protection.

Helix Plate: A round plate formed into a ramped spiral. When rotated into the soil, the helical shape provides thrust along its longitudinal axis thus aiding in pile installation. After installation, the plate transfers axial load into the soil through bearing.

Installation Torque: The resistance generated by a helical pile when installed into the soil. The installation resistance is a function of the strength properties of the soil the helical piles are being installed in as well as the shaft geometry of the pile shaft and helical plates.

Lead Section: The first helical pile section installed into the soil consisting of one or more helix plates welded to the pile shaft.

Limit State: A condition beyond which a helical pile component or interface becomes unfit for service and is judged to no longer be useful for its intended function (serviceability limit state) or to be unsafe (strength limit state).

Loads: Forces or other actions that result from the weight of all building materials, occupants and their possessions, environmental effects, differential movement, and restrained dimensional changes. Permanent loads are those loads in which variations over time are rare or of small magnitude. All other loads are variable loads (see also Nominal Load below).

Load Factor: A factor that accounts for deviations of the actual load from the nominal load (Load and Resistance Factor Design).

Load Test: A procedure to test the capacity and relation of load to movement by applying a compressive load on the helical pile.

Net Deflection: The total deflection at the pile head minus the theoretical elastic deformation of the pile during a load test.

Nominal Load: The magnitude of the loads determined by the owner’s engineer, which includes dead, live, soil, wind, snow, rain, flood and earthquake.

Reveal: The distance from ground surface to the end of the last installed extension of a pile, measured along the pile's longitudinal axis.

Safety Factor: The ratio of ultimate compression resistance to the nominal load used for the design of any helical pile component or interface (Allowable Stress Design).

Torque Rating: The maximum torque energy that can be applied to a helical pile during installation into the soil.

Working Load: See "Nominal Load" above.

Ultimate Bearing Resistance: Limit state based on the lesser of mechanical strength or geotechnical capacity of the helical pile defined as the point at which no additional load can be justified.

B. Quality Assurance.

- a. The Contractor shall be experienced in performing design and construction of helical piles and shall furnish all materials, labor, and supervision to perform the work. The Contractor shall be trained and certified by the helical pile system manufacturer in the proper methods of design and installation of helical piles. Provide names of on-site personnel materially involved with the work, including those who carry documented certification from the helical pile system manufacturer. At a minimum, these personnel shall include foreman, machine operator, and project engineer/manager.
- b. The Contractor shall provide evidence of the installing contractor's competence in the installation of helical piles to the owner's satisfaction and may include any or all of the following:
 - i. Pile manufacturer's certificate of competency in installation of helical piles
 - ii. A list of at least three projects completed within the previous three years wherein the installing contractor installed helical piles similar to those shown on the project plans. Such list is to include names and phone numbers of those project owner's representatives who can verify the installing contractor's participation in those projects, and/or
 - iii. A letter from the pile manufacturer, pile distributor or manufacturer's representative expressing ability and intent to provide on-site supervision of the pile installation.

- c. All helical piles shall be installed in the presence of a designated representative of the Engineer unless said representative informs the Contractor otherwise.
- d. Helical pile components as specified shall be manufactured by a facility whose quality systems comply with ISO (International Organization of Standardization) 9001 requirements. Certificates of Registration denoting ISO Standards Number shall be presented upon request to the Engineer or their representative.
- e. The helical piles shall be recognized by the International Code Council (ICC) and the manufacturer shall hold a current ICC-ES issued ESR report showing compliance with AC308.

C. Design

- a. The Contractor shall be responsible for the design of the helical piles. Design of helical piles shall be performed by a professional engineer licensed in the state of the project. Helical piles shall be designed to meet the specified loads and acceptance criteria as shown on the plans. These loads shall include vertical and longitudinal loads as indicated on the plans. In addition, the helical piles shall be designed to resist lateral loads as indicated on the plans. The calculations and shop drawings required from the Contractor or helical pile engineer shall be submitted to the Contracting Authority for review and acceptance.
- b. Provide documentation to demonstrate the helical piles are designed adequately to support the design loads as indicated on the plans with a suitable load factor for permanent structures. This documentation shall include, but is not limited to, engineering calculations for the helical piles, load factor used, analytical and test data for past performance of helical piles, and load charts correlating drive torque to bearing capacity. This documentation shall be approved by the Contracting Authority prior to installation of the helical piles.
- c. Helical Pile capacity in soil shall not be relied upon from any soil layers identified as incapable of contributing to the pile capacity as identified in the geotechnical reports.
- d. The helical pile attachment (pile cap) shall distribute the design load to the concrete foundation such that the concrete bearing stress and the stresses in the steel plates/welds do not exceed that allowed in the AASHTO LRFD BDS.

D. Ground Conditions.

- a. The geotechnical report, including logs of soil borings, shall be considered to be representative of the in situ subsurface conditions likely to be encountered on the project site. The geotechnical report shall be used as the basis for helical pile design using generally accepted engineering judgment and methods. The Contractor may conduct additional geotechnical investigations at no additional cost to the Contracting Authority.
- b. The geotechnical report shall be provided for purposes of bidding. If during helical pile installation, subsurface conditions of a type and location are encountered of a frequency that were not reported, inferred and/or expected at the time of preparation of the bid, the additional costs required to overcome such conditions shall be considered as extras to be paid for.

E. Submittals.

- a. Prepare and submit to the Engineer, for review and approval, working drawings and design calculations for the helical pile foundation intended for use at least 14 calendar days prior to planned start of construction. All submittals shall be signed and sealed by a Professional Engineer licensed in the state of the project.
- b. Submit a detailed description of the construction procedures proposed for use to the Engineer for review. This shall include a list of major equipment to be used. The working drawings shall include the following:
 - i. Bridge number, bridge name, and project number
 - ii. Helical pile number, location and pattern by assigned identification number
 - iii. Helical pile design load
 - iv. Type and size of central steel shaft
 - v. Helix configuration (number and diameter of helical plates)
 - vi. Minimum effective installation torque
 - vii. Minimum overall length
 - viii. Inclination angle (-0- for vertical piles)
 - ix. Minimum cased length, if applicable
 - x. Cut-off elevation

- c. Submit shop drawings for all helical pile components, including casing components and pile top attachment to the Engineer for review. This includes helical pile lead and extension section identification (manufacturer's catalog numbers).
- d. Submit certified mill test reports for the central steel shaft, as the material is delivered, to the Engineer for record purposes. The ultimate strength, yield strength, % elongation, and chemistry composition shall be provided.
- e. Submit to the Engineer copies of calibration reports for each torque indicator and all load test equipment to be used on the project. The calibration tests shall have been performed within one year of the date submitted. Helical pile installation and testing shall not proceed until the Engineer has received and approved the calibration reports. These calibration reports shall include, but are not limited to, the following information:
 - i. Name of project and Contractor
 - ii. Name of testing agency
 - iii. Identification (serial number) of device calibrated
 - iv. Description of calibrated testing equipment
 - v. Date of calibration
 - vi. Calibration data
- f. Work shall not begin until all the submittals have been received and reviewed and approved by the Engineer. Allow the Engineer 14 days to review, comment, and return the submittal package after a complete set has been received. All costs associated with incomplete or unacceptable submittals shall be the responsibility of the Contractor.

Materials.

Material for the helical piles shall be manufactured by a helical pile manufacturer meeting the requirements of this specification. Submit the selected manufacturer to the Engineer for approval.

Components of the helical pile system shall be in accordance with the following:

A. Central Steel Shaft.

The central steel shaft, consisting of lead sections, helical extensions, and plain extensions, shall comply with the following minimum requirements:

1. Round-Cornered-Square (RCS) solid steel bars: Shall be hot rolled RCS solid steel bars meeting dimensional and workmanship requirements of ASTM A29. The bar shall be either modified medium carbon steel grade with improved strength due to fine grain size or high strength low alloy (HSLA), low to medium carbon steel grade with improved strength due to fine grain size.
 - Minimum torsional strength rating= 5500 foot-pounds
 - Minimum yield strength = 70 ksi
 - RCS solid steel bars shall only be used in conjunction with a grout column of 4 to 10 inches to provide lateral stability to the central shaft. The grout shall be a neat grout with a compressive capacity of no less than 4000 psi per ASTM C1107. All appropriate displacement plates and spacings shall be shown in the shop drawings.
2. Structural steel tube or pipe: Shall be seamless or straight-seam welded, per ASTM A53, ASTM A500, or ASTM A618.
 - Minimum wall thickness is 0.3125 inches (schedule 80).
 - Torsional strength rating= 11,000 foot-pounds
 - Minimum yield strength= 50 ksi

B. Helical Bearing Plate.

Shall be hot rolled carbon steel sheet, strip, or plate formed on matching metal dies to true helical shape and uniform pitch. Bearing plate material shall conform to the following ASTM specifications: ASTM A709, A1018, or A656 with minimum yield strength of 50 ksi. Minimum plate thickness is $\frac{3}{8}$ inches.

C. Bolts.

The size and type of bolts used to connect the central steel shaft sections together shall conform to the following ASTM specifications:

- For use with solid square shafts: $\frac{3}{4}$ inch diameter bolts per ASTM A320 Grade L7.
- For use with solid square shafts: $\frac{7}{8}$ inch diameter bolts per ASTM A193 Grade B7.
- For use with solid square shafts: $1\frac{1}{8}$ inch diameter bolts per ASTM A193 Grade B7.
- For use with solid square shafts: $1\frac{1}{4}$ inch diameter bolts per ASTM A193 Grade B7.
- For use with steel tube or pipe shafts: $\frac{3}{4}$ inch diameter bolts per SAE J429 Grade S.

D. Couplings.

Shall be formed as integral part of the plain and helical extension material. The couplings shall be hot upset forged sockets or hot forge expanded sockets.

E. Plates, Shapes, or Pier Caps.

Structural steel plates and shapes for helical pile top attachments shall conform to ASTM A709 Grade 50.

Construction.

A. Installation Records.

Provide the Contracting Authority copies of helical pile installation records within 24 hours after each installation is completed. Records shall be prepared in accordance with these specifications. Formal copies shall be submitted on a weekly basis. These installation records shall include, but are not limited to, the following information.

- Name of project and Contractor
- Name of Contractor's supervisor during installation
- Date and time of installation
- Name and model of installation equipment
- Type of torque indicator used
- Location of helical pile by assigned identification number
- Actual helical pile type and configuration – including lead section (number and size of helix plates), number and type of extension sections (manufacturer's SKU numbers)

- Total length of installed helical pile
- Cut-off elevation
- Inclination of helical pile
- Installation torque at one-foot intervals for the final 10 feet
- Comments pertaining to interruptions, obstructions, or other relevant information
- Rated load capacities

B. Site Conditions.

1. Prior to commencing helical pile installation, inspect the work of all other trades and verify that all said work is completed to the point where Helical Piles may commence without restriction.
2. Verify that all helical piles may be installed in accordance with all pertinent codes and regulations regarding such items as underground obstructions, right-of-way limitations, utilities, etc.

C. Installation Equipment.

1. Shall be rotary type, hydraulic power driven torque motor with clockwise and counterclockwise rotation capabilities. The torque motor shall be capable of continuous adjustment to revolutions per minute (RPM's) during installation. Percussion drilling equipment shall not be permitted. The torque motor shall have torque capacity 15% greater than the torsional strength rating of the central steel shaft to be installed.
2. Equipment shall be capable of applying adequate down pressure (crowd) and torque simultaneously to suit project soil conditions and load requirements. The equipment shall be capable of continuous position adjustment to maintain proper helical pile alignment.

D. Installation Tooling.

1. Installation tooling should be maintained in good working order and safe to operate at all times. Flange bolts and nuts should be regularly inspected for proper tightening torque. Bolts, connecting pins, and retainers should be periodically inspected for wear and/or damage and replaced with identical items provided by the manufacturer. Heed all warning labels. Worn or damaged tooling should be replaced.
2. A torque indicator shall be used during helical pile installation. The torque indicator can be an integral part of the installation equipment or externally mounted in-line with the installation tooling.

- a. Shall be capable of providing continuous measurement of applied torque throughout the installation.
- b. Shall be capable of torque measurements in increments of at least 500 foot-pounds.
- c. Shall be calibrated prior to pre-production testing or start of work. Torque indicators which are an integral part of the installation equipment, shall be calibrated on-site. Torque indicators which are mounted in-line with the installation tooling, shall be calibrated either on-site or at an appropriately equipped test facility. Indicators that measure torque as a function of hydraulic pressure shall be calibrated at normal operating temperatures.
- d. Shall be re-calibrated, if in the opinion of the Engineer and/or Contractor reasonable doubt exists as to the accuracy of the torque measurements.

E. Central Steel Shaft Installation Procedures.

1. The helical pile installation technique shall be such that it is consistent with the geotechnical, logistical, environmental, and load carrying conditions of the project.
2. The lead section shall be positioned at the location as shown on the working drawings. The helical pile sections shall be engaged and advanced into the soil in a smooth, continuous manner at a rate of rotation of 5 to 20 RPM's. Extension sections shall be provided to obtain the required minimum overall length and installation torque as shown on the working drawings. Connect sections together using coupling bolt and nut torqued to 40 foot-pounds.
3. Sufficient down pressure shall be applied to uniformly advance the helical pile sections approximately 3 inches per revolution. The rate of rotation and magnitude of down pressure shall be adjusted for different soil conditions and depths.

F. Termination Criteria.

1. The torque as measured during the installation shall not exceed the torsional strength rating of the central steel shaft.
2. The minimum installation torque and minimum overall length criteria as shown on the working drawings shall be satisfied prior to terminating the helical pile.

3. If the torsional strength rating of the central steel shaft and/or installation equipment has been reached prior to achieving the contractor specified minimum overall length required, the Contractor shall have the following options:
 - a. Terminate the installation at the depth obtained subject to the review and acceptance of the helical pile design representative.
 - b. Remove the existing helical pile and install a new one with fewer and/or smaller diameter helical plates. The new helix configuration shall be subject to review and acceptance of the Engineer. If re-installing in the same location, the top-most helix of the new helical pile shall be terminated at least 3 feet beyond the terminating depth of the original helical pile. Shaft section shall not be reused after it has been permanently twisted during a previous installation.
4. If the minimum installation torque as shown on the working drawings is not achieved at the minimum overall length, and there is no maximum length constraint, the Contractor shall have the following options:
 - a. Install the helical pile deeper using additional extension sections, displacement plates, casing if required, and grout.
 - b. Remove the existing helical pile and install a new one with additional and/or larger diameter helical plates. The new helix configuration shall be subject to review and acceptance of the Engineer. If re-installing in the same location, the top-most helix of the new helical pile shall be terminated at least 3 feet beyond the terminating depth of the original helical pile.
 - c. De-rate the load capacity of the helical pile and install additional pile(s). The de-rated capacity and additional pile location shall be subject to the review and acceptance of the Engineer.
5. If the helical pile is refused or deflected by a subsurface obstruction, the installation shall be terminated and the pile removed. The obstruction shall be removed, if feasible, and the helical pile re-installed. If obstruction can't be removed, the helical pile shall be installed at an adjacent location, subject to review and acceptance of the Engineer.
6. The average torque for the last 3 feet of penetration shall be used as the basis of comparison with the minimum installation torque as shown on the working drawings. The average torque shall be defined as the average of the last three readings recorded at 1 foot intervals.

Method of Measurement.

Helical Pile will be measured for all Helical Piles engineered, furnished and installed as a lump sum unit.

Basis of Payment.

For all Helical Piles engineered, furnished and installed, the Contractor will be paid the lump sum contract price. This payment shall be full compensation for furnishing all design, materials, tools, equipment, labor and supervision, and installation techniques necessary to install Helical Piles complete as detailed on the plans, including connection details.

7. Construction Document Preparation

Construction documents should provide the information necessary to accurately design and install the helical piles. In addition to the specifications discussed in the previous chapters, the plan documents should include several key sections respective to the inclusion of helical piles. Descriptions of these sections are provided below along with examples of each section, courtesy of a past project completed by the Iowa DOT (2018a, 2018b). The sections include the following:

- Summary of Foundations (see Figure 12)
- Longitudinal Section Along the Centerline of Bridge (see Figure 13)
- Pile notes (see Figure 14)
- Abutment and pier plans and section cuts (see Figure 15)
- Soil borings (see Figure 16)

The summary of foundations in the previous Figure 12 provides the location, substructure type, and foundation type. Where piles are called for (in this case helical piles), the total number of piles, pile length, and total planned linear feet of helical piles per location are provided. As mentioned in previous chapters, the length is based on calculations performed using the site soils investigation information, pile type, and pile size. The actual installed length may vary from plan documents and will be determined during pile installation through the torque ratios of the installation equipment.

With respect to helical piles, a longitudinal section along the centerline of the bridge establishes the pile type and footing elevations and generally shows the configuration of the superstructure relative to the substructure components.

Pile notes should refer to the helical pile specifications or special provisions that accompany the plan set. These documents give the design requirements, materials, tools, equipment, labor and supervision, and installation techniques necessary to install the helical piles. Furthermore, the plan notes should include the vertical and horizontal design loads for the substructure components (abutments and piers) or individual piles for proper pile design. Estimated bearing depth and soil strata locations of the pile helices should be indicated along with any minimum depth requirements. Lateral force resolution requirements and maximum lateral deflection limits should also be noted.

The substructure plan view and section cuts provide specific dimensional information for the placement and layout of the helical piles and the location/elevation of pile termination within the abutment or pier footing.

Finally, soil boring logs from the site soils investigation should be provided so that the designer and contractor have an accurate picture of the soil strata into which the helical piles will be installed. This information will directly inform the pile design process and will be used by the installer as a reference to determine final pile depth and capacity.

SUMMARY OF FOUNDATIONS					
LOCATION	SUBSTRUCTURE TYPE	FOUNDATION TYPE	NUMBER	LENGTH (LIN. FT.)	TOTAL (LIN. FT.)
SITE 1 - SOUTH ABUTMENT	STUB ABUTMENT	HELICAL PILE	3	45±	135±
SITE 1 - NORTH ABUTMENT	STUB ABUTMENT	HELICAL PILE	3	45±	135±
SITE 2 - SOUTH ABUTMENT	STUB ABUTMENT	HELICAL PILE	3	45±	135±
SITE 2 - NORTH ABUTMENT	STUB ABUTMENT	HELICAL PILE	3	45±	135±

Iowa DOT

Figure 12. Example of summary of foundations

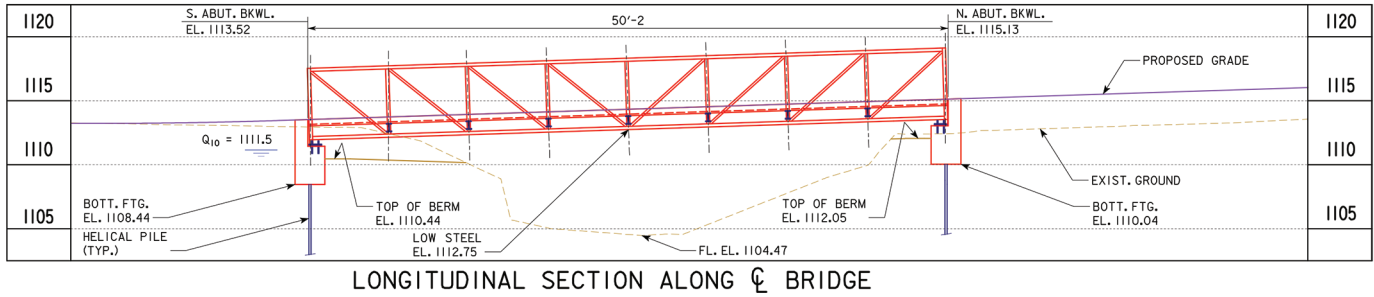

Iowa DOT

Figure 13. Example of longitudinal section along the centerline of bridge

PILE NOTES:

THE DESIGN AND CONSTRUCTION OF THE HELICAL PILE SHALL CONFORM TO SPECIAL PROVISIONS FOR HELICAL PILE.

ABUTMENT LOADING IS PROVIDED IN THE TABLES BELOW.
(TOTAL PER ABUTMENT)

LOAD CASE	VERT. (k)	HORIZ. (k)
STRENGTH I	77.6	2.5
STRENGTH II	70.6	2.5
STRENGTH III	54.0	7.3
STRENGTH IV	56.4	2.5
STRENGTH V	72.6	3.2

LOAD CASE	VERT. (k)	HORIZ. (k)
SERVICE I	56.6	2.9
SERVICE II	60.4	2.5
SERVICE III	51.6	2.5
SERVICE IV	41.1	4.2

ESTIMATED BEARING DEPTHS OF 40 TO 45 FEET BELOW THE SURFACE ELEVATIONS AT THE SOIL BEARING LOCATIONS TO BEAR IN MEDIUM DENSE TO DENSE SAND IS EXPECTED. MINIMUM TIP DEPTH OF 40 FEET IS REQUIRED TO ENSURE ALL HELIX PLATES ARE BEARING BELOW THE VERY SOFT AND SOFT CLAY IDENTIFIED ON THE BORING LOGS.

PILE DESIGNER SHALL SPECIFY AN INSTALLATION ANGLE UP TO 5 DEGREES FROM VERTICAL TO RESOLVE LATERAL LOADS AND MAINTAIN ANTICIPATED DEFLECTIONS OF 1/2 INCH OR LESS.





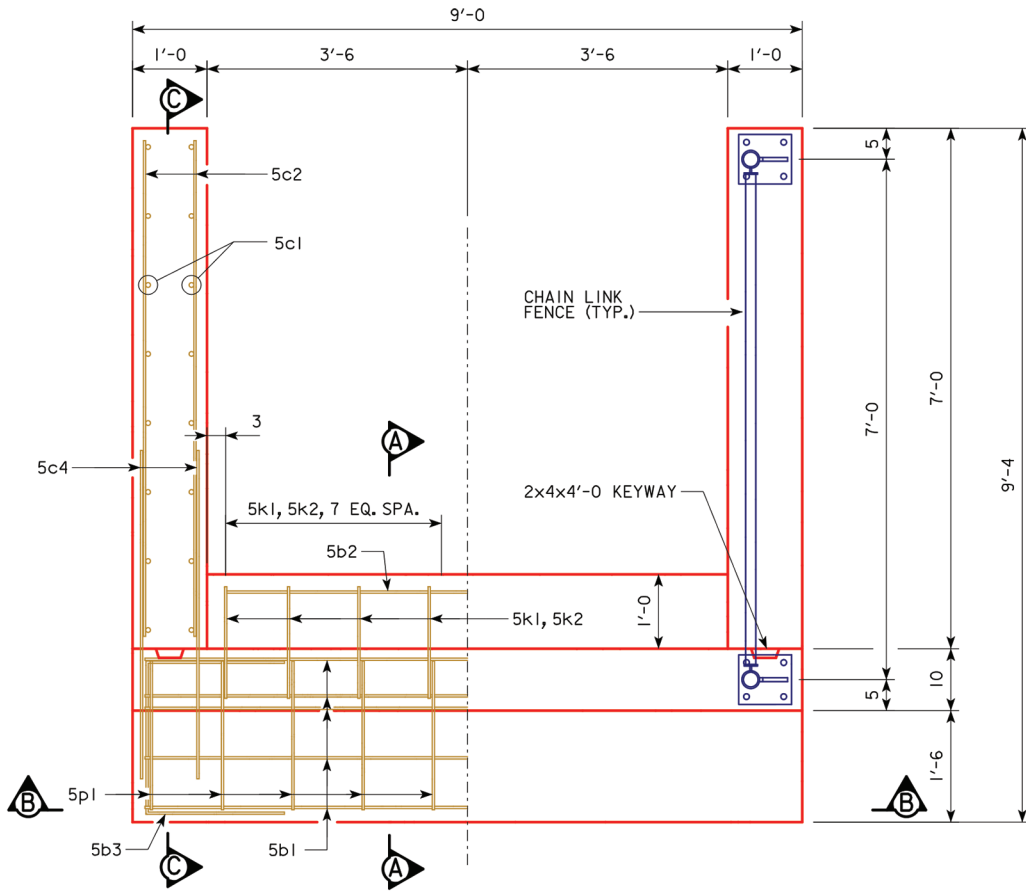



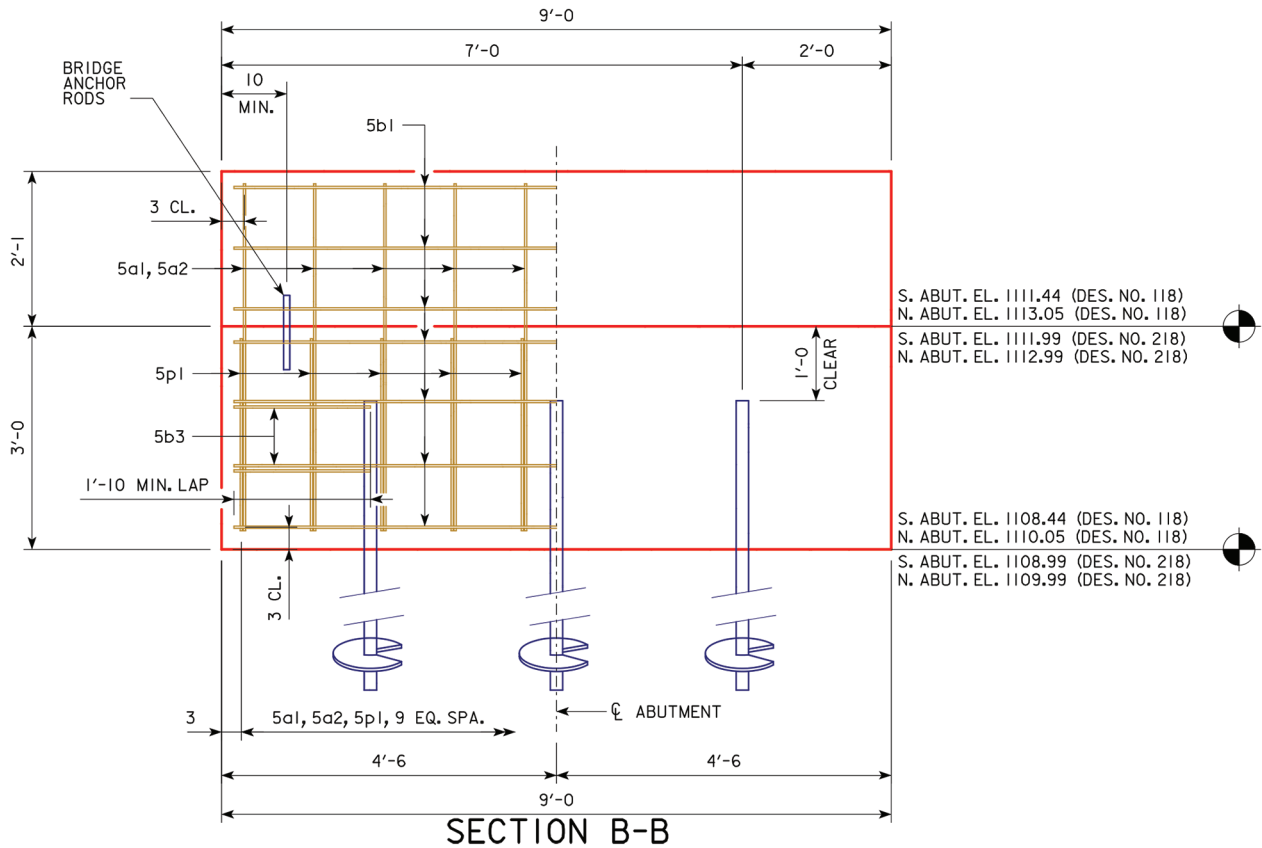







Iowa DOT

Figure 14. Example of pile notes



PLAN VIEW OF ABUTMENT



BORING LOG NO. 1									
Project: Bridge				Client: Bridge Owner					
Site: Anytown, USA									
Graphic Log	Location	Depth (ft.)	Water Level Observations	Sample Type	Field Test Results	Sample ID	Water Content (%)	Dry Weight (pcf)	Atterberg Limits
	Approx. 3 inch root zone								
	FILL - SANDY LEAN CLAY, with gravel, gray with brown to gray, stiff to very stiff, occasional sand seams	5			3-2-2, N=4	1	17		
						2	21	75	
	SANDY LEAN CLAY, trace gravel, gray with brown to gray, stiff to very stiff, occasional sand seams	10			3-2-2, N=4	3	13		
						4	12	114	
		15			3-4-6, N=10	5	13		
		20			3-5-8, N=13	6	13		
		25			3-5-9, N=14	7	12		
	becoming very stiff at about 24 feet	30			5-9-11, N=20	8	12		
		35			7-10-11, N=21	9	13		
		40			3-7-9, N=16	10	10		
					6-8-12, N=20	11	12		
Boring Terminated at 44.5 ft									
Advancement Method:				Notes:					
Water Level Observations				Bridge Geotech. Inc					

BEC

Figure 16. Example of soil boring log

References

- AASHTO. 2020. *AASHTO Load and Resistance Factor Design (LRFD) Bridge Design Specifications*. 9th edition. American Association of State and Highway Transportation Officials, Washington, DC.
- AISC. 2016. *ANSI/AISC 360-16: Specification for Structural Steel Buildings*. American Institute of Steel Construction, Chicago, IL.
- CHANCE. 2022. HeliCAP Helical Capacity Design Version 3.0 [Computer Software]. Retrieved from <https://www.hubbell.com/chancefoundationsolutions/en/resources/helicap-software>.
- Chance/Atlas. 2018. *Technical Design Manual*. Edition 4. Hubbell Power Systems, Inc. Centralia, MO.
- Cerato, A. B., T. M. Vargas, and S. Allred. 2017. A Critical Review: State of Knowledge in Seismic Behaviour of Helical Piles. *Deep Foundations Institute (DFI) Journal*, Vol. 11, No. 1, pp. 39–87.
- DFI. 2019. *Helical Pile Foundation Design Guide*. First Edition. Deep Foundation Institute, Hawthorne, NJ.
- Elsawy, M. K., M. Heidari, M. H. El Naggar, and A. B. Cerato. 2017. Interpretation of Seismic Response Data from Full Scale Helical Pile Tests. *DFI 42nd Annual Conference on Deep Foundations*, October 24–27, New Orleans, LA.
- Elsawy, M. K., M. H. El Naggar, A. B. Cerato, and A.W. Elgamal. 2019. Seismic Performance of Helical Piles in Dry Sand from Large-Scale Shaking Table Tests. *Geotechnique*, Vol. 69, No. 12, pp. 1071–1085.
- Ensoft Inc. 2022. LPILE 2022. <https://www.ensoftinc.com/products/lpile/>.
- Hoyt, R. M. and S. P. Clemence. 1989. Uplift Capacity of Helical Anchors in Soil. *Proceedings of the 12th International Conference on Soil Mechanics and Foundation Engineering*, Rio de Janeiro, Brazil, Vol. 2, pp. 1019–1022.
- ICC. 2009. *International Building Code (IBC)*. International Code Council, Washington, DC.
- . 2021. *International Building Code (IBC)*. International Code Council, Washington, DC.
- ICC-ES. 2007, 2016, 2020. *AC308 Acceptance Criteria for Helical Pile Foundations and Devices*. International Code Council Evaluation Service, Washington, DC. <https://icc-es.org/acceptance-criteria/ac308-2/>.
- Iowa DOT. 2018a. *Special Provisions for Helical Pile*. Project: Harrison County NHSN-030-1(161)—2R-43.
- . 2018b. *Final Design Plan Set*. Project: Harrison County NHSN-030-1(161)—2R-43.
- Pack, J. S. 2000. Design of Helical Piles for Heavily Loaded Structures. *Geo-Denver 2000: New Technological and Design Developments in Deep Foundations*, August 5–8, Denver, CO, pp. 353–367.
- Perko, H. A. 2004. *Introduction to Corrosion and Galvanizing of Helix Foundations*. In Proceedings of the Helical Foundations and Tie-Backs Specialty Seminar, Deep Foundation Institute, Tampa, FL.
- . 2009. *Helical Piles: A Practical Guide to Design and Installation*. John Wiley and Sons, Hoboken, NJ.
- Ram Jack. 2022. Helical Pile Design Software. <https://www.ramjack.com/commercial/engineer-resources/design-software/>.

