



800 Lincoln Way | Ames, Iowa 50010
515-239-1101 | www.iowadot.gov

Iowa

Moped Operator's Manual



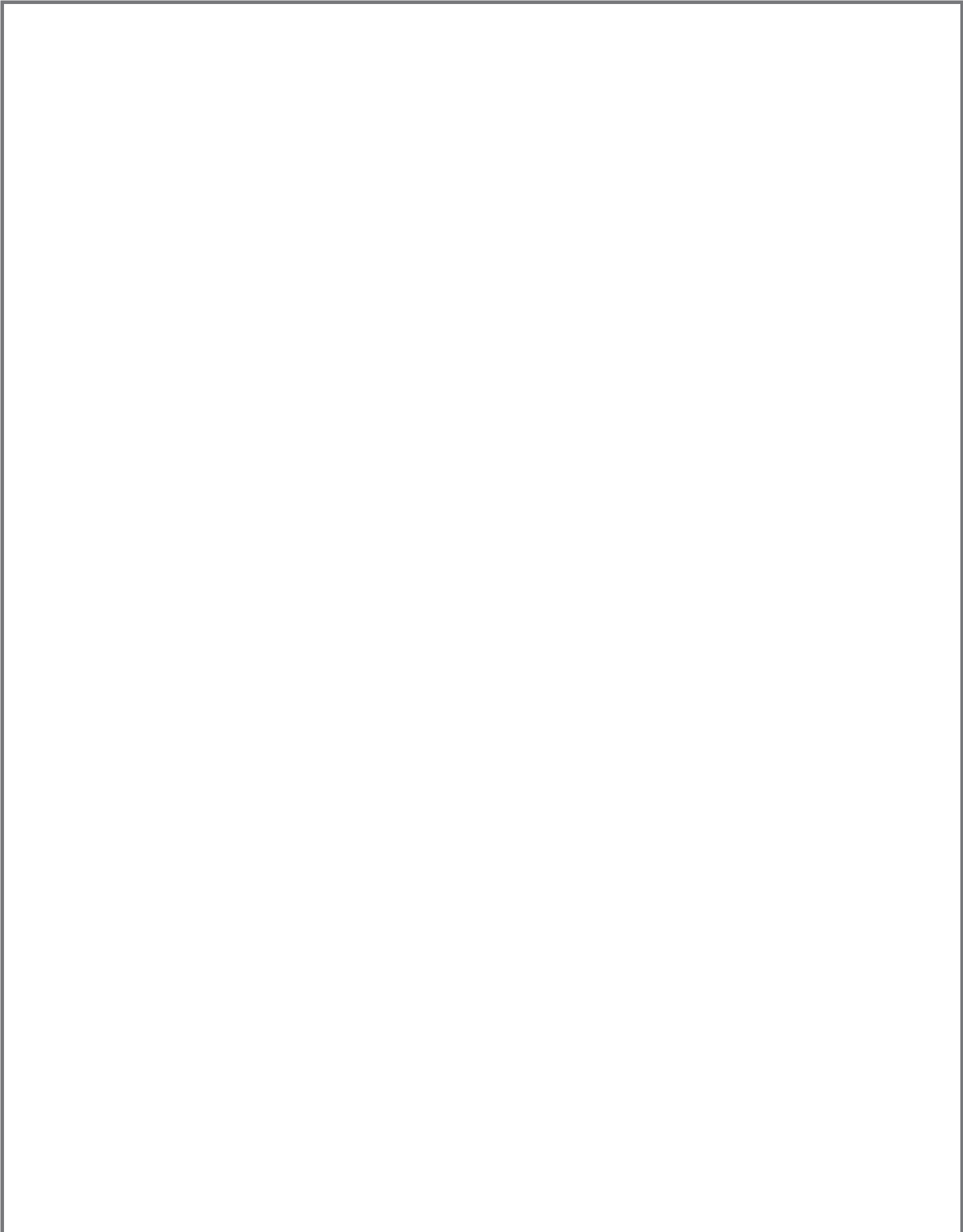

CONTENTS

1. Introduction	1
2. Mopeds and Iowa law	2
3. Responsibility	4
4. Check it before you wreck it.....	6
5. Controls	10
6. Master the skills	12
7. Traffic signs and signals	15
8. Distance detection	24
9. Visibility	26
10. Hazards.....	27
11. Impaired driving	29
12. Enjoy the ride	30
Glossary of terms	31
Final exam	32
Driver's license content.....	36

Congratulations! on embarking upon the wonderful world of two-wheeled transportation, which includes mopeds. You are going to have a marvelous time.

You also have some new responsibilities, which are introduced in the following pages. However, this booklet provides only basic information, as there are a variety of makes and models of mopeds. Refer to your moped owner's manual for information about specific features and controls.

Mopeds have increased in popularity in recent years. Along with this increase comes the need to emphasize safety.

Your safety while operating a moped depends on mastering not only the skill of riding, but also the realities of mixing with the traffic around you.

The time you spend understanding this information may be the most valuable investment you make toward your safety and enjoyment while operating your moped.

The information contained in this publication is offered to benefit those with an interest in mopeds and moped riding. In addition, the Iowa Department of Transportation provided materials and supplemental materials from publications, interviews and observations of individuals and organizations familiar with the use of mopeds and training methods. Because there are many differences in product design; riding styles; and federal, state and local laws, there may be organizations and individuals who hold differing opinions. Consult your local Iowa DOT's driver's license issuance site staff for clarification of elements that you do not understand. Although the Iowa DOT will continue to research and update the materials offered in this course, it cannot guarantee the safety of the operation, maintenance and street use of your moped.

It is recommended you take a moped safety course before operating your moped. **If you are at least 14-years-old, but under age 16, a moped safety course is required by law. (See page 2 for licensing requirements.)** The following contains a list of Iowa community colleges that offer moped safety courses.

Iowa community colleges licensed to provide moped safety courses		
College name	City	Telephone number
Northeast Iowa Community College	Peosta	563-556-5110 ext. 372
Northwest Iowa Community College	Sheldon	800-352-4907
Iowa Central Community College	Fort Dodge	515-574-1967
Eastern Iowa Community College	Davenport	563-441-4100
Kirkwood Community College	Cedar Rapids	319-398-7130
Des Moines Area Community College	Ankeny	515-964-6676
Western Iowa Tech Community College	Sioux City	712-274-8733 ext. 1821
Southeastern Community College	Burlington	319-208-5384
Iowa Lakes Community College	Estherville	800-252-5664
Hawkeye Community College	Waterloo	319-296-2320
North Iowa Area Community College	Garner	515-923-2252
Southwestern Community College	Creston	515-782-1424
Iowa Western Community College	Council Bluffs	712-325-3415
Iowa Valley Community College	Marshalltown	641-844-5608

The most current and comprehensive list of moped safety courses is available at <http://www.iowadot.gov/mvd/motor-cycle/moped.html>

I. INTRODUCTION

Moped safety course topics include the following.

- Introduction to mopeds
- Risk awareness
- Risk acceptance
- Risk management
- Crash factors
- Operator's gear
- Preride inspection
- Routine maintenance
- Getting on/off the moped
- Engine starting and stopping procedure
- Moped operation
- Moped operation on the streets
- Collision avoidance skills
- Hazards
- Alcohol use

Successfully completing a moped course is not a guarantee that you will be safe on the road. Only you can determine your level of safety through the choices you make as an operator. This course provides opportunities to acquire the basic knowledge for developing good operating habits.



2. MOPEDS AND IOWA LAW

2a: Moped characteristics

In Iowa, a “motorized bicycle” or moped is defined as a motor vehicle:

- Having a saddle or seat for the use of a single operator (no passengers).
- Designed to travel on not more than three wheels in contact with the ground.
- Incapable of operating at a speed in excess of 39 mph on level ground unassisted by human power.
- Able to travel at a speed of at least 20 mph while driving up a 3 percent incline.

If a motor vehicle is unable to meet all of the above characteristics, it may not be licensed as a moped.

2b: Licensing requirements

Moped license – Restriction 5

If you are 18 years old or older and have never had a driver’s license, you will need to pass the vision screening and knowledge test. You may also have to take a skills test to show you can properly operate a moped. Additional licensing is not required if you possess a valid driver’s license.

To get a moped license you must be at least 14 years old, pass the vision screening and knowledge test, and present a parental consent form, along with proof of age and identity. Visit www.iowadot.gov/mvd/realid/success.html to build a personal checklist of the documents you will need to satisfy Iowa’s identification requirements. If you are under 16 years old, you must pass an approved moped education course to get a moped license.

Sample of a Moped Manufacturer’s Label

MANUFACTURED BY: MANNY’S MOPEDS
July 2007
GVWR 271 KG (598 LB)
GAWR FRONT 110 KG (243 LB) WITH M 120/70R18 TIRE, 18XMT3.00 RIM. AT 250 KPA (36 PSI) COLD
GAWR REAR 161 KG (355 LB) WITH M160/60R17 TIRE, 17XMT4.00 RIM. AT 250 KP A (36 PSI) COLD
THIS VEHICLE CONFORMS TO ALL APPLICABLE U.S. FEDERAL MOTOR VEHICLE SAFETY
STANDARDS IN EFFECT ON THE DATE OF MANUFACTURE SHOWN ABOVE
VIN: WMIXXXXXXXXXXXXXX TYPE: MOPED

If you are 16 years old or older and have never had an Iowa driver’s license, you must pass the vision and knowledge test. If you are under 18 years old, you will also need to present a parental consent form, along with proof of age and identity.

2c: Registration and insurance

Any motor vehicle registered in Iowa must have a manufacturer’s certification stating the vehicle meets federal motor vehicle safety standards. Without a manufacturer’s certification label, vehicles cannot be titled or registered. You will be required to register your moped with your county treasurer’s office and display your license plate on the rear of your moped.

Anyone operating a motor vehicle registered in Iowa must carry proof of insurance with them at all times, including moped operators. Failure to do so could result in fines and possible impoundment of your vehicle.

With some insurance companies, the better your driving record, the less your insurance will cost. You may even qualify for a discount on your rate just by taking this course. Be sure to ask your insurance carrier.

2d: Laws specific to mopeds

In addition to following all basic traffic rules and regulations, moped operators are responsible for knowing and abiding by the following laws specific to mopeds.

- Mopeds are designed to carry one person; passengers are not allowed.
- A moped must be equipped with a day-glow orange safety flag that extends no less than 5 feet above the ground and is attached to the rear of the moped. The safety flag must be triangular in shape with a surface area no less than 30 square inches.
- Mopeds should not be operated side by side in the same lane of travel.
- Mopeds must not be operated between lanes of travel, or adjacent lines or rows of vehicles.
- All mopeds must have a lighted headlight at all times when being operated on a public street or roadway.



The Iowa Driver's Manual should be used to study for the operators exam and is available at all driver license issuance sites or can be accessed online at: www.iowadot.gov/mvd/driverslicense/dlmanual.htm

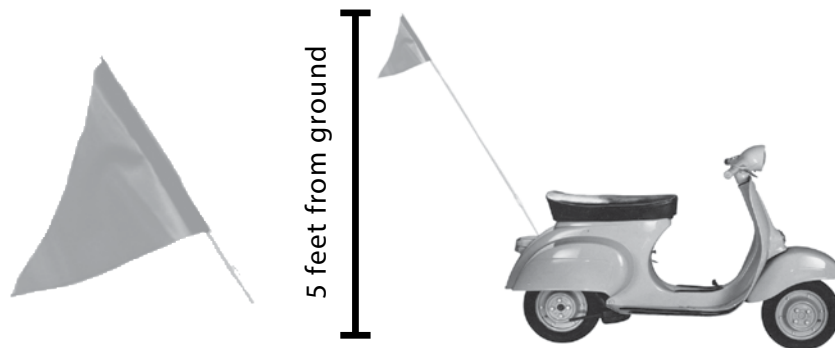

- Moped operators must not carry a package, bundle or other article that prevents the operator from keeping both hands on the handgrips.

Be sure to securely strap down and center any cargo you carry on your moped. Avoid obstructing the view of any lights or signals. Keep the cargo and straps away from hot or moving parts. Remember, heavier cargo will affect how your moped operates and you will need to compensate for the additional weight.

3. RESPONSIBILITY

3a: Risk awareness

Operating any motor vehicle on Iowa's streets and roadways is a big responsibility and accompanies a certain amount of risk. This is especially true for moped operators. Certain characteristics of mopeds present unique safety concerns for their operators.

One of the biggest challenges facing moped operators is stability. Unlike cars and trucks, mopeds operate on two wheels and weigh less, making them more susceptible to riding conditions, such as wind or wet pavement. It is important for moped riders to remain constantly aware of their balance and the conditions around them.

Physical vulnerability is another concern for moped operators. Mopeds provide very little protection for their operators. Wearing proper protective gear is the best way to ensure your safety if a crash should occur.

The final thing to keep in mind while operating your moped is visibility. Mopeds are much smaller and can be more difficult for other road users to see. It is imperative that moped operators keep this in mind and use good lane positioning to increase visibility to other vehicle operators.

When considering the risks of operating your moped, it is important for each individual to consider his or her riding experience and level of skill. Do not put yourself in situations that exceed your experience and comfort level.

Operating a moped is a big responsibility; one that is not to be entered into lightly. The decisions you make while operating your moped will affect the rest of your life and the lives of others. It is important to remember that not all risks are due to the moped operator's own behavior – defensive driving skills and driver courtesies are very important to the safe and enjoyable use of your moped. Safety in traffic is a responsibility shared by all road users.

3b: Risk acceptance

Some people are willing to take more risks than others. If you choose to operate a moped, you must recognize and accept the additional risks. Once you become aware of the risks associated with moped riding and accept them, it is time to learn how to manage those risks. Following the risk management techniques taught in this course allows moped operators to learn how to lessen the chances of a crash and how to limit, whenever possible, the severity of crashes that do occur.

3c: Risk management

What is your definition of a "good moped operator"? First and foremost, a good moped operator must demonstrate awareness of the risks and a desire to reduce them. This person should also possess superior operating skills, know and obey the laws, use safety gear while riding, put visibility techniques into practice, and watch what is happening around them.

A good moped operator must think safety and ride according to his or her own skill level, road conditions and vehicle capabilities.

A simple and helpful strategy is the SEE principle: Search, Evaluate, Execute. To SEE is to search for factors that might lead to trouble, evaluate how the factors might interact to create risk, and execute an action to maintain safety. (SEE will be covered later in this guide.)

3d: Crash factors

Crashes do not just happen. They are the result of a chain of events and circumstances caused by either the operator, moped, other traffic, road conditions, or environment. It is helpful to understand why moped crashes occur. Individual factors can include speeding, inattention, distraction, drinking and/or carelessness. However, studies indicate that most crashes are caused by multiple factors.

Review questions

1. Who is responsible for safety?
2. List three characteristics that define a moped.
3. Describe a crash discussed by your group (or any crash that you are aware of) and briefly describe the circumstances. What preventive measures could have been taken?
4. What is the minimum age for being licensed to drive a moped?
5. What paper must you carry with you when you ride?
6. What is one difference between mopeds and cars?
7. What must happen before risks can be managed?
8. What are three characteristics that might define a "good moped operator"?
9. What strategy will be helpful for the moped operator to search for factors that may lead to trouble?
10. Crashes are caused by what?

4. CHECK IT BEFORE YOU WRECK IT

Check it before you wreck it. There are three things you need to check every time before operating your moped:

1. **Yourself.**
2. **Your moped.**
3. **Your gear.**

4a: Check yourself

It is clear what it means to check your moped and your gear, but you may be wondering about checking yourself. Checking yourself means evaluating your physical health, state of mind and any other factors that could interfere with safely operating your moped. Did you get enough sleep? Are you taking any medications that affect your mental state? Common, over-the-counter and prescription medications can make you too drowsy to safely operate your moped. Consult the label of any medication you are taking before operating your moped.

How is your emotional state? Feelings such as anger, worry, distraction, depression, anxiety, fatigue and stress distract your focus from where it needs to be – on safety.

4b: Check your moped

Get to know your moped. It is very different from a car. Preride inspections help ensure that your moped is ready to go, providing confidence that the vehicle will operate and respond properly. Get to know your moped owner's manual as well – not all mopeds are alike. The owner's manual will provide specifics you will find helpful in understanding and maintaining the make and model you have chosen. Each time you ride, it is important to do a basic equipment inspection. Use the **T-CLOCS** acronym to help you remember what to check.

- Tires and wheels
- Controls
- Lights and electronics
- Oil and other fluids
- Chassis
- Stand (side or center)

T-CLOCS Inspection

T – Tires and wheels

- Air pressure
- Tread
- Cracks, dents, loose spokes
- Bearings
- Brakes

C – Controls

- Levers
- Switches
- Cables
- Hoses
- Throttle

L – Lights and electronics

- Working condition

O – Oil and other fluids

- Levels
- Leaks

C – Chassis

- Suspension
- Drive components (chain, belt or drive shaft)
- Cracks, dents, loose spokes
- Bearings
- Brakes

S – Stand (side or center)

© Checklist courtesy of MSF, all rights reserved

T – Tires and wheels

Starting with the tires and wheels, check air pressure, tire tread, cracks or dents in the wheel, loose spokes, wheel bearings and brakes.

C – Controls

Next, check the controls. Check all levers for smooth operation and proper function. Inspect visible cables and hoses for obvious damage and secure connections. Confirm that the throttle is working properly.

L – Lights and electronics

When inspecting the lights, ensure that the headlight, low and high beam, works properly. Also test the brake lights, turn signals and taillights. Make sure the gauges and indicator lights are working, including the horn.

O – Oil and other fluids

Check engine oil and fuel.

C – Chassis

On the chassis, check the front and rear suspension by gently rocking the moped back and forth. Check the drive component of your moped, which could be a chain, belt or drive shaft.

S – Stand

Finally, do not forget the stand. Your moped may be equipped with a side or center stand. When you take the moped off its stand, be prepared to control the moped's balance. Make sure the stand is completely up before you ride away and completely down before you dismount.

Routine maintenance

Mopeds require maintenance beyond the basics listed above. Your moped owner's manual is the best source for information about inspection and maintenance details. Routine maintenance can make your machine safer and less expensive to operate. Maintenance helps avoid breakdowns and costly repairs. In addition, keeping your moped clean increases visibility and prevents dirt from covering or hiding a serious problem. However, always carry a tool kit with you for those occasional bolts or screws that might come loose while you are on a ride.

4c: Check your gear

The final thing you need to check before operating your moped is your gear. On a moped, the only thing separating you from the pavement is what you wear, your personal protective gear. It provides safety, comfort and protection in the event of a crash.

Every rider should wear the following when riding a moped.

- Over-the-ankle footwear
- Long pants
- A jacket or long-sleeve shirt
- Full-fingered gloves
- Protective eyewear
- A helmet that meets U.S. Department of Transportation standards

Helmets

There are several different styles of helmets to choose from. A full-coverage helmet will provide the most protection, while a three-quarter helmet leaves your face, teeth and chin exposed. When buying a helmet, make sure it fits properly. It is easy to determine a proper fit. The helmet should fit snug without feeling uncomfortable, and you should not be able to roll the helmet off your head once the chinstrap is fastened. Always fasten the chinstrap. If the helmet is not secure, it will not offer protection when it counts.

To identify a quality helmet, look for a DOT sticker to make certain the helmet meets DOT safety standards.



There are four basic components of a DOT-approved helmet.

1. Outer shell
2. Impact-absorbing liner
3. Comfort padding
4. Retention system

The outer shell is often made of fiberglass or molded plastic. It is designed to keep sharp or hard objects from penetrating the head. The outer shell becomes damaged once impacted. The damage can be invisible to the human eye, so if the helmet falls or takes an impact, it should be replaced.

The liner is usually made of impact-absorbing polystyrene. This layer cushions and absorbs the shock. The outer shell and liner work together to offer protection. The more impact energy that is deflected or absorbed, the less there is to reach the head and brain.

The comfort pad is the soft foam and cloth layer next to the head.

The retention strap, or chinstrap, is very important. It keeps the helmet on your head if a crash should occur. If your helmet is not secure, it may fall off.

Head injuries account for a significant number of serious injuries and fatalities. Wearing a helmet is of the utmost importance.

Protective eyewear

If your helmet is not equipped with a face shield, you will want to wear some type of protective eyewear. Riding goggles, worn outside your helmet, work great, or you can invest in protective eyewear designed to look just like stylish sunglasses. Ordinary glasses or sunglasses



are no match for the elements you will encounter: wind, rain and big, fat juicy bugs. If an object hits your eye, it could cause permanent damage. Remember, tinted shields or lenses are for daytime use only.

Gloves

Gloves designed for moped riders can protect you from a number of hazards. They offer protection from wind, rain, heat, cold and objects kicked up by other vehicles on the roadway. They will also give you a better hold on your handgrips.



Jacket/Long-sleeve shirt

Jackets designed specifically for riding are made from durable material; such as leather or denim. Leather offers you the most protection when it comes to abrasion. Garments designed to fit while sitting are cut longer in the sleeves and will help keep the wind out. Remember, even in warm temperatures, constant exposure to wind may cause hypothermia. Hypothermia is a subnormal body temperature and can cause loss of concentration and slowed reaction.



When choosing a jacket or any riding gear, select bright colors and garments with retroreflective material to become more conspicuous to other road users. If riding gear is too expensive, apply retroreflective tape to your clothing or wear a strong yellow-green vest, like those worn by road workers.

Pants

Pants protect or minimize abrasion in a crash. Riding pants, as shown, work best. At minimum, wear pants made from denim or other thick materials. Avoid wearing wide-flared pants that can flap in the wind and possibly become entangled in your moped's moving parts.



Footwear

Rugged over-the-ankle footwear is recommended. A leather boot can provide you with a good grip on the roadway and protect you from hot parts if you crash with your moped.



Rain suits

Anyone who rides a moped will likely get caught in the rain at one time or another. You will be much more comfortable if you are dry. One- and two-piece style rain suits

are available. Rain suits made specifically for motorcycle/moped riding are the most appropriate. Wind can tear or shred ordinary rain suits. If possible, choose a bright color, such as orange or yellow, so surrounding traffic will have an easier time seeing you.



Review questions

1. Is the moped operator on the left or right following proper safety guidelines? Use the notes margin to write down the differences between the two operators. Be prepared to discuss your observations with the class.



2. What are the three things you should check every time before operating your moped?
3. What are the four basic components of a DOT-approved helmet? Why is wearing a helmet so important?
4. List the essential riding gear for operating a moped.
5. Explain what the acronym T-CLOCS stands for.

5. CONTROLS

Part of being a good moped operator is understanding the different controls your moped is equipped with and how those controls function and interact to give you a smooth ride. Like any other motor vehicle, your moped has controls for steering, accelerating and stopping.

5a: Primary controls

In addition to the handgrips, mopeds are equipped with three other primary controls, which are listed below.

- Throttle
- Rear brake
- Front brake

All of the primary controls are located on the moped's handgrips.

Throttle

The throttle, usually found on the right handgrip, twists toward the rider to supply power and away from the rider to slow down or stop. A centrifugal

clutch supplies the moped with power, causing a delayed reaction to acceleration. In simple terms, the engine RPM needs to increase to a required minimum level before the clutch will engage and moped move forward.

Brakes

The braking system on a moped is similar to that of a bicycle. The rear brake is located on the left handgrip, and front brake is located on the right handgrip. The front brake supplies the majority of the moped's stopping power. However, both brakes should be used every time to stop the moped. Using both brakes is called **maximum braking action** and is a good skill to practice.

5b: Other controls

The following is a sample diagram showing moped parts. Remember, this is only a sample. Each moped is unique and the location of parts varies from one moped to another. Consult your moped owner's manual to obtain accurate information that is specific to your moped.

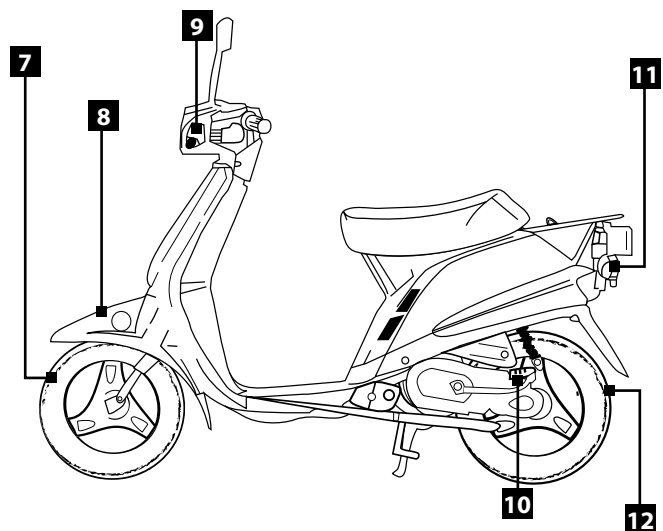
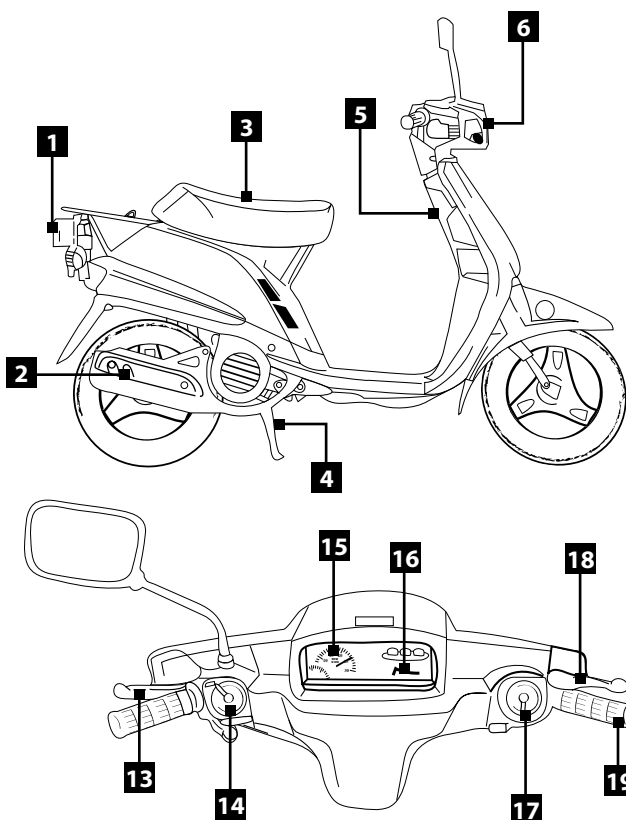

- | | |
|--------------------------|----------------------------|
| 1. Taillight/Brake light | 11. Rear flasher light |
| 2. Muffler | 12. Rear wheel |
| 3. Seat | 13. Rear brake lever |
| 4. Center stand | 14. Left handlebar switch |
| 5. Main switch | 15. Speedometer |
| 6. Headlight | 16. Fuel gauge |
| 7. Front wheel | 17. Right handlebar switch |
| 8. Front fender | 18. Front brake lever |
| 9. Front flasher light | 19. Throttle grip |
| 10. Kick starter | |

Ignition

On most mopeds, the ignition switch or button is located near the primary controls on the handgrips. Customarily, the ignition switch has three settings: on or run, off and lock.

Gauges

The gauges are located on the dash of your moped. The speedometer displays the speed your moped is traveling, and the odometer records the total distance the moped has traveled. Your moped may also be equipped with a trip odometer, which can be reset and used to determine gas mileage. The fuel gauge displays the amount of fuel. Never let your moped get too low on fuel. It could cause damage to your moped's engine/motor.

Lights

Your moped's indicator lights, also located on the dash, alert the driver to various operating conditions, such as low oil pressure, or turn signal activation.

Signals

Turn signals are usually found on the left handgrip and should be operated with your left thumb. Always signal your intentions and remember to cancel your signal once the maneuver is completed.

Customarily, the headlight switch is also found on the left handgrip above the turn signals – high beam for night or low visibility riding; low beam for daytime riding.

Horn

The horn is also located on the left handgrip and should be operated with your left thumb.

Electric start

The moped's electric start button is located on the right handgrip. It is operated with the right thumb.

Stand

The moped's stand may be located at the side or center of the moped and is used to support the moped when it is parked.

Take the time to become familiar with your moped. Your safety depends on your ability to operate your controls without taking your eyes off the road.

Review questions

1. Name the primary controls on a moped.
2. What should you refer to if you have questions about your moped?

6. MASTER THE SKILLS

Becoming a good moped rider involves more than knowing the controls and functions of your moped. It is a great start, but you must also have the skill it takes to perform those functions precisely and automatically. The only way to master the basic skills of moped riding is through practice.

You should practice basic skills in a safe environment where there is little or no traffic. Remember, motor skills are best gained through practice and experience. Think about the first time you learned to ride a bicycle. In the beginning you had to concentrate on balance, steering and pedaling all at once. After enough practice, you could perform all those tasks in perfect harmony without thinking about the individual components. The same is true for learning to ride a moped, only if you make a mistake or choose to ignore the fundamentals, the consequences could be much more severe than a scrapped knee.

When you begin to ride your moped, you will need to remember the following motor skill principles.

- Motor skills are best acquired through practice and experience – not forced.
- Too much verbal information hinders learning.
- Beginning riders should focus on technique before speed.
- Get the big picture before fine-tuning the details.

6a: Posture

Sit so you can use your arms to steer the moped. You should sit far enough forward so your arms are slightly bent. Hold the handgrips firmly and keep your feet firmly positioned on the footrests or floorboard to maintain balance and have good control of your moped. Keep your head and eyes up, and look where you want your moped to go.

6b: Mounting

To get on your moped, squeeze the front brake that is on the right handgrip. While applying the brake, swing your right leg over the rear of your moped or through the center of the moped frame. Once seated, check all the levers and throttle to ensure they are working and properly adjusted for you.

6c: Starting the moped

Before starting your moped, turn the ignition switch or button to the “on” or “run” position to start the engine. Squeeze the rear brake as you press the start button.

Mopeds are equipped with a centrifugal clutch. If you increase the engine speed, power will be supplied to the rear wheel causing your moped to begin to move. This is called “blipping” the throttle. Blipping the throttle is unsafe and damages your moped.

6d: Accelerating

As your moped riding skills develop, your acceleration skills should also improve. Twisting the throttle gently will provide smooth acceleration and make your ride much more enjoyable. It is important to develop a smooth throttle because you will need that skill for making smooth turns.

6e: Turning

Unless you plan to ride in a straight line forever, turning is a skill every moped rider must master. The four steps to executing a proper turn are:

- First, **slow** to an appropriate speed before the turn.
- Second, **look** where you want your moped to go. This will allow you to have a smooth controlled path through the turn.
- Next, **press** forward on the handgrip in the direction you want your moped to go and lean your body slightly into the turn. This is a technique called **counter-steering**. Press left, lean left, go left. Press right, lean right, go right.
- Finally, **roll** on the throttle through the turn. This will help to stabilize your moped. The key to accomplishing the roll through the turn is to have your speed adjusted before you encounter the turn.

6f: Curves

Another must for any moped rider to learn is how to negotiate curves safely. Curves can be great fun on a moped, but pose a serious safety issue if executed

incorrectly. The majority of single-vehicle crashes for two- or three-wheeled vehicles occur on curves. Use the **slow, look, press** and **roll** technique to make turns.

6g: Maximum braking

Rear brake only

Front brake only

Both brakes

Maximum braking is used to stop quickly in an emergency and is one of the most important skills a moped rider can master. Always use both brakes to put your moped to the point of an impending skid, but without skidding.

Practice maximum braking so the skill is there when you need it.

You may be faced with the need to brake while negotiating a curve. Because some of the traction is lost in a curve, if possible, straighten the moped and then stop in a straight line.

6h: Skidding

If your front wheel locks, release the front brake immediately and re-apply. If you accidentally lock the rear brake on good traction, keep it locked and steer straight ahead until you have stopped completely.

6i: Swerving

Sometimes swerving is the best way to avoid a hazard. Swerving consists of two counter steers, one to avoid the hazard and the other to return to the original path. When swerving, keep your body upright. Never use swerving and braking together. If necessary to swerve and brake, complete one maneuver before attempting the other.

6j: Changing lanes and passing

Changing lanes on a moped is really no different from changing lanes while operating any type of vehicle on the roadway. Check your mirrors, glance over your left shoulder to cover your blind spot, and signal before moving into the opposite lane. You may need to accelerate, but should not exceed the speed limit. Passing is very similar to changing lanes. For both maneuvers, make sure you have enough time and space to change lanes or pass safely.

6k: Group riding

If you ride with others, do it in a way that promotes safety. Small groups are easier for other traffic to get around. Never operate directly alongside another rider. There is no place to go to avoid something on the road. A staggered formation maintains an adequate space cushion. Single file formation would be used when riding through curves, turning or exiting a highway.

6l: Stopping

For a smooth stop, roll off of the throttle as you squeeze both brakes. Using both brakes for “normal” stops will enable you to develop the proper habit or skill of using both brakes if you need to stop quickly. Remember to apply maximum braking for every stop.

6m: Parking

Park your moped so you can easily get out when you are ready to ride again. Parking is simple unless you are on an unfavorable terrain, such as loose gravel or soft dirt. Place a side stand puck or crushed soda can under your stand to stabilize your moped when parked.

6n: Dismounting

Dismounting is very similar to mounting. Squeeze the rear brake lever and swing your right leg over the rear of your moped or through the center of the moped frame. Using your engine cutoff to shut down your moped is a good habit to practice. Remember to turn the ignition switch to off.

Review questions

1. What is the four-step process for turning your moped?
2. Explain the counter-steering technique.
3. Why is it important to have good posture when riding your moped?
4. True or false. If you lock your rear wheel, you should keep it locked?
5. What three things should you do before changing lanes or passing a vehicle?
6. Why is it unsafe to ride side by side on your moped?

SIGNALS

There are traffic rules that govern where, when and how fast you can drive. These rules help to keep traffic moving safely. Rules of the road include traffic controls, lane controls, right-of-way laws and parking rules.

Traffic signs indicate traffic laws, hazards, where you are, how to get where you are going, and where services are located. The shape and color of these signs give clues to the type of information they provide.

Traffic controls include traffic signals, traffic signs and pavement markings. Traffic control can also be provided by law enforcement, highway personnel or school crossing guards. You must obey directions from these persons.

7a: Traffic signs

Standard colors



Red

Stop, yield or do what is shown on the sign.



Green

Direction. These signs tell where a place is located, or distance from where you are.



Blue

Services for travelers. These signs direct you to places such as rest areas, tourist sites, hospitals, hotels, gas stations, eating places, campgrounds or picnic areas.



Yellow

General warning.



Fluorescent yellow-green

Pedestrian, bicycle and school warning signs. This color is much easier to see in low light and foggy/rainy weather.

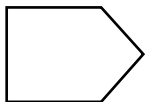

White

These signs tell you about regulations, enforceable laws and ordinances.



Orange

Road work and maintenance warnings. Be sure to watch for workers on the road.



Brown

Recreation and cultural points of interest. These signs point out historical sites, parks or recreational areas.

Standard Shapes



Octagon - stop

Come to a full stop at an intersection controlled by this sign. Stop at the marked stop line or before entering the crosswalk or before your vehicle enters the intersection. Let other vehicles or pedestrians pass if they are in your path.



Equilateral triangle

Yield the right of way. Slow down and let vehicles crossing your path go by. If necessary, stop before going ahead. If pedestrians are in or about to enter the crosswalk, stop until they have crossed the roadway, then proceed.



Pennant

This sign will be on the left-hand side of the road or highway. It warns you of a no passing zone.



Diamond

Warning. These signs alert you to special road hazards. Words or pictures on the sign will show you why you need to slow down or use extra caution.



Rectangle

Regulatory or guide. Vertical signs indicate what you should or should not do. Horizontal signs give directions or information about services drivers may want.



Pentagon

School crossing. Signs mark school areas and school crossings. The color of this sign may also be yellow.

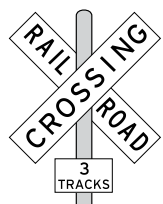

Crossbuck

Railroad crossing signs are placed at each crossing. A number sign under the crossbucks shows how many sets of train tracks you must cross.



Circle

Railroad crossing ahead. These signs give you early warning of railroad crossings.

7b: Warning signs

These signs are yellow with black lettering or symbols and most are diamond-shaped. These signs warn you to slow down and be prepared to stop if necessary; a special situation or hazard is ahead. Some common warning signs are shown below.

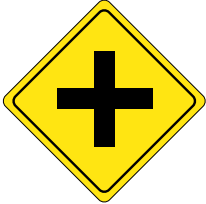

Intersection/Crossroad

There is another road ahead which crosses the road you are on. Watch carefully for cross traffic in your path.



Signal ahead

These signs are used on roads with higher speeds. Be ready for an intersection and a stop light.



Merging traffic

If you are on the main road and see this sign, be prepared for other cars and trucks merging into your lane.

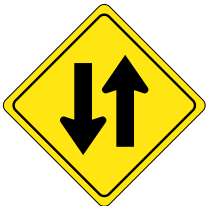

Two-way traffic

Keep to the right because you are leaving a one-way road and entering a two-way road.



Divided highway begins

You are getting close to the place where two-way traffic will be divided by a center strip.



Divided highway ends

Two-way traffic will no longer be divided by a center strip. Watch out for oncoming vehicles.



Merge left

Two lanes of traffic will soon become one lane of traffic. Right lane traffic must yield when merging.



Gradual right curve

Road ahead curves gradually to the right. Be prepared for the change in direction.



Farm machinery

Farm equipment may be crossing the road. Be ready to slow down for slow moving equipment.



Slippery when wet

Road ahead becomes slippery in wet weather. Slow down under these conditions.



Pedestrian crossing

Watch out for people who might walk or run in front of you.



Chevron sign

Used in addition to the curve signs when there is a need to draw added attention to a change in the road's direction.



Deer crossing

There may be deer attempting to cross the roadway in the area. Slow down and watch carefully.



Ramp speed

The recommended speed on an exit ramp.

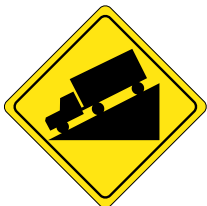

Hill

The sign is a warning to all vehicles that the road ahead goes down a hill. You should check your brakes before going down the hill.



Advance school crossing

You are nearing a school area with a crossing. Watch for children and the marked school crossing. The color of this sign may be yellow.



T-intersection ahead

The road you are on does not go straight ahead. Prepare to turn right or left.



School crossing

Watch out children. Reduce speed. Obey crossing guard signals. Look out for children playing. The color of this sign may also be yellow.



Horse-drawn vehicle

Be alert for slow-moving horse-drawn vehicles on the roadway. Reduce your speed and pass slowly.



School bus stop ahead

Watch for children. Be prepared to stop. You are nearing an area where a stopped school bus will pick up or discharge passengers.

7c: Regulation signs

These signs give you information about rules for traffic direction, lane use, turning, speed, parking and other special situations.



Some regulation signs have a red circle with a red slash over a symbol. These indicate you cannot do something; for example, no left turn, no right turn or no U-turn.

Speed limit signs



These signs indicate the maximum or minimum safe speed that is allowed. The maximum limits are for ideal conditions and you must reduce your speed when conditions require it, such as when the roadway is slippery (during rain) or it is difficult to see clearly down the road (during fog). Some high-speed roads have minimum speed limits. If your moped cannot maintain the minimum posted speed, you cannot operate your vehicle on that road. Mopeds may not operate on the interstate.

Lane control signs

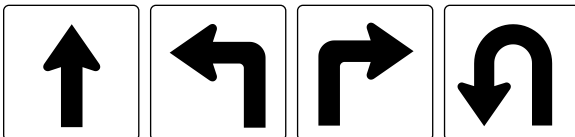

These signs mark where you can go and where you can turn, and often use an arrow symbol. The signs are along the road or hanging over the road. Sometimes arrows may be painted on the road.



Passing signs

These signs mark where it may be safe to pass another vehicle and where you cannot. Passing areas are based on how far you can see ahead. They consider unseen hazards, such as intersections, driveways and other places a vehicle may enter the roadway. The signs indicate where you may pass, the beginning and ending of a passing zone, or where you may not pass. Where passing is allowed, you may do so only if it is safe.

Stop sign

A stop sign is red, with white letters, and has eight sides. It means you must come to a full stop. You must wait until crossing vehicles and pedestrians have cleared. You must stop at the stop line if one is present. If necessary, you may then pull forward to the stop sign or the edge of the intersection and then proceed when it is safe to do so.

Yield sign

A yield sign is shaped like a downward pointing triangle. It is red and white with red letters. It means you must slow down and yield the right of way to traffic in the intersection you are crossing or roadway you are entering.

Keep right

The road ahead is divided. Stay on the right side of the island or barrier.

Wrong way

You made a wrong turn and have entered a lane of oncoming traffic. Get out at the safest and quickest place possible.

One way

Traffic moves only in the direction of the arrow.

Do not enter sign

A square sign with a white horizontal line inside a red circle means you cannot enter. You will see this sign at roadway openings you are not to enter and when traffic is one way against you. You will see them at exit ramps, in crossovers on divided roadways and at numerous locations on one-way roads.

7d: Slow-moving vehicle sign



A reflective orange triangle on the rear of a vehicle means it is traveling 35 mph or less. You may see this sign on road work equipment, farm vehicles, horse-drawn wagons or carriages. It appears as a solid orange triangle by day and hollow red triangle at night.

7e: Guide signs



These signs are square or rectangular shaped, and are green or brown with white lettering. They show directions and distance to various locations or areas, such as cities, airports or state lines; or to special areas, such as national parks, historical areas or museums.

7f: Service signs



These signs are square or rectangular shaped, and are blue with white letters or symbols. They show the location of various services, such as rest areas, gas stations, campgrounds or hospitals.

7g: Route signs



The shape of route signs indicate the type of roadway, such as interstate, U.S. highway, state or county. When planning a trip, use a highway map to determine your route. During the trip, follow the route signs. This will help you stay on your route.

7h: Traffic signals

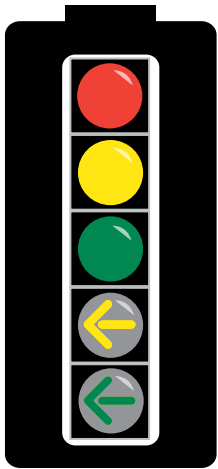

Red

Come to a complete stop at the stop line or before entering the intersection.

Yellow

Do not enter the intersection if you can stop safely. **If you cannot stop safely, proceed through the intersection with caution.** A yellow light warns pedestrians there is not enough time to cross the street. Anyone crossing the street on a yellow light shall yield the

right of way to all vehicles.

Green

Go, but only when the intersection is clear. You must yield to vehicles and pedestrians in the intersection. When the light changes, traffic may be caught in the intersection. You must give them the right of way while they clear the intersection.

Yellow arrow

Do not enter the intersection if you can stop safely. **If you cannot stop safely, proceed only in the direction of the arrow.**

Green arrow

Drive only in the direction of the arrow. Yield the right of way to other vehicles and pedestrians already in the intersection.



Flashing red

Treat it the same as a stop sign.



Flashing yellow

Proceed with caution. Yield to vehicles and pedestrians, and proceed when it is safe.

Left-Turn Signal Head

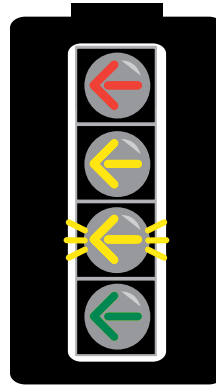

The left-turn signal head has four signals.

1) Steady red arrow

Drivers turning left must stop and wait.

2) Steady yellow arrow

The left-turn signal is about to turn red. Do not enter the intersection if you can stop safely. Complete your left turn if you are already within the intersection.

3) Flashing yellow arrow

Yield to oncoming traffic and pedestrians; then turn left proceeding with caution. Oncoming traffic has a green light.

4) Steady green arrow

Drivers can proceed with the left turn. Oncoming traffic must stop. Do not go straight.

7i: Railroad crossings

- Motorists must use extra caution at railroad crossings. Trains cannot stop quickly.
- Never try to beat a train across the tracks. Even if it is a tie, you will be the loser.
- It is not wise to shift gears when crossing railroad tracks; you might stall.
- Never stop your vehicle on the railroad tracks.

Advance warning signs and pavement markings

indicate railroad tracks cross the road ahead. Be prepared to stop before you get to the tracks if a train is approaching the crossing. Pavement markings are a large "X" with the letters "RR" on the road. These marks are not used at all crossings.

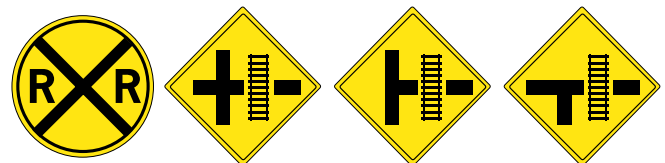

Railroad/highway/side road intersection

Crossbuck signs



These signs have been put at many public railroad crossings. This sign means look both ways, listen for and yield to trains. A number sign under the crossbuck indicates there is more than one set of tracks following the sign.



Flashing light signals

These signals may be used with crossbucks. Stop when the lights are flashing. Do not cross until you can do it safely. If there is more than one track, be careful to watch for trains from either the same or opposite direction.

Flashing
lights

Gates

Gates are used with flashing lights at some crossings. Stop when the lights start to flash before the gate goes down. Remain stopped until the gates go up and the lights stop flashing. **Never drive around the gates.** It is dangerous and against the law. Railroad gates and warning lights are to alert you that a train is in the area. You may collide with a train if you go onto the tracks.

It is against the law to pass any vehicle within 100 feet of a railroad crossing.

Required stops

All school buses, vehicles carrying passengers for hire and vehicles required to be placarded for hazardous materials must stop within 15 to 50 feet of railroad tracks before crossing. If a law enforcement officer or highway traffic signal directs highway traffic to proceed, you do not have to stop. You also do not have to stop if the crossing is marked with an "EXEMPT" sign.

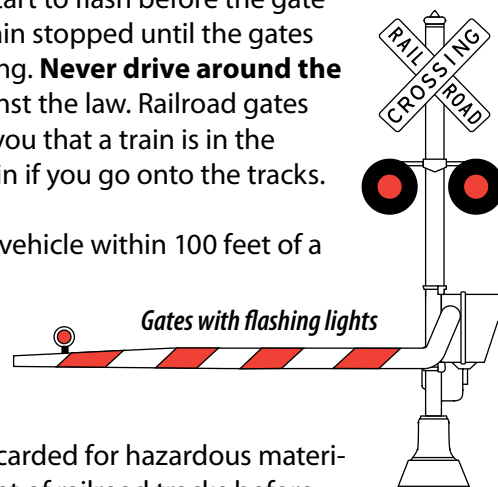

Review questions

1. What other traffic controls must you obey besides traffic signals, traffic signs and pavement markings?
2. What are the standard colors for traffic signs?
3. Where should you stop at a stop sign?
4. How can you tell how many sets of train tracks you will be crossing?
5. How can you tell a warning sign from other posted signs?
6. What does a flashing red light mean?
7. What does a flashing yellow light mean?

8. DISTANCE DETECTION

Now that you have the basics, it is time to discuss more advanced techniques you can use to stay safe.

8a: Distance detection

If you are riding a moped, more than likely you will be riding with other traffic. That is where distance detection comes in. Distance detection is the science of putting time and space between you and potential hazards. A cushion of space is created.

There are three distance detection zones you should remain aware of while operating your moped:

1. **A two-second following distance.**
2. **A four-second immediate path.**
3. **A 12-second anticipated path.**

Two-second following distance

Regardless of what speed you are traveling, you always need a minimum of two seconds between you and the vehicle in front of you. Calculate your two-second following distance by finding a fixed object ahead of you, like a mailbox. Begin counting when the vehicle in front of you passes that object, one-Mississippi, two-Mississippi ... stop counting when you pass the same object. Two seconds is the minimum following distance for ideal weather and road conditions.

Allowing more space increases the time you have to react and execute the appropriate maneuver.

Four-second immediate path

A four-second immediate path means you should be ready to stop for anything four seconds ahead of you.

12-second anticipated path

Your 12-second anticipated path is the distance you need to scan ahead for potential hazards. It may seem like a long time, but it will give you the time and space you need to react.

8b: SEE: Search, evaluate and execute

Once you have developed your distance detection skills, the next step to becoming a safe moped operator is practicing the mental strategy, SEE.

- **Search**
- **Evaluate**
- **Execute**

Search

Use your distance detection to aggressively **search** the roadway. Check areas to the side and rear. Use your mirror frequently and do a head check for those areas that are in your blind spot.

Evaluate

Evaluate what you see. Assess the situation and predict potential hazards. It is important to use good risk management skills so you can figure out what time and space you will require to maintain your safety margin.

Execute

Finally, **execute** the appropriate response. Execution is the action you will take to avoid a potentially dangerous situation. Execution usually involves adjusting your speed or changing your lane position. Whatever you do, be sure to communicate your intentions.

Negotiating a curve is a great opportunity to **search, evaluate and execute**. Search the roadway. Scan the road surface, shoulder area and anticipated path of travel.

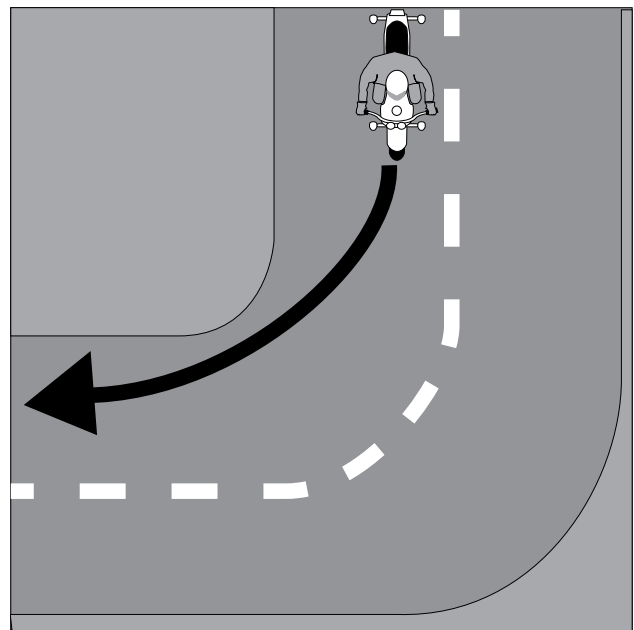

Evaluate possible hazards. Consider the angle of the curve and what could lie ahead of it.

Execute. The rider reacts by using the slow, look, press and roll technique that was discussed earlier. Lane position is also adjusted. The outside/inside/outside path of travel technique helps the operator see farthest around the corner and decreases the severity of the curve's angle.

SEE is a constant process when riding a moped. However, as you continue to practice searching, evaluating and executing it will become automatic.

Visibility is the number one issue facing moped operators. Because mopeds are so much smaller, they are difficult to spot in traffic and their speed is hard for other motorists to judge. The key to being seen is riding smart. In addition to wearing brightly colored clothing, moped operators use lane positioning, braking, signaling, headlights and their horn to make themselves visible to other road users.

Review questions

1. What is meant by cushion of space?
2. What are the three distance detection zones that riders should remain aware of at all times? Explain each of them.
3. Explain how to calculate a two-second distance detection zone.
4. How should you **search**?
5. What are the three steps taken when **executing** your decision?
6. To safely maneuver a curve, what should be considered?

9. VISIBILITY

9a: Lane positioning

Lane positioning is one of the most important things you can do to be seen and extremely important when approaching or entering an intersection. Your position on the roadway is important to your safety. Within the traffic lane, stay where you **CAN SEE AND BE SEEN**. A well thought-out lane choice can increase your margin of safety and provide the maximum cushion of space between you and the other traffic. Never hide among other vehicles.

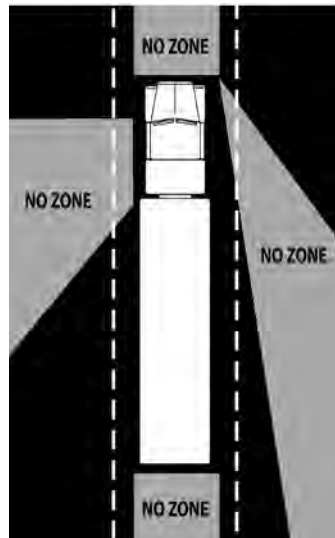

Ride so other motorists with a limited view of the road can see you. Stay out of people's blind spots. The **no-zone** is a term associated with semitrailer, truck traffic. Stay out of their no-zone area. If you cannot see their mirrors, they can not see you either. Lane position should be adjusted constantly to adapt to changes in traffic.

9b: Braking

Being seen in traffic also means alerting other road users to your intentions, especially when slowing or stopping. Rolling back the throttle may slow you, but using your brakes shows the vehicle behind you that you are slowing down. When slowing or coming to a stop, check your mirrors to be sure the driver or rider following you is paying attention. Flashing your brakes when coming to a stop may also be helpful in alerting other motorists.

9c: Signaling

Turn signals draw attention to you and communicate your intentions to other road users. Just remember to cancel them after the maneuver is completed.

9d: Headlight use

In addition to turn signals and brake lights, moped operators use their headlight to increase their visibility among traffic. Riding with your headlight on, even during the day, greatly increases visibility and is required by Iowa law. Your horn can also be used to draw attention to your presence. However, do not rely on it. It is not very loud and can be easily drowned out by loud radios and other distractions.

9e: Night riding

Riding at night is a skill that should be reserved for experienced moped riders. Only after you feel extremely comfortable with the basics should you test your skills by riding at night. It is wise to lower your speed at night. Visibility is decreased and going slower will give you more time and space to react to unexpected situations. Wearing bright colors and reflective gear will greatly increase your visibility.

One of the most important things to remember when riding at night is not to **over drive your headlight**. In other words, your total stopping distance should not exceed the length of your light beam.

Review questions

1. True or false. Proper lane positioning relies on the rider's ability to remain in one constant position. Why or why not?
2. What is the **no-zone**?
3. What is the best way for moped operators to communicate their intentions to surrounding road users?
4. What is over-driving your headlight?

10. HAZARDS

Hazards for moped operators are everywhere. Factors such as wind, rain, oil, potholes, debris, metal, and painted surfaces like railroad tracks and crosswalks can mean serious trouble for moped operators.

10a: Wind

Because your moped is lighter and more responsive, strong winds pose a serious safety concern. Lean into the wind to increase stability. Be aware that if you pass by trees or a building and the wind is cut off, your moped could go into the other lane. Keep your moped on the side of the lane the wind is coming from just in case a big blast moves you across the lane. If you are having difficulty controlling your moped, please pull over. Wait for the wind to die down or call for a ride.

10b: Wet surfaces

Wind is not the only element that poses a threat to moped riders. There is also rain. The most dangerous time to ride your moped is right after it begins to rain. Oil residue on the roadway mixes with water and rises to the road's surface, making riding conditions extremely slippery and causing vehicles to hydroplane. Visit a friend or grab a soda while you wait for the oil to wash away. When you get back on the road, slow down to allow yourself more time and space to react to hazards. It is more difficult to see and to be seen in the rain, and your moped will take longer to stop on wet surfaces.

10c: Slippery surfaces

To pass safely over slippery surfaces, remember to SEE – search, evaluate and execute. Search your 12-second anticipated path for slippery road surfaces. Assess the situation to determine your response and execute your maneuver. Always brake before you reach the slippery surface. Braking on a slippery surface is likely to cause a crash. Coast over the slippery surface in a straight line, keeping your body upright and wheels straight.

10d: Crossing hazards safely

Avoid hazards whenever possible. However, many times potholes, bumps and road debris are unavoidable. Slow down as much as you can and approach the object at a 90-degree angle, if possible. Slightly rise off the seat and shift your weight to the rear, keeping your knees bent. Speed up slightly as you connect with the object, then release the throttle and coast over it. Sit back down and continue your journey.

10e: Animals

Hazards for moped riders come in many different shapes and forms. Some even have four legs. Animals on the road pose problems for all vehicles, but are especially dangerous for moped operators. To safely avoid a dog in your path of travel, slow down until you are close to it, then honk your horn and accelerate past. Remember to always watch for deer crossing the roadway, especially during late fall when deer are on the move in search of food and a mate. If you see one deer, chances are more are soon to follow.

10f: Crossing railroad tracks

Railroad crossings require extra caution. Trains cannot stop quickly and create an optical illusion, which makes a train appear farther away than it actually is. Never try to beat a train across the tracks. Never stop your moped on the railroad tracks. Obey all signs and signals posted on or near railroad tracks. It is also important to remember that rail grade crossings can be very slippery. Remember to use the SEE principle discussed earlier in this unit.

10g: Hand-held phone use

It is highly dangerous to divide your attention from the task of driving by using hand-held phones, text messaging devices and electronic entertainment devices.

It is unlawful for any driver in Iowa to read, write or send a text message while driving. Before using a hand-held electronic communication device to write, send or read a text message, the vehicle must be brought to a complete stop off the traveled portion of the roadway. Exceptions to reading a text message are limited to:

- A member of a public safety agency performing official duties.
- A health care professional in the course of an emergency situation.
- A person receiving safety-related information, including emergency, traffic or weather alerts.

It is unlawful for persons under the age of 18 operating a motor vehicle with a minor restricted license, instruction permit, intermediate license or minor school license to use an electronic communication device (including hand-held phones) or an electronic

entertainment device unless the vehicle is at a complete stop off the traveled portion of the roadway.

Expect the unexpected when riding a moped. Hazards are everywhere and can have serious consequences if not dealt with properly. Use the skills you have learned in this course to minimize the risk of the hazards you may encounter.

Review questions

1. If you are traveling north and the wind is blowing from the east, what side of the lane should you be traveling on?
2. When is it most dangerous during a rain? Why?
3. Explain how to safely pass over a slippery surface.
4. When should you be most alert for deer crossing the roadway?
5. Why is it dangerous to use your mobile phone while operating your moped?

II. IMPAIRED DRIVING

Operating your moped under the influence of alcohol, drugs or other narcotics is strictly prohibited and doing so will cost you your driving privileges, thousands of dollars in fines, and high insurance rates; or possibly your life or that of others.

Riding a moped takes skill and a high degree of mental alertness. Drugs and alcohol impair your perception, reflexes and willingness to cooperate with other road users.

Iowa has an Implied Consent law, which means a law enforcement officer can ask you to submit to a breath, urine or blood test to determine your blood alcohol concentration or "BAC." The current BAC level is 0.08 for anyone age 21 or older. If you are 21 or older and plan to drink, keep in mind that it takes a long time for the effects of alcohol to be cleared from your body – roughly one hour for each bottle of beer, glass of wine or shot of liquor. If you are under 21 years old, Iowa has a zero tolerance policy, meaning any trace of alcohol will result in fines, the loss of your driver's license and other negative consequences.

If you know someone is about to drive impaired, take the keys and help your friend find a safe ride home. Groups are often most effective at dissuading someone from driving impaired.

Many of you would never make the decision to drink or use drugs. However, it is important to understand when you become a licensed driver, no matter what type of vehicle, the decisions you make every second, no matter how big or small, will affect the rest of your life and the lives of others.

Review questions

1. Name some of the consequences of operating your moped while under the influence of drugs or alcohol.
2. What are three mental or physical states that are affected by alcohol use?
3. What does the Iowa Implied Consent law mean?
4. True or false. When attempting to stop someone from driving impaired you should approach them by yourself and privately address the issue.
5. How long does it take for the affects of alcohol to be cleared from the body?
6. What blood alcohol concentration (BAC) is allowed by law for anyone under the age of 21?

12. ENJOY THE RIDE

Riding a moped is a constant learning experience. Be a life-long learner; wear proper protective gear and ride within your personal limits.

It only takes one mistake or lapse in judgement to affect the rest of your life. Operating a motor vehicle is a serious responsibility and should be treated as such.

Be smart, and use what you have learned in this manual to stay safe. Just do not forget to enjoy the ride.

GLOSSARY OF TERMS

Alcohol – a depressant drug consumed as a beverage

Attitude – a feeling or emotion regarding a fact

BAC (blood alcohol concentration) – percentage by volume of alcohol in the bloodstream

Centrifugal – the force that tends to impel a thing or parts of a thing outward from a center of rotation

Conspicuous – easily seen by others; highly visible

Counter-steer – a momentary steering deflection away from the intended direction of travel accomplished by pressing on the handgrip in the direction of the turn; used to produce a lean in the desired direction (press right, lean right, go right; press left, lean left, go left)

Crash – to fall, land or hit with destructive force; an unexpected and undesirable event

Distance detection zones – basis of a strategy to use the eyes and mind to reduce/manage risk: two-second following distance; four-second immediate path; 12-second anticipated path

DOT – Department of Transportation – federal law requires that all helmets sold in the United States meet U.S. DOT performance standards; check the label on the helmet before you buy

Head check – before committing to any action when driving you have to move your head to check that the way is clear

Hydroplaning – loss of traction caused by a build-up of water, oil and dirt under the tires, especially when rain first begins to fall

Hypothermia – subnormal body temperature due to the cooling effects of cold and wind on exposed skin

Legal limit – blood alcohol content (BAC) level designated by a state as the level at which a person is legally intoxicated

No-zone – the area around a truck or other vehicle that cannot be seen in the vehicle's mirror

Peripheral vision – area to the sides of your line of sight that can be seen while looking straight ahead

Retroreflective – ability of a surface to reflect light; a term for clothing and signs referred to in the manual

Responsible – able to answer for one's conduct and obligation

SEE – an acronym for a dynamic strategy for seeing and being seen: Search, Evaluate, Execute

Space cushion – a margin of safety created by adding space between your vehicle and the one ahead or to the sides

Tailgating – following at a distance of less than two seconds

T-CLOCS – an acronym for the moped pre-ride inspection checklist: tires and wheels; controls; lights and electronics; oil and other fluids; chassis; stand (side or center)

Visibility – ability to see and/or be seen

FINAL EXAM QUESTIONS

Please circle the correct answer.

1. T-CLOCS is a way to remember:

- a) The three lead times.
- b) Preride inspection.
- c) Start-up procedure.

Final score _____

2. The greatest chance for conflict with other traffic is:

- a) At intersections.
- b) Passing another vehicle.
- c) Leaving your driveway.

3. A rain-slick surface:

- a) Allows for better traction.
- b) More fun than a dry surface.
- c) Is most slippery during the first 1/2 hour of rain because of road residue.

4. Carrying a passenger:

- a) Affects moped handling.
- b) Can make your moped more stable.
- c) Is against the law.

5. The best way to achieve maximum braking is to:

- a) Apply both brakes without locking either wheel.
- b) Use only the front brake because that supplies the most stopping power.
- c) Lock the rear wheel and apply some front brake.

6. What type of injury is most commonly associated with fatalities in a crash?

- a) Leg
- b) Head
- c) Arm

7. SEE stands for:

- a) Search, Estimate, Escape.
- b) See , Evaluate, Escape.
- c) Search, Evaluate, Execute.

8. What official sticker is found on an approved helmet?

- a) DOT
- b) MOP
- c) BRC

9. Hypothermia occurs when:

- a) You do not wear protective gear.
- b) Body temperature is below normal.
- c) Winds reach 25 mph.

10. The minimum recommended following distance is:

- a) Four seconds.
- b) 12 seconds.
- c) Two seconds.

11. If a dog runs toward you while riding, you should:

- a) Honk your horn.
- b) Kick at the dog.
- c) Stop suddenly.

12. What is the no-zone?

- a) Somewhere you cannot ride your moped.
- b) A large truck's blind spot.
- c) The middle of a lane.

13. If someone has three alcoholic drinks, approximately how long will it take to leave the body?

- a) Two hours
- b) Six hours
- c) Three hours

14. A full-coverage helmet is preferred over other styles because:

- a) Provides more protection.
- b) You can see better.
- c) You are more visible in traffic.

15. Most crashes are caused by:

- a) The other driver.
- b) Riding at night.
- c) Multiple factors.

16. You must carry this with you when you ride your moped:

- a) Proof of insurance.
- b) Proof of completion of this course.
- c) A passenger.

17. You should wear high-visibility clothing:

- a) Only at night.
- b) So you can be seen by other drivers more easily.
- c) Because it makes you look cool.

18. Good riding posture includes:

- a) Arms and elbows are straight.
- b) Wrist is in the up position.
- c) Head and eyes are up.

19. A flashing red light is the same as:

- a) A yield sign.
- b) A do not enter sign.
- c) A stop sign.

20. At a railroad crossing you should:

- a) Check for approaching trains.
- b) Continue because the lights are not flashing.
- c) Stop everytime.

21. When you know someone has been drinking:

- a) Approach him/her in a group, take the keys and find him/her a safe way home.
- b) Argue with them.
- c) Make them stay over night.

22. Hydroplaning occurs when:

- a) You follow another vehicle too closely.
- b) Water washes off the pavement.
- c) Water builds up under the tires.

23. Swerving consists of:

- a) Two consecutive turns.
- b) Braking to miss a hazard.
- c) Two slow turns.

24. When changing lanes on a moped:

- a) There is no need to do a head check.
- b) Check your mirrors, glance over your shoulder to check your blindspot and signal your intentions.
- c) Signals are not required if no one is there.

IOWA CODE 321.189(7) DRIVER'S LICENSE CONTENT

7. Motorized bicycle.

a. The department may issue a driver's license valid only for operation of a motorized bicycle to a person fourteen years of age or older who has passed a vision test or who files a vision report as provided in section 321.186A which shows that the applicant's visual acuity level meets or exceeds those required by the department and who passes a written examination on the rules of the road. A person under the age of sixteen applying for a driver's license valid only for operation of a motorized bicycle shall also be required to successfully complete a motorized bicycle education course approved and established by the department or successfully complete an approved motorized bicycle education course at a private or commercial driver education school licensed by the department. A public school district shall charge a student a fee which shall not exceed the actual cost of instruction. A driver's license valid only for operation of a motorized bicycle entitles the licensee to operate a motorized bicycle upon the highway while having the license in the licensee's immediate possession. The license is valid for a period not to exceed two years from the licensee's birthday anniversary in the year of issuance, subject to termination or cancellation as provided in this section.

b. A driver's license valid only for operation of a motorized bicycle shall be canceled upon a conviction for a moving traffic violation and reapplication may be made thirty days after the date of cancellation. The cancellation of the license upon conviction for a moving traffic violation shall not result in requiring the applicant to maintain proof of financial responsibility under section 321A.17, unless the conviction would otherwise result in a suspension or revocation of a person's driver's license.

c. As used in this section, "moving traffic violation" does not include a parking violation as defined in section 321.210 or a violation of a section of the Code or municipal ordinance pertaining to standards to be maintained for motor vehicle equipment except sections 321.430 and 321.431, or except a municipal ordinance pertaining to motor vehicle brake requirements as applicable to motorized bicycles.

d. The holder of any class of driver's license may operate a motorized bicycle.

e. A person who violates this subsection commits a simple misdemeanor.

IAC 7/2/08

Transportation[761]

Ch 636, p.1

CHAPTER 636

MOTORIZED BICYCLE RIDER EDUCATION

761—636.1(321) Information and location. Applications, forms and information regarding this chapter are available by mail from the Office of Driver Services, Iowa Department of Transportation, P.O. Box 9204, Des Moines, Iowa 50306-9204; in person at 6310 SE Convenience Blvd., Ankeny, Iowa; by telephone at (515) 237-3153; or by facsimile at (515) 237-3071.

761—636.2(321) Definitions.

"Approved course" means the motorized bicycle rider education course approved by the department.

"Sponsor" means an entity that delivers the approved course.

761—636.3 Reserved.

761—636.4(321) Agencies or institutions. Any school district, area education agency, merged area school, other agency or individual planning to offer a motorized bicycle rider education course must receive course approval from the department prior to the beginning of the first class that is offered

and annually thereafter. The agency or institution or individual shall complete a form provided by the department to apply for course approval. Course approval will be issued for a calendar year or remainder of a calendar year. The approval expires on December 31 and must be renewed annually.

761—636.5(321) Private or commercial sponsors. The department licenses private and commercial sponsors offering motorized bicycle rider education.

636.5(1) Instructor and course approval. The department must approve the sponsor's course and instructors prior to the beginning of the first class that is offered and annually thereafter.

636.5(2) Application and fees. Application for authorization or renewal shall be made to the department on forms provided by the department. The fee for an authorization or a renewal is \$25 for a private or a commercial sponsor. The fee must be paid by cash, money order or check. A money order or check must be for the exact amount and should be made payable to the Treasurer, State of Iowa, or the Department of Transportation.

636.5(3) Issuance and renewal. Authorization to offer motorized bicycle rider education shall be issued for a calendar year or remainder of a calendar year. The authorization expires on December 31 and must be renewed annually.

636.5(4) Cancellation. The authorization to teach motorized bicycle rider education shall be canceled if the course or instructors are no longer approved.

761—636.6 Reserved.

761—636.7(321) Course requirements.

636.7(1) Classroom instruction. An approved course shall consist of a minimum of six clock hours of classroom instruction which includes the instructional components contained in subrule 636.7(3).

636.7(2) Driving instruction. Motorized bicycle rider driving experiences in addition to classroom instruction are permissible, but not required.

636.7(3) Course content. The following instructional components shall be incorporated in every motorized bicycle rider education course.

a. Operator and motorized bicycle preparation.

- (1) Knowledge of Iowa driving laws.
- (2) Knowledge of vehicle registration requirements.
- (3) Vehicle inspection.
- (4) Protective clothing and devices.
- (5) Risk assessment.
- (6) Route selection.

b. Basic control skills.

- (1) Starting procedures.
- (2) Speed control.
- (3) Turning.
- (4) Stopping.

c. Safe driving practices.

- (1) Use of lights and warning devices.
- (2) Signaling.
- (3) Maintaining directional control.
- (4) Perception skills and observation.
- (5) Use of mirrors.
- (6) Recognition of hazards.
- (7) Speed control.
- (8) Lane positioning.
- (9) Concerns and conflicts regarding intersections.

(10) Following distances.

(11) Lateral separation.

d. *Complex situations.*

(1) Limited visibility.

(2) Adverse weather.

(3) Critical situations.

(4) Malfunctions.

e. *Motorized bicycle care.*

(1) Inspection.

(2) Maintenance.

761—636.8(321) Teacher qualifications. A teacher of an approved motorized bicycle rider education course shall possess a valid license allowing unaccompanied driving other than a temporary restricted license and shall be able to operate a motorized bicycle. A teacher must also have a clear driving record for the previous two years. A clear driving record means the teacher has:

636.8(1) Not been identified as a candidate for driver's license suspension under the habitual violator provisions of rule 761—615.13(321) or the serious violation provisions of rule 761—615.17(321).

636.8(2) No driver's license suspensions, revocations, denials, cancellations, disqualifications or bars.

636.8(3) Not committed an offense that would result in driver's license suspension, revocation, denial, cancellation, disqualification or bar.

636.8(4) No record of an accident for which the individual was convicted of a moving traffic violation.

761—636.9(321) Evaluation. Each student shall be evaluated to determine successful completion of the course.

These rules are intended to implement Iowa Code section 321.189.

[Filed 3/10/04, Notice 2/4/04—published 3/31/04, effective 5/5/04]

[Filed 12/12/07, Notice 11/7/07—published 1/2/08, effective 2/6/08]



Iowa Department of Transportation
800 Lincoln Way
Ames, Iowa 50010
515-239-1101
www.iowadot.gov

Federal and state laws prohibit employment and/or public accommodation discrimination on the basis of age, color, creed, disability, gender identity, national origin, pregnancy, race, religion, sex, sexual orientation or veteran's status. If you believe you have been discriminated against, please contact the Iowa Civil Rights Commission at 800-457-4416 or Iowa Department of Transportation's affirmative action officer. If you need accommodations because of a disability to access the Iowa Department of Transportation's services, contact the agency's affirmative action officer at 800-262-0003.

Do more online and skip a trip.

Many of the services you receive at driver's license issuance sites are now available to you online, anytime.



Specialty and personalized plates. new

Check availability of a personalized number/letter combination and order your plates.

Online renewal

Renew your driver's license or ID online.

Electronic renewal notification

Sign up to receive an email reminder when it's time to renew your driver's license/ID.

Mailing address change

Review or change your mailing address on file with the Iowa DOT.

Driving record

Obtain a free, noncertified copy or purchase a certified copy of your driving record.



To access myMVD,

scan the QR code with a QR reader on your smartphone or other mobile device, or visit <https://mymvd.iowadot.gov>.

Know when to stop or pass a school bus?

Not knowing could cost you your driver's license and a whole lot more.

For more information about school bus safety,

including penalties for violation, visit:

iowadot.gov/schoolbus.

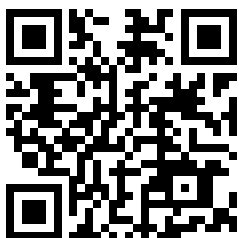

Traveling on a two- or three-lane road

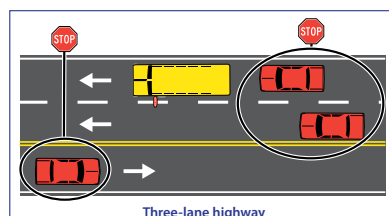
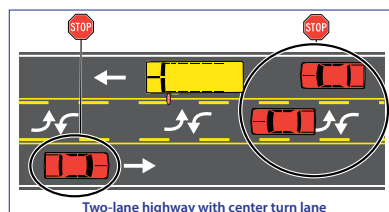
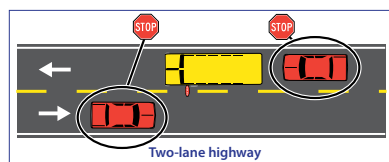

Traveling on a road with two or more lanes in each direction

