

November 2008

RESEARCH PROJECT TITLE

Use of Ultra-High Performance Concrete in Geotechnical and Substructure Applications

SPONSOR

Iowa Highway Research Board (TR-558)

PRINCIPAL INVESTIGATOR

Muhannad T. Suleiman
Assist. Prof., Civil and Environmental
Engineering
Lafayette College
610-330-5413
suleimam@lafayette.edu

CO-PRINCIPAL INVESTIGATOR

Sri Sritharan
Assoc. Prof., Civil, Construction &
Environmental Engineering
Iowa State University
515-294-5238
sri@iastate.edu

MORE INFORMATION

www.ctre.iastate.edu

CTRE

Iowa State University
2711 S. Loop Drive, Suite 4700
Ames, IA 50010-8664
515-294-8103

The mission of the Center for Transportation Research and Education (CTRE) at Iowa State University is to develop and implement innovative methods, materials, and technologies for improving transportation efficiency, safety, and reliability while improving the learning environment of students, faculty, and staff in transportation-related fields.

The sponsors of this research are not responsible for the accuracy of the information presented herein. The conclusions expressed in this publication are not necessarily those of the sponsors.

Ultra-High Performance Concrete in Geotechnical and Substructure Applications

tech transfer summary

Ultra-high performance concrete pile foundations can help bridges extend service life, avoid drivability problems, and ensure durability.

Research Objectives

- Develop the design concept and demonstrate the potential use of ultra-high performance concrete (UHPC) in geotechnical applications
- Evaluate the behavior of UHPC piles using large-scale tests and analytical procedures

Problem Statement

In 2005, the American Association of State Highway Transportation Officials (AASHTO) issued seven “grand challenges” for a strategic bridge engineering plan. At the top of the list were extending service life and optimizing structural systems. One of the greatest challenges to achieving the targeted 75-year design life for a typical bridge is material deterioration of the foundations. Traditional piles (steel and concrete) are subjected to corrosion and deterioration. Additionally, concrete piles are subjected to cracking and crushing due to excessive tensile and compressive stresses, and steel piles can experience local buckling during driving.

Using precast, prestressed pile foundations made of UHPC may help achieve the targeted service life, avoid drivability problems, and ensure durability in future bridges.

UHPC Pile Description

For this research, a 10 by 10 in. UHPC pile with a tapered H-shaped cross section was selected (Figure 1). This pile shape offers efficient use of the UHPC material, is easy to form, and allows air to escape as UHPC is poured into the section from top to bottom.

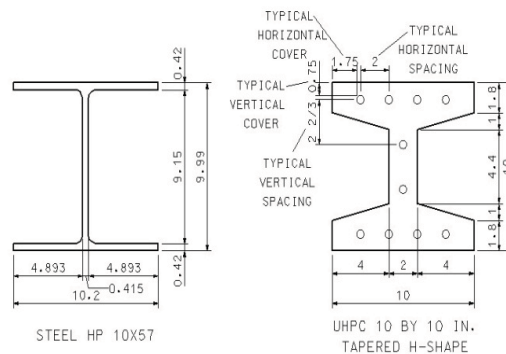

Figure 1. Steel HP 10x57 pile (left) and 10 by 10 in. tapered H-shaped section (right). The HP 10x57 section is commonly used by many states.

Field Investigation

Location and Soil Properties

Two 35 ft long UHPC piles (P1 and P2) and one 35 ft long steel HP 10x57 pile were installed next to a bridge being constructed in fall 2007 near Oskaloosa, Iowa. The soils were characterized using the standard penetration test (SPT), two cone penetration tests (CPT), and Iowa borehole shear tests.

Pile Driving

The piles were driven using a DELMAG D19-42 hammer with a 2 in. thick hammer cushion made of aluminum and micarta (Figure 2). During driving, pile driving analyzer (PDA) strain gages and accelerometers were used to measure the force and velocity near the pile heads. From the strain and acceleration measurements, the PDA computed force and velocity curves vs. time for each blow of the hammer (Figure 3). The shape of these curves indicates soil resistance and pile integrity.

Each of the UHPC piles and the steel pile were driven to a penetration depth of 32.5 ft. Due to a hard soil layer at a penetration depth of approximately 26 to 28 ft, the plywood cushions for the UHPC piles disintegrated, and both piles were effectively driven without a pile cushion over the last several feet. However, neither UHPC pile suffered damage during driving.

A total of 275 blows were required to drive the UHPC pile P1, and a total of 175 blows were required to drive the HP 10x57 pile (Figure 4). The number of blows per foot increases in the hard layer at a depth of approximately 26 ft and, to a lesser extent, at a moderately hard layer from 16 to 19 ft.

Vertical Load Test

Vertical load tests were conducted in the field on UHPC pile P1 and the steel HP 10x57 pile (Figure 5, top). The load test on the UHPC pile had to be stopped at a load of 300 kips, which was the capacity of the load cell, and the load test results for the UHPC pile were extrapolated.

Lateral Load Test

The lateral load test followed the standard loading procedure outlined in ASTM D 3966 – 07 (Figure 5, bottom). The research team tested both piles, but focused on UHPC pile P2, which had not been tested under vertical loads.

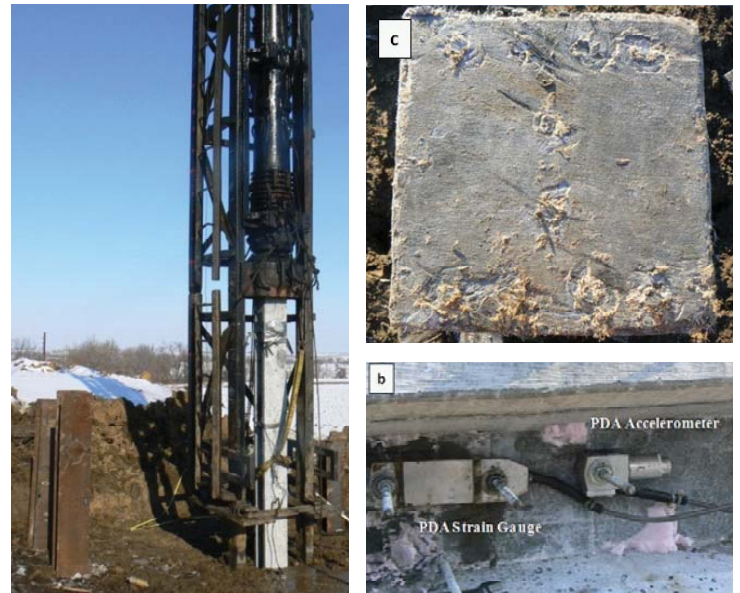

Figure 2. Pile driving hammer (left), UHPC pile head after driving (top right), strain gages and accelerometers (bottom right).

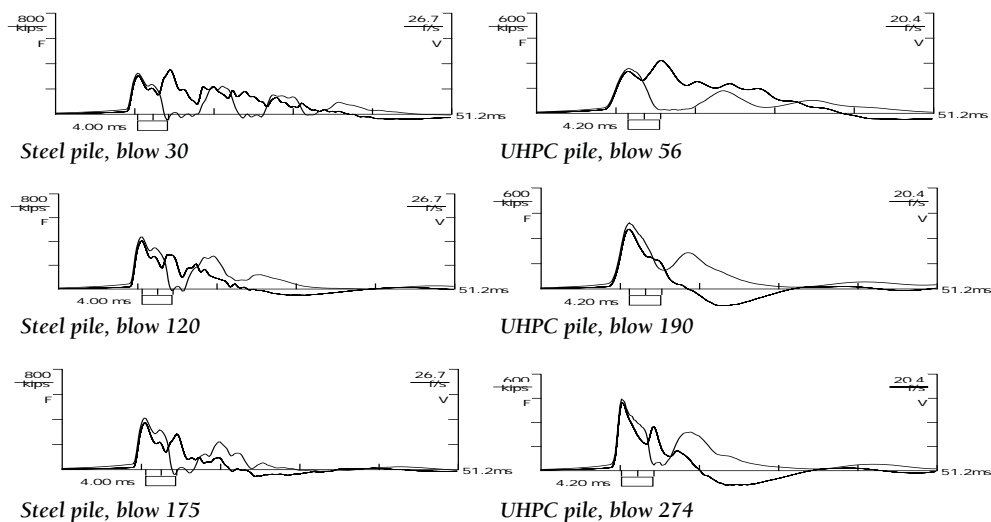

Figure 3. Force and velocity PDA diagrams for both piles during easy driving at 15 ft (top row), hard driving at 27.5 ft (middle row), and final depth at 32.5 ft (bottom row).

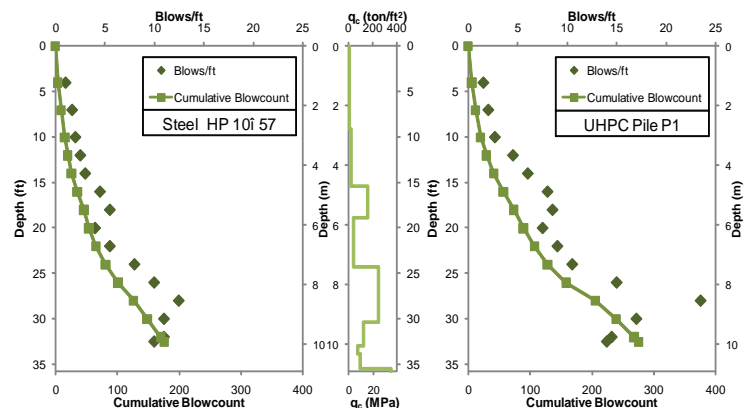

Figure 4. Driving log of blows/ft and cumulative blow count.

Laboratory Verification

Laboratory tests were used to verify the moment-curvature behavior of two three-quarters-scale UHPC test units.

Key Findings

- An optimized prestressed UHPC pile section was successfully designed with no mild steel reinforcement. The weight of the 10 by 10 in. tapered H-shaped UHPC pile section is approximately equal to that of a regularly used HP 10×57 steel pile, but the UHPC pile has a higher vertical load capacity.
- The designed UHPC piles can be successfully cast in precasting plants. Compressive strengths in the range of 26 to 29 ksi are achievable with the recommended heat treatment procedure.
- UHPC piles can be driven with same equipment used for driving steel piles of equal size and weight.
- Results from PDA measurements during the driving of the UHPC and steel piles show no signs of damage to the UHPC piles during driving and indicate that drivability analysis can be used to calculate the compressive driving stresses accurately. CPT test results accurately estimated soil resistance during pile driving.
- The GRL Engineers, Inc. Wave Equation Analysis of Pile driving (GRL WEAP) shows that the pile driving stresses for the UHPC piles are typically well below the piles' allowable stress limits. The pile cushion for UHPC piles may be eliminated or reduced well below the thickness used for normal concrete piles. In this study, the UHPC piles were successfully driven without a pile cushion for approximately 2 to 4 ft through sand/silty sand and sandy silt/clayey silt soil layers, with no damage observed at the end of driving.
- Force and velocity diagrams for the steel HP 10×57 pile and UHPC pile P1 during the three driving phases show that, for both piles, the force wave dissipates more quickly after the first cycle in the driving through the hard layer and at the end of driving than in the easy driving (see Figure 3).
- The axial load capacity of the UHPC pile was 85% greater than that of a comparable steel pile, mainly due to the UHPC pile's larger cross-sectional area. This suggests that a smaller total number of UHPC piles may be required for a bridge foundation. Moreover, the maintenance costs of the UHPC pile foundations are expected to be lower than those associated with traditional pile types.
- The estimated vertical load capacity of the UHPC pile was 368 kips, and the capacity of the steel pile was 198 kips (Figure 6).



Figure 5. Vertical load test on UHPC pile P1 (top) and lateral load test on UHPC pile P2 (bottom).

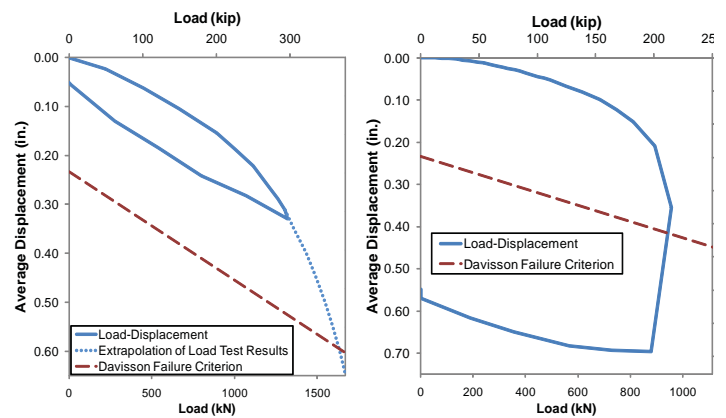

Figure 6. Vertical load-displacement behavior for UHPC pile P1 (left) and the steel pile (right). The Davisson criterion (dashed line) was used to determine the capacity of each pile.

Key Findings (continued)

- The lateral load-displacement for UHPC pile P2 at the point of load application was 2.54 in. at an applied lateral load of 22.8 kips. The calculated load-displacement relationship, obtained using LPILE software with the CPT-estimated soil properties and the nonlinear moment-curvature relationship for the UHPC cross section, indicates a very good agreement with the measured response (Figure 7).
- The moment-curvature data from the first laboratory test (Figure 8), performed with a constant 80 kip axial load, match closely with the calculated moment-curvature response for the pile section at this axial load. Before the second test was stopped, the test unit developed its first flexural cracks at a lateral load of 5.2 kips while under no axial load. The predicted lateral cracking load was 4.9 kips under a 0 kip axial load (Figure 9).

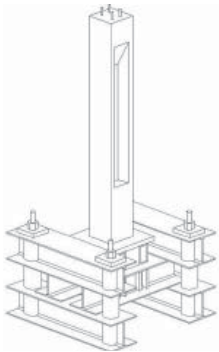

Figure 8. Setup of laboratory testing.

Implementation Benefits

- The UHPC material features a smaller weight and easier handling than the concrete used in normal prestressed piles.
- H-shaped UHPC piles are the same weight as currently used steel piles and thus require no special equipment.
- UHPC piles have a smaller chance of damage during driving than concrete piles and, in some cases, steel piles.
- H-shaped UHPC piles are drivable using a greater range of hammers and strokes than those used for normal concrete or high-performance concrete piles.
- UHPC piles require less labor during field driving than concrete piles because no pile cushion is needed and smaller cross sections can be used.
- UHPC piles have higher load capacities, necessitating fewer piles than the number required if steel piles are used.
- Due to UHPC's high durability, lower maintenance costs are expected than for steel and concrete piles, providing UHPC piles a lower life-cycle cost.

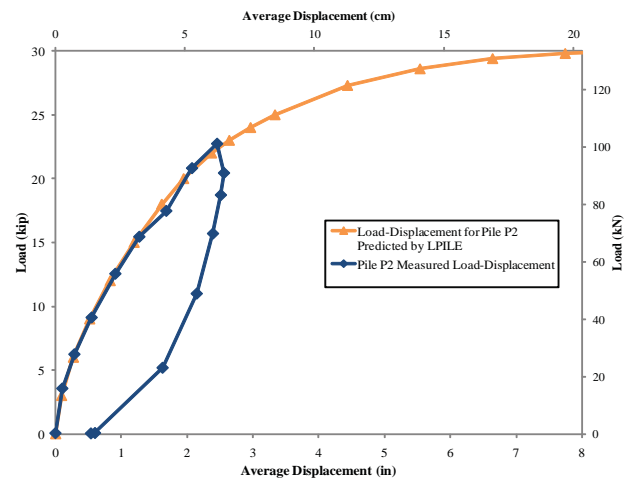

Figure 7. Measured lateral load-displacement behavior of UHPC pile P2 compared with calculated response using LPILE.

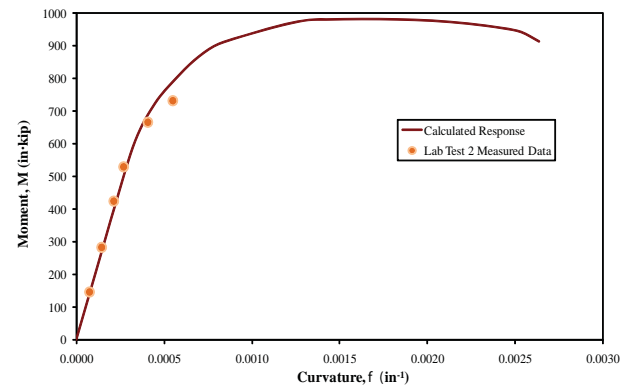

Figure 9. Calculated and measured moment-curvature response of a $\frac{3}{4}$ -scale UHPC laboratory test unit.

Recommendations for Further Research

Before UHPC piles can be fully implemented, several critical issues require further investigation:

- The connection between the pile and pile cap and between the pile and bridge abutment
- The evaluation and development of the geotechnical pile type and design methods
- The driving and behavior of UHPC battered piles
- The behavior of UHPC pile groups
- The performance of UHPC piles under real construction and loading conditions