

Flying Activity Book

Office of Aviation

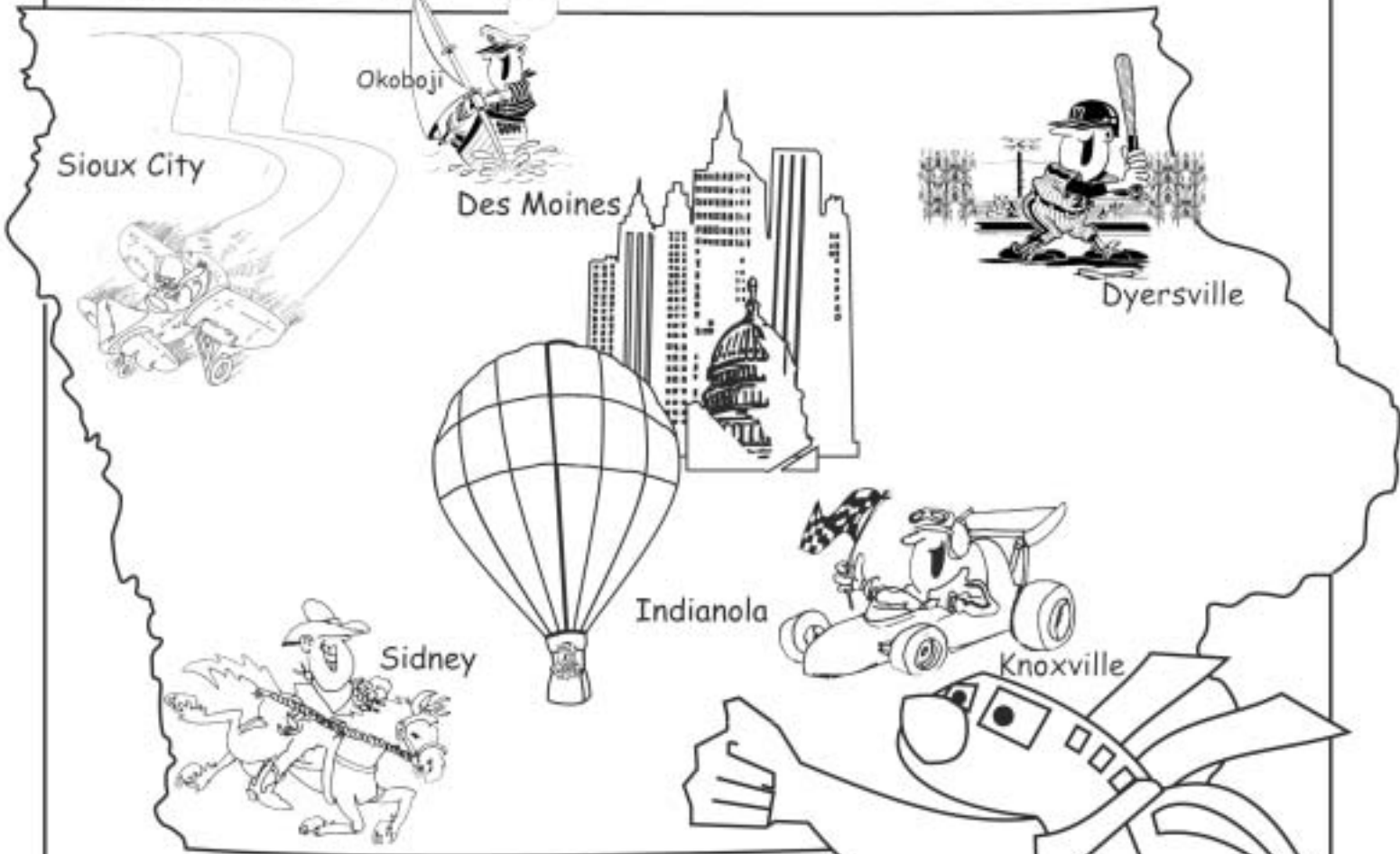

"Color my pages
and learn about
flying in Iowa."



"Contact me
if you want to
know more about
flying in Iowa."



Flying
Activity Book

Office of Aviation

Office of Aviation
Iowa Department of Transportation
800 Lincoln Way
Ames, Iowa 50010
515-239-1875

WWW.IAWINGS.COM

Parts of an

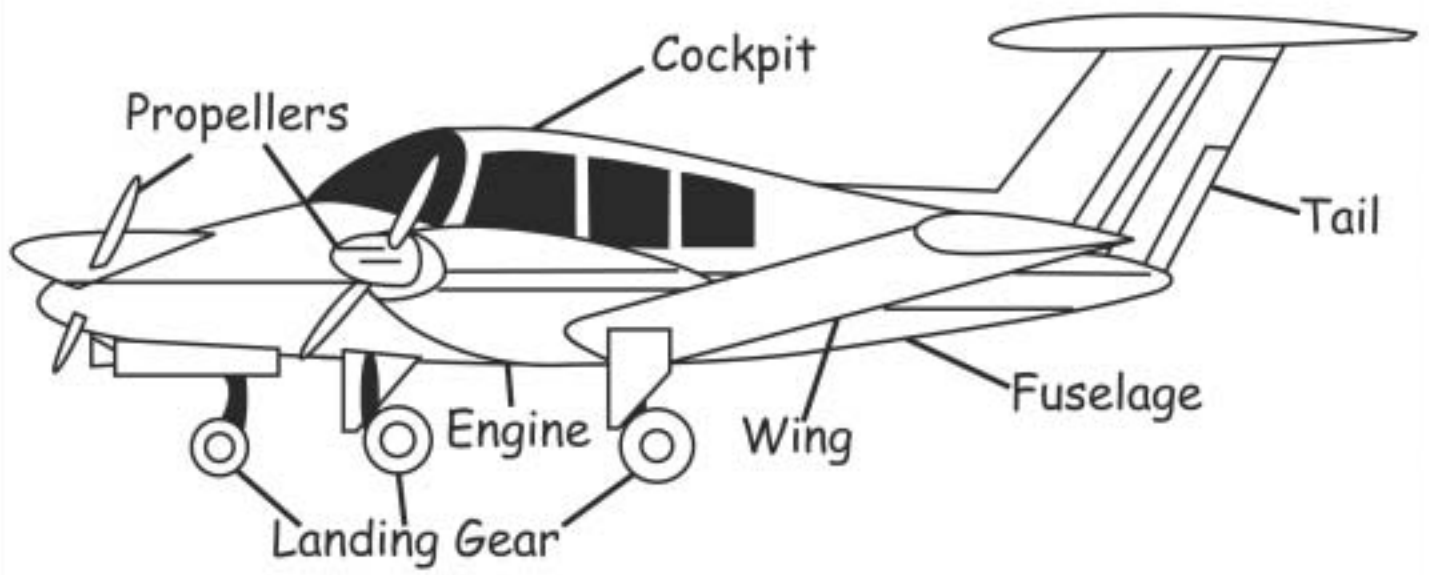

airplane



The first
aircraft were
hot air balloons.

A line drawing of a globe with a speech bubble containing text. The globe shows the outlines of continents. The speech bubble is positioned in the upper half of the globe. Below the globe, there is a line drawing of a jet airplane in flight, moving from left to right. The entire scene is enclosed in a rounded rectangular border.

Airplanes carry
people to ...

all parts of
the world.



Airplanes are used
to spray crops to control
insects and diseases.

Many Iowa products are shipped by air.

IOWA AIRLINES

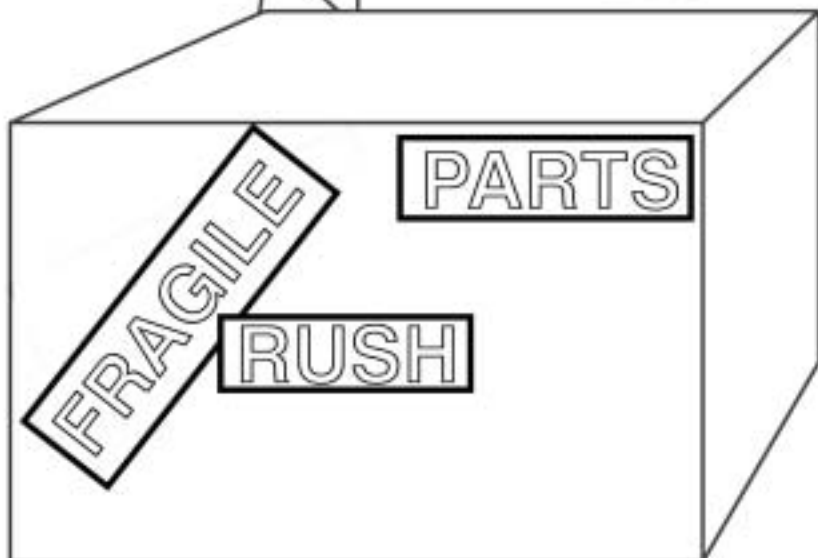
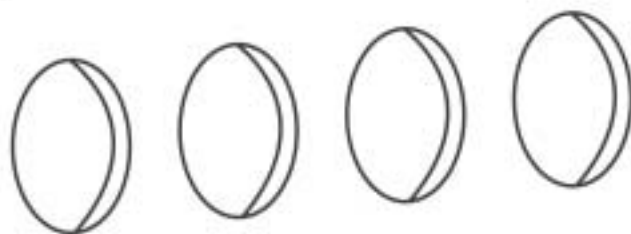

Emergency aircraft fly patients to hospitals.

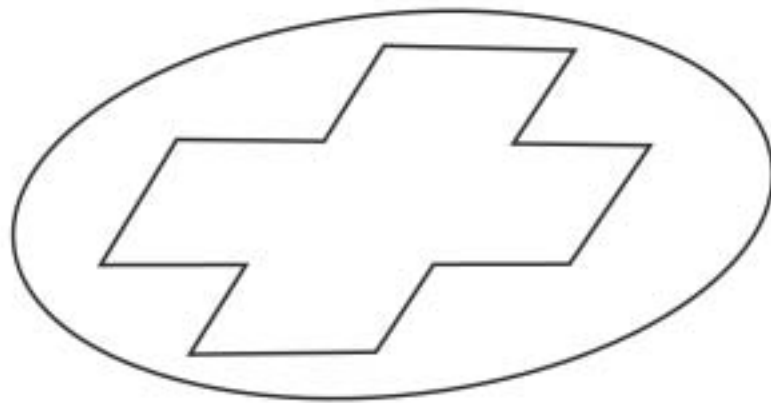
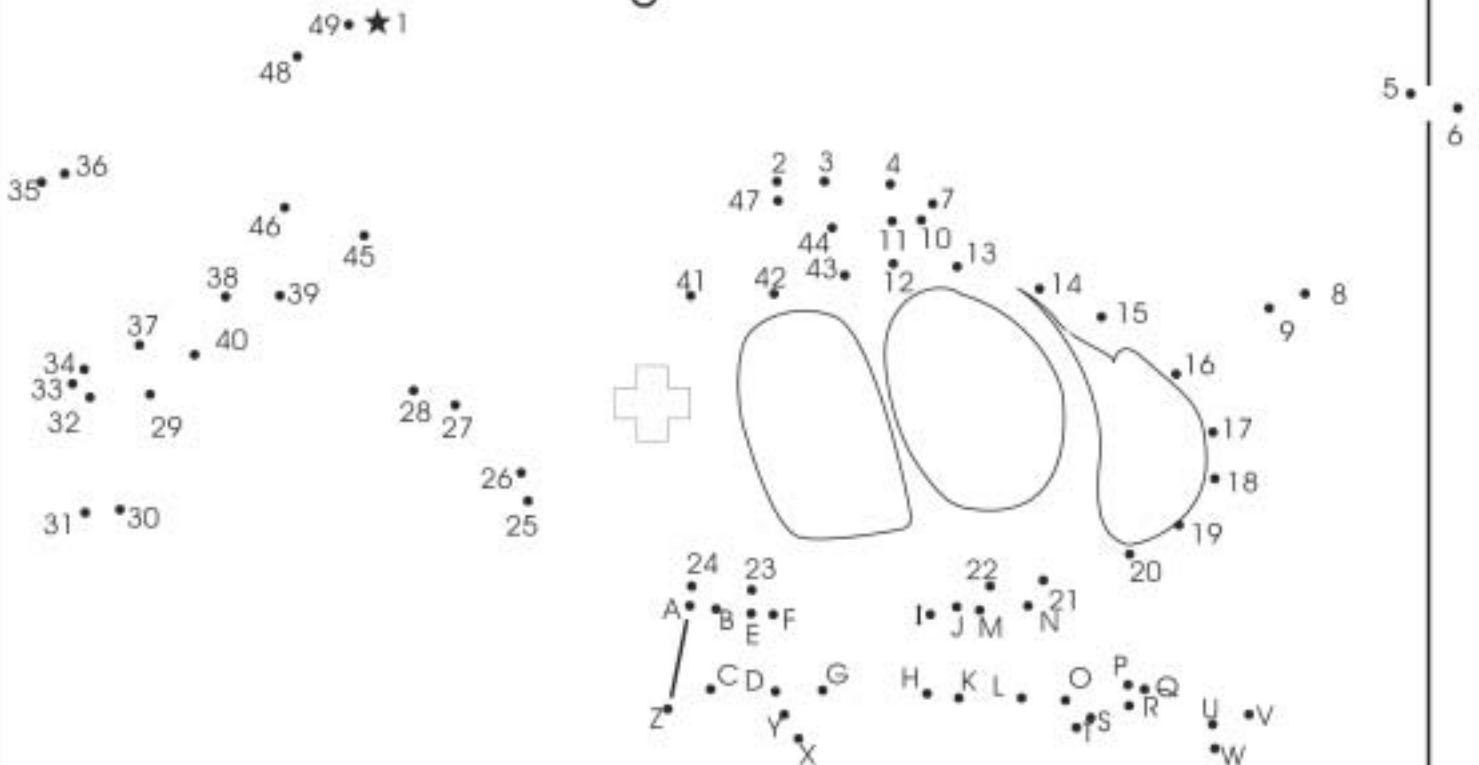

Connect the dots.

1-49 start at the ★, A-Z start at the letter A.

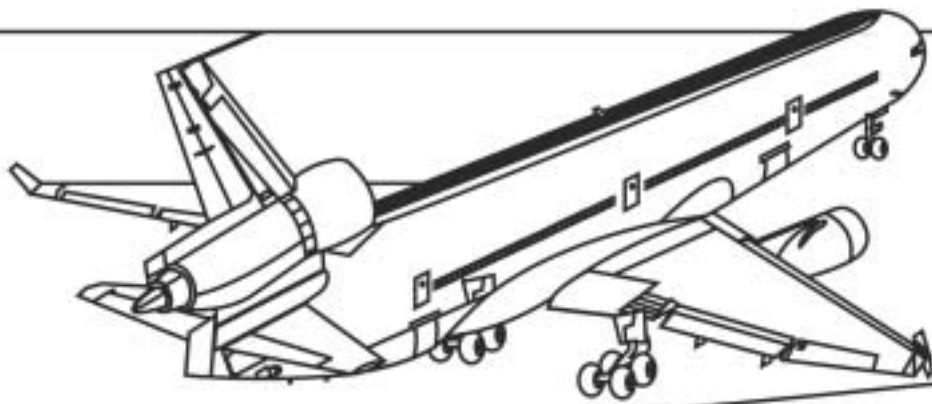

Can you name the things
at this airport?

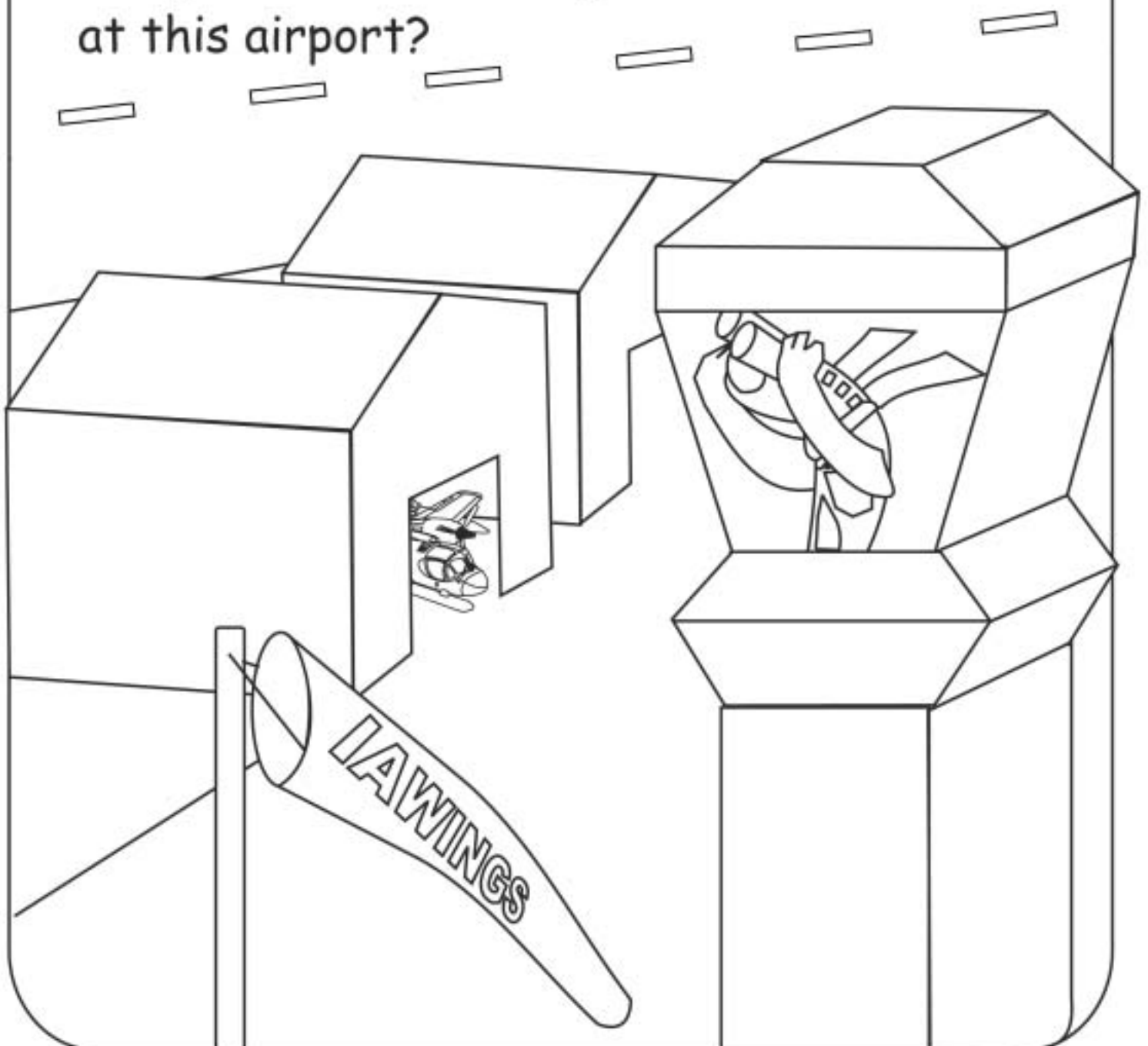

Flying Word Find

E L I A T Y N O I T A I V A
A N T P R H A N G A R I K U
V F A I R P O R T U T X H M
T O K L A N D I N G W A E I
E S E O P S W W O U J T M N
J K O T U R A C O C K P I T
T F F G D Y I Z L W H M J L
S R F U L T R A L I G H T A
V R E D I L G P A N H A Q X
E G A L E S U F B G C W A Z



Airplane
Airport
Aviation
Balloon

Cockpit
Fuselage
Glider
Hangar

Jet
Landing
Pilot
Runway

Tail
Take Off
Taxi
Ultralight

Wing

Color

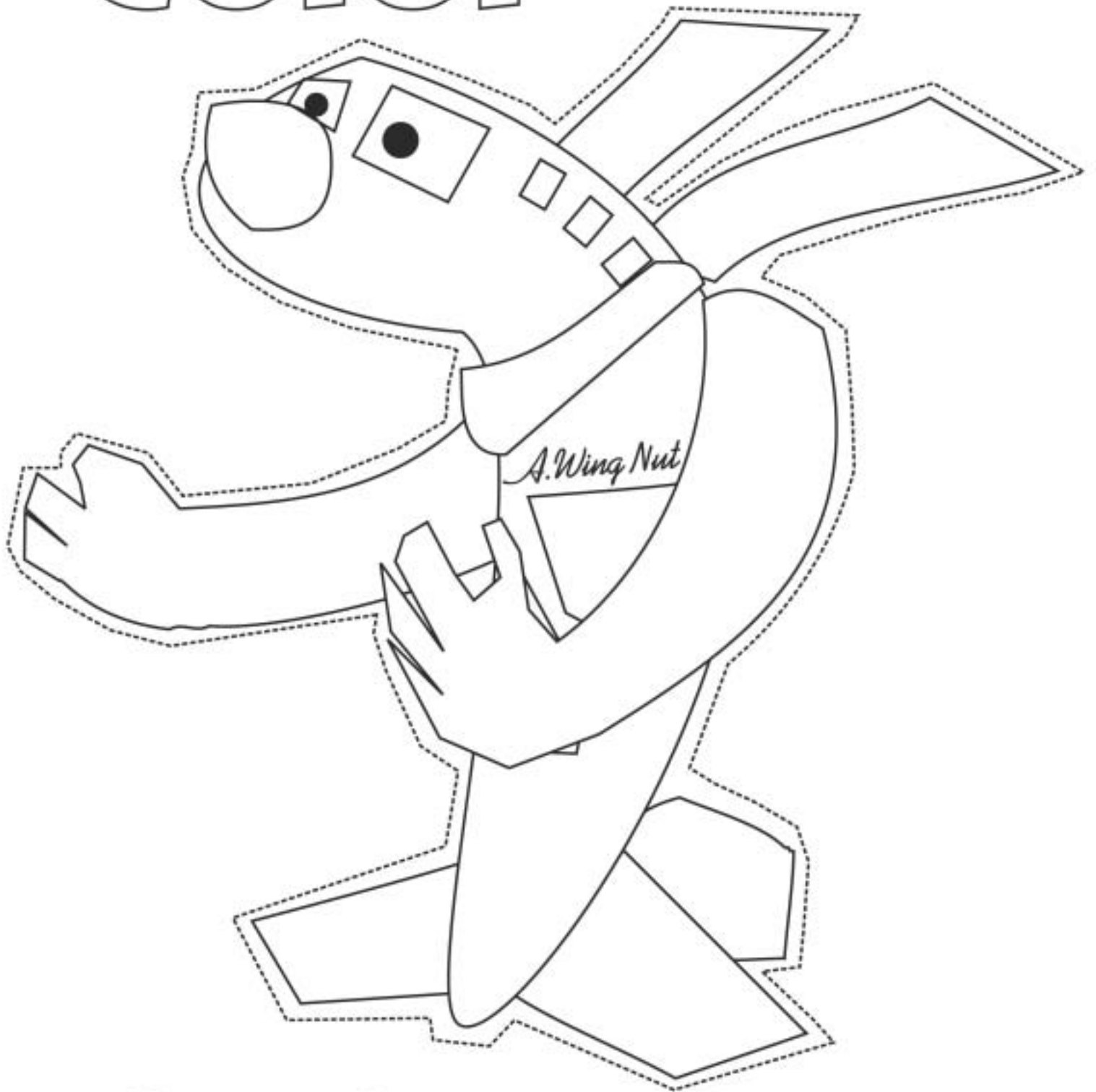

& Cut Out

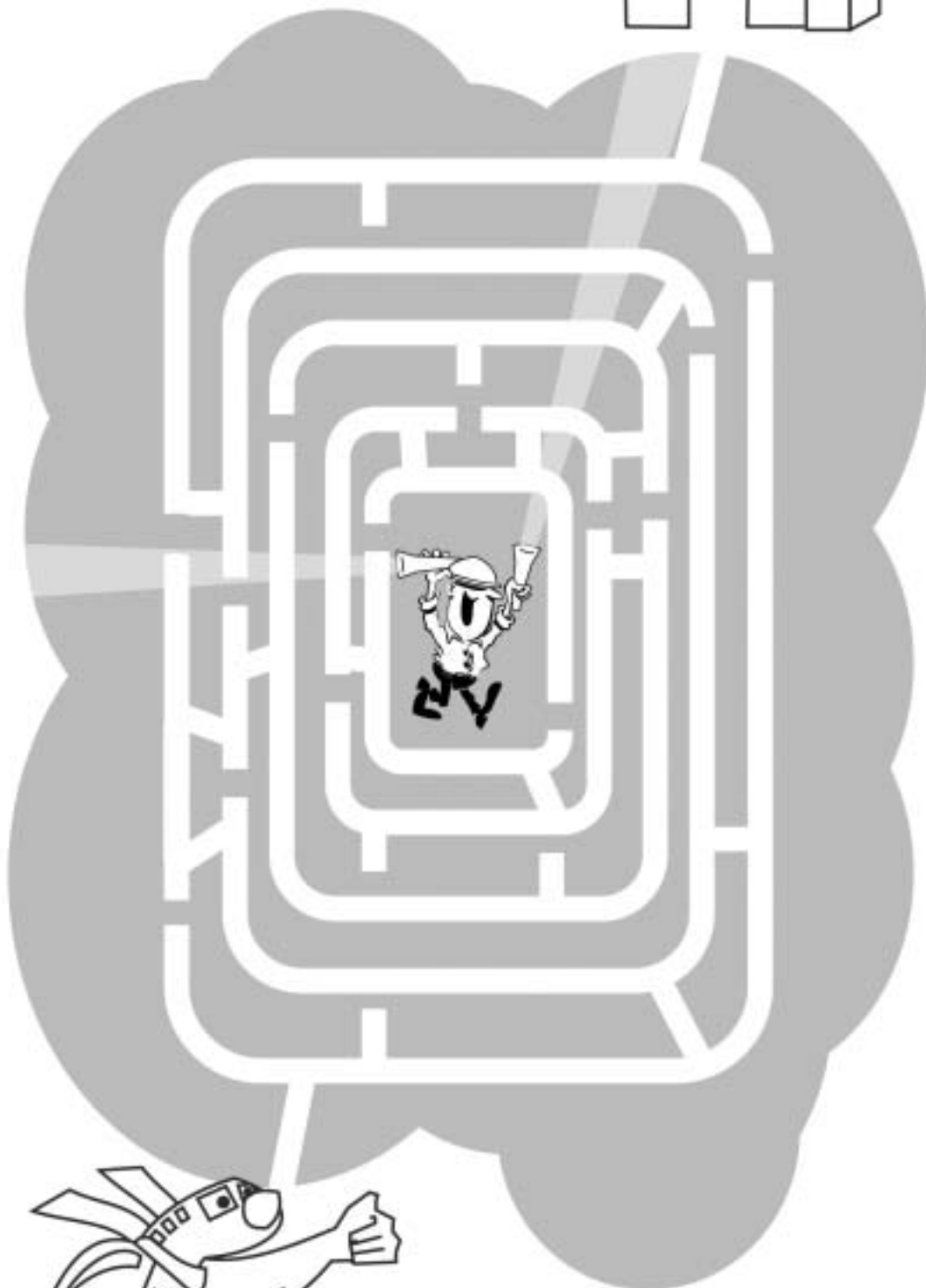

Help A. Wing Nut find the way to the hangar!

WHIRLIGIG

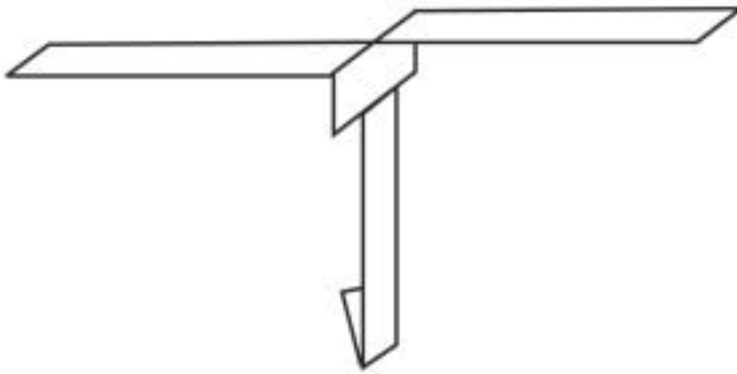

1. Cut along all the solid lines.
2. Fold along the dotted lines; flap A forward and flap B to the back.
3. Fold flaps C and D forward along the dotted lines.
4. Fold along the dotted line E upward to give a weight at the bottom.
5. Now this should look like the drawing at the top.

Drop with weighted end (E) down.

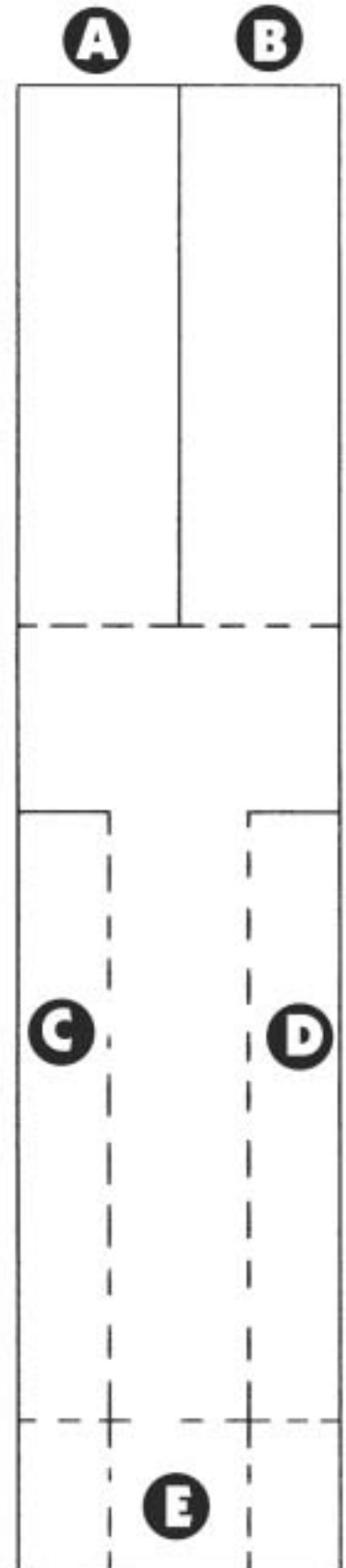

Visit www.iawings.com
to learn more about...

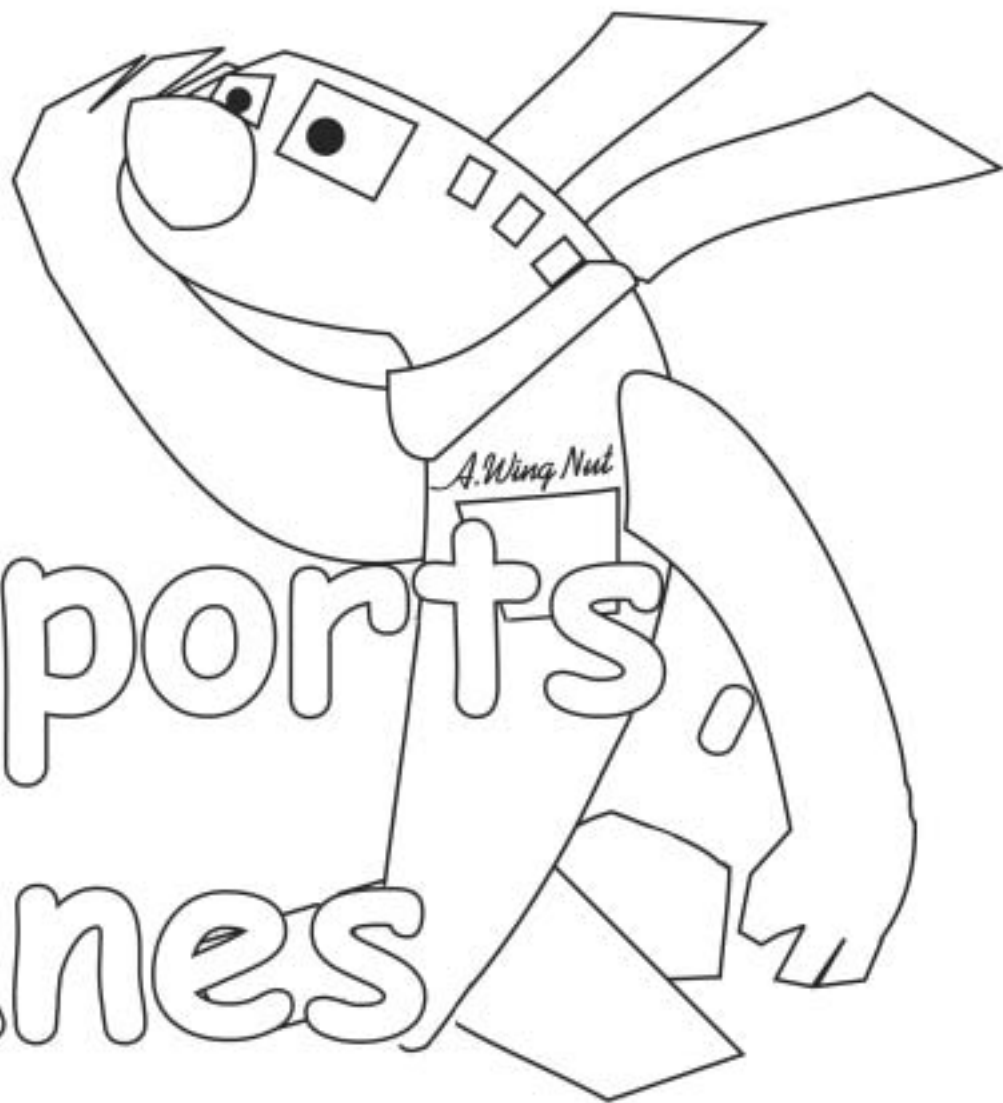

airports,
planes
& flying.



Iowa Department
of Transportation

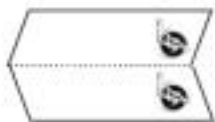

1. Fold sheet in half on dotted line.
2. Fold the short edge of one side down to the first fold. Do this for the other side too.
3. Fold down the new fold you have created to the original fold you made in step one.. Repeat for the other side.
4. Do step three again for both sides.

