

Highway Runoff Study Progress Report

E. Robert Baumann
Principal Investigator

Harvey A. Gullicks
Project Manager

August 1984

ISU-ERI-Ames-85045
Project 1680

Submitted to the
Iowa Department
of Transportation

Department of Civil Engineering
Engineering Research Institute
Iowa State University, Ames

TABLE OF CONTENTS

	<u>Page</u>
LIST OF FIGURES	iv
LIST OF TABLES	v
1. INTRODUCTION	1
2. PROJECT SITE LOCATION AND DESCRIPTION	1
3. SITE SETUP	3
4. MONITORING DATA	10
4.1. Highway Maintenance	10
4.2. Precipitation	11
4.3. Runoff	11
4.4. Groundwater	32
5. SUMMARY	38
6. APPENDIX	40

LIST OF FIGURES

	<u>Page</u>
Fig. 1. Site plan Iowa DOT highway runoff study.	4
Fig. 2. Log of northwest well (NWW).	6
Fig. 3. Log of northeast well (NEW).	7
Fig. 4. Log of southeast well (SEW).	8
Fig. 5. Log of lysimeter boring.	9
Fig. 6. Cumulative rainfall versus time 4/29/84 rainfall event.	19
Fig. 7a. H-flume hydrograph 4/29/84 runoff event.	20
Fig. 7b. Analytical parameter concentrations (copper, Zn, oil and grease, TKN, and COD) versus time 4/29/84 event.	21
Fig. 7c. Analytical parameter concentrations (COND, TS, SS, TS-SS, Cl, Fe, and Pb) versus time 4/29/84 event.	22
Fig. 7d. Consolidation of Figures 7a, 7b, and 7c.	23
Fig. 8. Parshall flume hydrograph 4/29/84 runoff event.	24
Fig. 9. Direction of groundwater flow Iowa DOT highway runoff study. (Range of observations shown as arrows.)	33
Fig. A1. H-flume hydrograph 5/24/84 and 5/25/84 events.	41
Fig. A2. Parshall flume hydrograph 5/24/84 and 5/25/84 events.	42
Fig. A3. Parshall flume hydrograph 6/13/84 event.	42
Fig. A4. H-flume hydrograph 6/14/84 event.	43
Fig. A5. Parshall flume hydrograph 6/14/84 event.	44
Fig. A6. Parshall flume hydrograph 6/16/84 event.	44

LIST OF TABLES

	<u>Page</u>
Table 1. Temperature and precipitation data.	12
Table 2. Report of chemical analysis 2/16/83.	16
Table 3. Report of chemical analysis 5/8/84.	26
Table 4. Report of chemical analysis 12/21/83.	35
Table 5. Report of chemical analysis 4/30/84.	36
Table A1. Report of chemical analysis 6/25/84.	45
Table A2. Summary of hydraulic data for runoff events.	46
Table A3. Report of chemical analysis 7/30/84.	47

1. INTRODUCTION

The focus of highway runoff monitoring programs is on the identification of highway contributions to nonpoint source degradation of surface and groundwater quality. The results of such studies will assist the Iowa Department of Transportation (DOT) in the development of maintenance practices that will minimize the impact of highway transportation networks on water quality while at the same time maintaining public safety.

Highway runoff monitoring research will be useful in developing a basis to address issues in environmental impact statements for future highway network expansions. Further, it will lead to optimization of cost effectiveness/environmental factors related to de-icing, weed and dust control, highway drainage, construction methods, etc.

In this report, the authors present the data accumulated to date with a preliminary interpretation of the significance of the data. The report will discuss the site setup, operational aspects of data collection, and problems encountered. In addition, recommendations are included to optimize information gained from the study.

2. PROJECT SITE LOCATION AND DESCRIPTION

The project study site is located near Ames, Iowa, along Interstate Highway 35, approximately three and one half miles south of Highway 30 in the north-central and central portions of T 83 N, R 23 W, Section 31. The site is near DOT I-35 Station 344+00 where runoff from the north and south is monitored as separate discharges using a dual flow monitoring

station. The flat slope and steep slope areas contributing to the flow drain a section of I-35 between the centerlines of the north and southbound traffic lanes to the median and downstream to culverts leading to the flow monitoring station.

The north drainage area contains 1.70 acres. The south drainage area contains 1.87 acres. Approximately 49 percent of each drainage area is paved. The median ditch grade slopes downward from the north (Station 353+80) to the double 24-inch concrete culvert site (Station 344+00) at approximately 0.24 percent and downward from the south (Station 333+00) to the culvert (Station 343+60) at approximately 2 percent. The topography at the 24-inch culvert discharges is relatively flat, sloping downward to the west and south. Runoff from the southern, steep slope is monitored with an H-flume. Runoff from the northern, flat slope is monitored with a Parshall flume.

Drainage on the east side of the interstate highway from Station 340+00 to Station 366+50 is controlled by the rerouted old Skunk River channel. Any highway-related runoff south of Station 340+00 and north of Station 318+03, excluding median flow north of Station 333+00, reaches the rerouted old Skunk River channel flowing south or a creek flowing east and is not monitored. Drainage along the west side of Interstate 35 from Station 340+00 to Station 366+50 is controlled both by flow in relatively flat ditches and by topographic depressions, channels, and cuts that intersect the ditches near the right of way. From information collected in a topographic survey by the DOT, it appears that runoff from this portion of Interstate 35's west lane and west right of way flows toward the west onto a relatively flat adjacent property and

south into a small creek. Eventual discharge of Interstate 35 runoff in this area is to the present day Skunk River located east of the study site.

Local climatological history and relatively low permeability soils indicate that the 100-year storm may produce median ditch flows up to approximately 8 cubic feet per second (cfs) in the areas proposed as monitoring sites. For normal runoff events, peak flows of 1 cfs to 3 cfs are anticipated.

3. SITE SETUP

Construction at the site began on September 19, 1983. A site plan, Fig. 1, shows the location of all pertinent equipment, structures, and existing site features.

A fiberglass shed to house the flow monitoring/sampling equipment was placed on its foundation on September 19, 1983. The flumes were installed, leveled, planked, and backfilled by September 22. Existing drainage channels from the flumes to the edge of the right of way were improved and seeded on September 23. An adequate free drainage situation exists at both flume locations.

Installation of the flumes and provision of adequate drainage was more difficult than anticipated before construction began because extensive siltation of the west ditch had occurred since the completion of the highway. Up to 12 inches of silt had to be removed to allow flume placement at the culvert flowline elevations. This in turn required

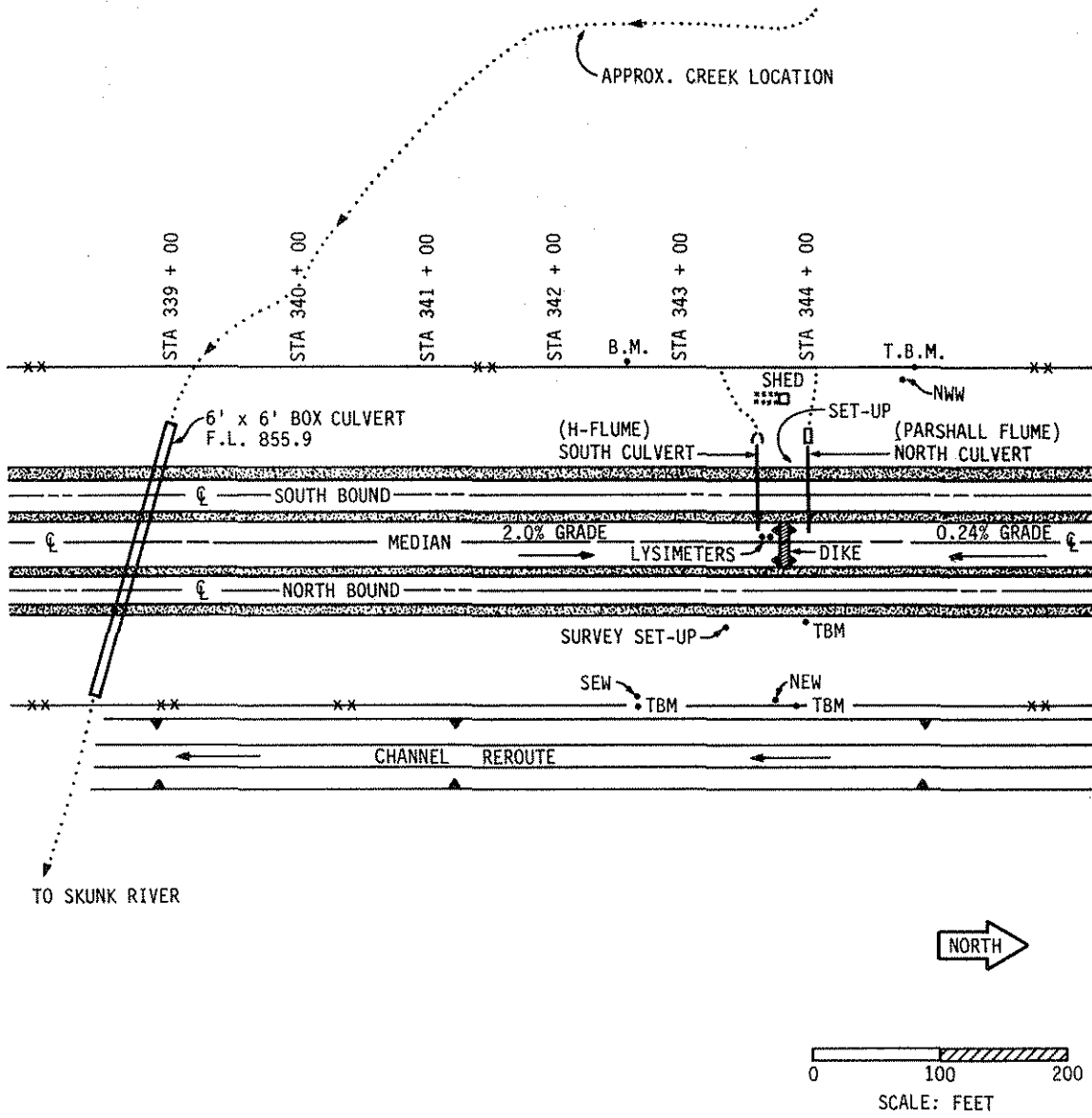

Fig. 1. Site plan Iowa DOT highway runoff study.

drainage improvements. The runoff flow from the southern 2.0 percent grade is monitored at the H-flume installation. The runoff flow from the northern 0.24 percent grade is monitored at the Parshall flume installation.

The groundwater monitoring wells and lysimeters were installed on September 28 and 29, 1983. The installation was directed and supervised by Harvey Gullicks, Project Manager. No significant difficulty was encountered. The boring logs and construction details are given in Figs. 2, 3, 4, and 5.

The rain gauge, flow meter, and automatic samplers arrived between October 17 and October 21, 1983. When ISU personnel began installation on October 24, 1983, it was discovered that the liquid level sample actuators were only 22 feet long. Building placement required by the DOT made this length unsuitable since the building was 40 feet from the flumes. Additionally, the liquid level sample actuator was not compatible with simultaneous use of the flow meter to actuate the sampler. The situation was remedied by ordering a 50-foot liquid level sample actuator for the H-flume installation and using only the flow meter to actuate the Parshall flume sampler.

The H-flume sampler is actuated by the liquid level sample actuator when the water depth in the flume reaches the actuator probe. Then, samples are collected immediately and at regular, timed intervals programmed into the sampler. A Steven's type-F water level recorder records the water level in the flume.

The Parshall flume sampler is actuated on a flow proportional basis by signals from an ISCO 1870 flow meter (bubble type). A sample

CLIENT: IOWA DEPARTMENT OF TRANSPORTATION
 PROJECT: HIGHWAY RUNOFF MONITORING PROGRAM
 PROJECT NO.: 474-20-15-00-1680
 LOCATION: INTERSTATE HWY. 35, STATION 344, SOUTH OF AMES
 DRILLED: SEPTEMBER 29, 1983 BY SHIVE HATTERY AND ASSOCIATES

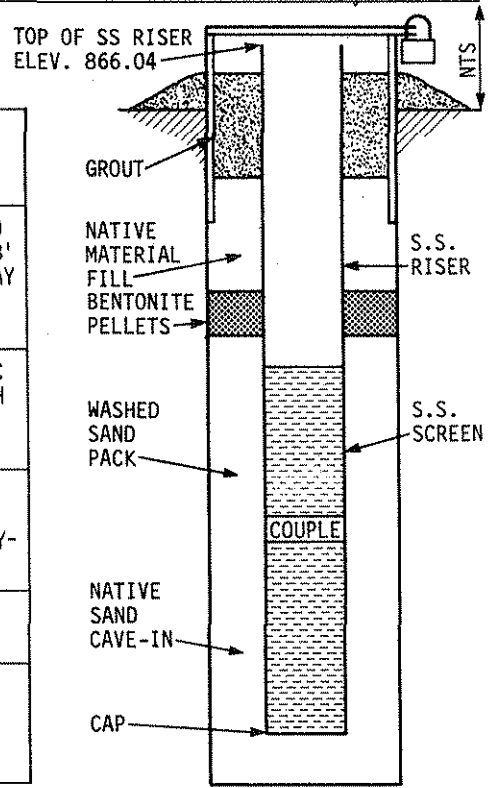
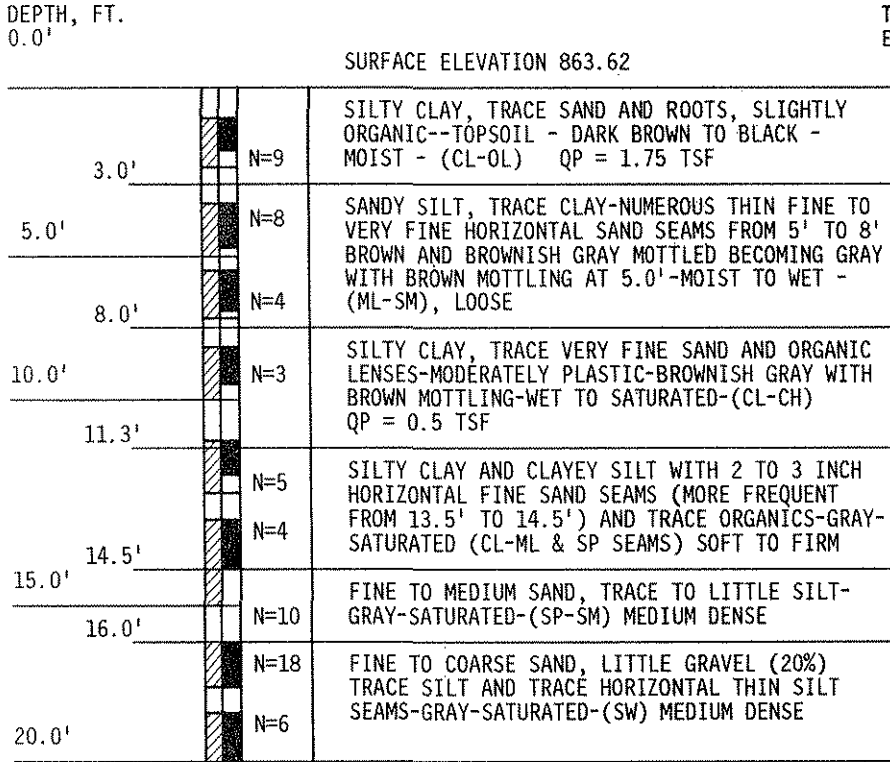

END OF BORING AT 20.0 FEET. BORING AUGERED TO FULL DEPTH USING HOLLOW STEM AUGERS. NO WASH WATER OR DRILLING FLUID USED.

WATER LEVEL DATA*

DATE:	12/19/83	2/1/84	4/11/84	5/3/84	7/20/84
WATER LEVEL:	9.68'	11.58'	8.63'	5.79'	9.50'
GR. WTR. ELEV.:	856.36	854.46	857.41	860.25	856.54

WELL CONSTRUCTION
 RISER - 2" I.D. SCH. 5 STAINLESS STEEL
 SCREEN - STAINLESS STEEL WIRE WOUND NO. 10 SLOT. LENGTH 10.3 FT. INCLUDES 0.4 FOOT WELDED COUPLE
 BOTTOM OF SCREEN - ELEV. 845

DRAWN BY: HAG
 DATE: 12/21/83

*NOTE: ALL WATER LEVELS REPORTED RELATIVE TO THE TOP OF THE S.S. RISER PIPE.

Fig. 2. Log of northwest well (NWW).

CLIENT: IOWA DEPARTMENT OF TRANSPORTATION
 PROJECT: HIGHWAY RUNOFF MONITORING PROGRAM
 PROJECT NO.: 474-20-15-00-1680
 LOCATION: INTERSTATE HWY. 35, STATION 344, SOUTH OF AMES
 DRILLED: SEPTEMBER 28, 1983 BY SHIVE HATTERY AND ASSOCIATES

DEPTH, FT. 0.0'		SURFACE ELEV. 862.78
2.5'	N=11	SILTY FINE TO MEDIUM SAND, TRACE CLAY AND ROOTS, A FEW HORIZONTAL THIN SEAMS OF CLAY-TOPSOIL-BROWN TO DK BROWN-(SM-OL)-MED. DENSE
5.0'	N=13	SILTY CLAY, TRACE SAND & ROOTS-TOPSOIL-DARK BROWN-MOIST TO WET (NR. 6 FT.)-(CL-OL) Q _p = 3.25 TSF PROBABLE ORIG. GRADE AT ~2.5' DEPTH
6.3'		
10.0'	N=6	SILTY FINE SAND (~10-15% SILT), TRACE CLAY AND ROOTS-LT. BROWN TO BROWN-WET-(SM-SP) GRADING TO FINE TO MEDIUM SAND, TRACE SILT-BROWN-SATURATED-(SP-SM) - LOOSE
10.5'	N=2	
14.0'	N=3	FINE TO MEDIUM COARSE SAND, TRACE SILT-GRAY-SATURATED-(SP)-LOOSE A FEW SILT AND CLAY HORIZONTAL SEAMS
15.0'	N=13	FINE TO COARSE SAND, LITTLE GRAVEL (~20%), TRACE SILT-GRAY-SATURATED-(SW)-MEDIUM DENSE
	N=18	
20.0'	N=15	

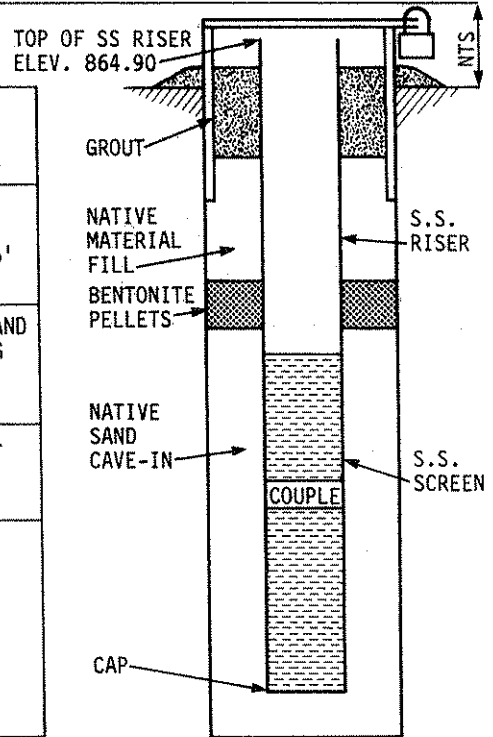

END OF BORING AT 20.0 FEET. BORING AUGERED TO FULL DEPTH USING HOLLOW STEM AUGERS. NO WASH WATER OR DRILLING FLUID USED.

WATER LEVEL DATA*

DATE:	9/29/83	12/19/83	2/1/84	4/11/84	5/3/84
WATER LEVEL:	11.18'	8.96'	10.92'	7.56'	4.79'
CT. WTR. ELEV.:	853.72	855.94	853.98	857.34	860.11

DATE:	7/20/84
WATER LEVEL:	8.46'
GR. WTR. ELEV.:	856.44

WELL CONSTRUCTION
 RISER - 2" I.D. SCH. 5 STAINLESS STEEL
 SCREEN - STAINLESS STEEL WIRE WOUND NO. 10 SLOT. LENGTH 10.3 FEET, INCLUDING 0.4 FOOT WELDED COUPLE.
 BOTTOM OF SCREEN - ELEV. 844

DRAWN BY: HAG
 DATE: 12/21/83

*NOTE: ALL WATER LEVELS REPORTED RELATIVE TO THE TOP OF THE SS RISER PIPE.

Fig. 3. Log of northeast well (NEW).

CLIENT: IOWA DEPARTMENT OF TRANSPORTATION
 PROJECT: HIGHWAY RUNOFF MONITORING PROGRAM
 PROJECT NO.: 474-20-15-00-1680
 LOCATION: INTERSTATE HWY. 35, STATION 344, SOUTH OF AMES
 DRILLED: SEPTEMBER 29, 1983 BY SHIVE HATTERY AND ASSOCIATES

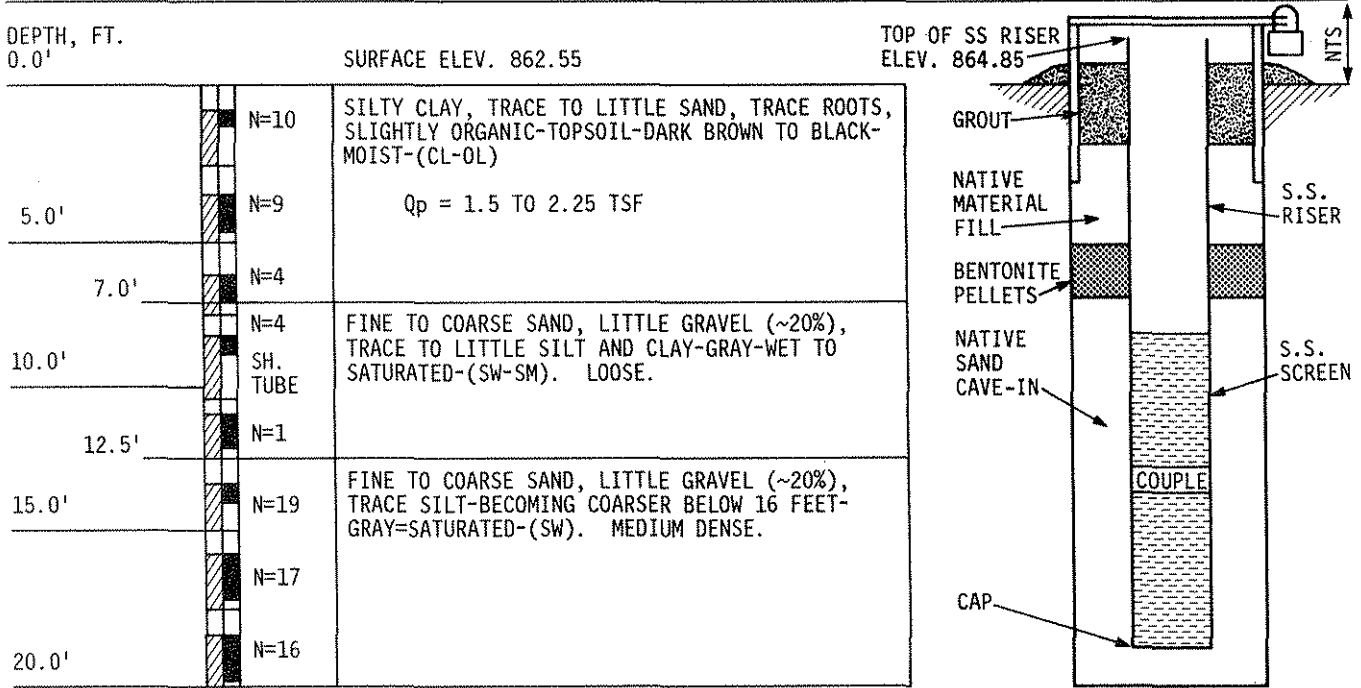

END OF BORING AT 20.0 FEET. BORING AUGERED TO FULL DEPTH USING HOLLOW STEM AUGERS. NO WASH WATER OR DRILLING FLUID USED.

WATER LEVEL DATA*

DATES:	9/29/83	12/19/83	2/1/84	4/11/84	5/3/84
WATER LEVEL:	11.18'	8.92'	10.83'	7.57'	4.79'
GR. WTR. ELEV.:	853.67	855.93	854.02	857.28	860.06
DATE:	7/20/84				
WATER LEVEL:	8.46'				
GR. WTR. ELEV.:	856.39				

WELL CONSTRUCTION
 RISER - 2" I.D. SCH. 5 STAINLESS STEEL.
 SCREEN - STAINLESS STEEL WIRE WOUND NO. 10 SLOT. LENGTH 10.3 FEET INCLUDING 0.4 FOOT WELDED COUPLE.
 BOTTOM OF SCREEN - ELEV. 844

DRAWN BY: HAG
 DATE: 12/21/83

*NOTE: ALL WATER LEVELS REPORTED RELATIVE TO THE TOP OF THE SS RISER PIPE.

Fig. 4. Log of southeast well (SEW).

CLIENT: IOWA DEPARTMENT OF TRANSPORTATION
 PROJECT: HIGHWAY RUNOFF MONITORING PROGRAM
 PROJECT NO.: 474-20-15-00-1680
 LOCATION: INTERSTATE HWY. 35, STATION 344, SOUTH OF AMES
 DRILLED: SEPTEMBER 29, 1983 BY SHIVE HATTERY AND ASSOCIATES

DEPTH, FT.	SURFACE ELEVATION
0.0'	
2.5'	SANDY CLAY, SOME SILT, TRACE GRAVEL - FILL - BROWN-(CL)
4.0'	
5.0'	SILTY CLAY, TRACE TO LITTLE SAND, TRACE ROOTS, SLIGHTLY ORGANIC-TOPSOIL-DARK BROWN TO BLACK - MOIST - (OL-CL)
7.5'	PROBABLE ORIG. GRADE AT 4.0'
10.0'	

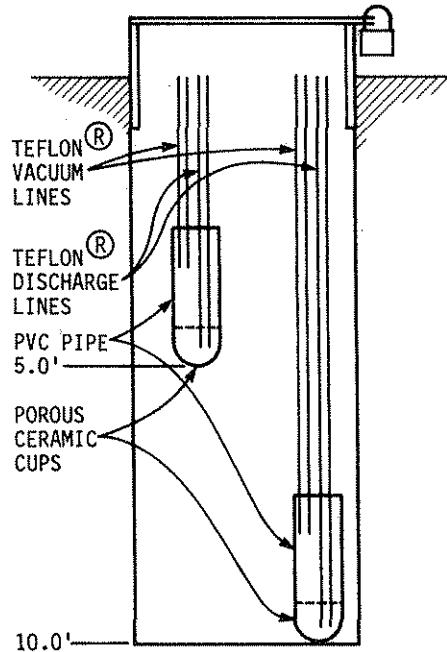

END OF BORING AT 10.0 FEET. BORING AUGERED TO FULL DEPTH USING HOLLOW STEM AUGERS. NO WASH WATER OR DRILLING FLUID USED.

NO WATER ENCOUNTERED WHILE DRILLING PER SHIVE-HATTERY CREW.

LYSIMETER CONSTRUCTION*
 BACKFILL AROUND POROUS CERAMIC CUPS IS OTTAWA SILICA SAND.

FILL ABOVE SILICA SAND IS WASHED SAND.

IMPERMEABLE SEAL AT GROUND SURFACE.

DRAWN BY: HAG
 DATE: 12/21/83

*NOTE: EACH LYSIMETER INSTALLED IN A SEPARATE BORING, RATHER THAN IN ONE DRILLED HOLE.

Fig. 5. Log of lysimeter boring.

is collected each time a programmed volume of runoff passes through the flume.

The equipment was operational but not tested until November 14, 1983. Small precipitation events showed that the timbers used by the DOT to plank the flumes (for safety reasons) were leaching detectable oil and grease on contact with the water. Therefore, ISU personnel proposed that the flume entrances be lined with plastic to minimize water to plank contact. The plastic was installed between November 21, 1983, and January 5, 1984. This appears to have been effective.

4. MONITORING DATA

4.1. Highway Maintenance

De-icing activities during the months of November, December, and January required the application of approximately 1400 pounds of salt to the two traffic lanes comprising the south (steep) drainage area. Approximately 1320 pounds of salt were applied to the two traffic lanes comprising the north (flat) drainage area. Approximately 280 pounds of salt were applied to each of the areas in February and March.

The equivalent salt loading per acre in each of the drainage areas was approximately 750 pounds to 775 pounds per acre prior to the first snowmelt runoff. The annual loading rate was 900 pounds to 940 pounds per acre.

Between January 13 and 24, 1984, the asphaltic concrete patches in the study area were oiled using Styrelf oil.

4.2. Precipitation

Between November 14, 1983, and December 14, 1983, field mice damaged the insulation in the tipping bucket rain gauge. A hole built into the bottom of the gauge housing serving as their entrance was covered. The insulation damage continued to cause problems by interfering with the tipping bucket operation until February 15, 1984, when the erratic rain gauge behavior was solved. Precipitation data collected after February 15, 1984, have been reliable.

Local climatological data from the National Oceanic and Atmospheric Administration augmented with the project manager's daily weather notes will be used to estimate precipitation prior to February 15, 1984. The data will also be used to augment data obtained by the rain gauge at the site subsequent to February 15.

Daily precipitation from November 1, 1984, to the present are shown on Table 1. Temperature patterns are also shown.

4.3. Runoff

Bitter cold and heavy snow precipitation occurred in December 1983. A warming trend occurred between January 3 and 8, 1984, but no runoff occurred at the site during this time. The flumes were completely plugged with snow from the December storms and had to be shoveled out on January 5, 1984. Also, the stilling wells were frozen solid making flow measurement impossible had it been necessary. These problems plagued snowmelt runoff sampling efforts during the spring of 1984 as noted below.

Table 1. Temperature* and precipitation** data.

Date	Nov. 83			Dec. 83			Jan. 84			Feb. 84		
	Precip.	Temp.		Precip.	Temp.		Precip.	Temp.		Precip.	Temp.	
		H.	L.		H.	L.		H.	L.		H.	L.
1	0.62 R	65	51	0.00	22	3	0.06 S	30	17	0.00	40	18
2	0.04 R	64	55	0.00	25	12	0.24 S	27	13	0.00	39	30
3	0.00	62	42	0.00	25	2	0.00	35	14	Tr	38	28
4	0.17 R	46	31	0.00	33	22	0.00	39	24	Tr	37	18
5	0.00	53	30	0.03 S	32	18	0.00	42	23	0.00	29	-5
6	Tr	53	46	0.09 S	21	15	0.00	39	30	0.00	17	-7
7	0.00	56	38	0.00	24	6	0.00	37	22	0.00	24	4
8	0.02 R	55	45	Tr	23	3	0.00	35	22	0.00	41	14
9	0.10 R	52	35	0.00	24	12	0.00	28	20	0.00	44	27
10	0.80 R	36	31	0.00	26	10	0.00	22	-5	0.00	40	31
11	0.00	37	28	0.02 S	33	25	0.00	19	-1	Tr	38	33
12	0.12 R-S	36	29	Tr	33	9	Tr	19	13	0.00	44	36
13	0.15 R	38	31	0.00	29	15	0.08 S	18	3	Tr	37	32
14	Tr	44	37	0.09 S	31	18	Tr	14	3	0.00	52	29
15	Tr	41	34	0.05 S	26	10	Tr	18	2	0.07 R	57	36
16	0.00	40	26	0.01 S	12	-7	Tr	18	6	0.20 R	55	39
17	0.00	48	26	0.03 S	2	-12	Tr	12	-5	Tr	40	32
18	0.00	52	31	Tr	-2	-17	0.00	7	-15	0.97 R	37	22
19	1.76 R	60	48	0.00	-9	-18	0.00	9	-13	0.05 R	37	30
20	0.02 R	58	36	0.00	1	-18	0.00	1	-18	Tr	45	25
21	0.00	43	30	0.15 S	11	-4	0.00	13	-17	0.00	52	26
22	0.00	39	32	0.00	-3	-18	0.00	29	0	0.00	62	31
23	0.41 R-S	37	22	0.00	-11	-18	Tr	32	21	0.00	58	33
24	0.54 R	30	20	0.00	-13	-21	0.03 S	33	14	0.00	43	28
25	0.00	36	10	0.00	-2	-20	0.00	39	14	0.00	48	28
26	0.00	35	26	0.00	15	-7	0.00	37	27	0.00	46	29
27	0.24 R	33	32	0.00	19	14	0.00	28	8	0.00	41	26
28	0.96 R-S	33	27	0.05 S	15	1	Tr	37	17	0.00	33	24
29	0.06 S	29	15	0.00	5	-8	0.00	32	20	0.00	35	18
30	Tr	18	11	0.00	18	-5	0.11 R	27	10			
31				0.00	26	16	0.00	32	8			

12

Site
 Total Precip. 5.81 (Ames data) 0.52 (Ames data) 0.52 (Ames data) 1.29 (site data)

Total Precip. of Ames 5.81 0.52 Note: Frozen soil on 12/4/83 0.52 Note: Frozen soil 1.27 Note: Soil temperatures above freezing on 2/11/84

Note: Precipitation in inches

* Ames temperature data, °F
 ** Tr = trace, R = rain, S = snow

Table 1. Continued.

Date	March 84			April 84			May 84			June 84		
	Precip.	Temp.		Precip.	Temp.		Precip.	Temp.		Precip.	Temp.	
		H.	L.		H.	L.		H.	L.		H.	L.
1	0.00	43	25	0.00			0.00			0.00		
2	0.00	42	27	0.11 R			0.15 R			0.06 R		
3	Tr	44	27	0.78 R			0.10 R			0.00		
4	0.09 S-R	43	28	0.00			0.00			0.26 R		
5	0.00	33	23	0.00			0.00			0.00		
6	0.00	25	2	0.00			0.04 R			0.13 R		
7	0.05 S	24	11	0.03 R			0.04 R			0.45 R		
8	0.01 S	24	8	0.33 R			0.00			0.00		
9	0.00	20	-5	0.02 R			0.00			0.72 R		
10	0.00	32	3	0.00			0.00			0.00		
11	0.10 S	30	6	0.10 R			0.04 R			0.00		
12	0.04 S	23	9	0.18 R			0.00			0.37 R		
13	0.00	29	18	0.09 R			0.00			2.35 R		
14	0.00	36	30	0.05 R			0.00			1.83 R		
15	Tr	36	28	0.04 R			0.05 R			0.00		
16	Tr	32	22	0.00			0.00			0.57 R		
17	0.08 S	33	24	0.00			0.00			0.22 R		
18	0.00	30	23	0.00			0.16 R			0.00		
19	0.20 S	29	24	0.00			0.33 R			0.00		
20	0.02 S	31	25	0.00			0.00			0.00		
21	Tr	34	29	0.70 R			0.00			0.36 R		
22	0.00	38	26	0.11 R			0.30 R			0.06 R		
23	0.00	45	25	0.00			0.00			0.00		
24	0.00	46	26	0.00			0.41 R			0.00		
25	0.00	49	28	0.00			0.92 R			0.01 R		
26	0.03 R	48	32	0.00			0.00			0.39 R		
27	0.00	41	34	0.39 R			0.35 R			0.00		
28	0.00	48	33	0.00			1.52 R			0.00		
29	0.00	45	28	2.08 R			0.00			0.00		
30	0.00	43	26	0.07 R			0.00			0.00		
31	0.00	47	26				0.00			0.00		
Site Total Precip.	0.62 (site data)			5.08 (site data)			4.39 (site data)			7.68 (site data)		
Total Precip. 2 mi. SE of Ames	1.40	Note: Soil temperatures predominantly above freezing		6.84			6.49			12.34		

Note: Precipitation in inches

* Ames temperature data, °F

** Tr = trace, R = rain, S = snow

Brief warming trends occurred from January 24 to 28 and January 31 to February 3. Highs were 35° F to 45° F during the above warming trends. Between February 8 and 15 a warming trend with highs from 40° F to 60° F occurred and melted all snow from the medians. The February 4 snowfall combined with high winds completely plugged the flumes once again making automatic flow measurement and sampling impossible. The stilling wells were still frozen because of the earth backfill required around the flumes for safety reasons. Manual grab samples were obtained on February 9 at both the inlet and ponded discharge from the culverts. Ponding had occurred because the right of way fence-line was still laden with snow preventing free drainage of the median runoff discharged through the culverts.

Warm (33° F to 62° F) weather continued from February 15 to March 4 with brief cold spells and temperatures dropping below freezing at night. Below freezing temperatures and snow occurred from March 4 to March 21. Temperatures were in the 40° F range on March 22 and, generally, the temperatures have remained above freezing since then. The frozen stilling wells were freed of ice on April 4, 1984, making the site completely operational.

During the month of April, above average amounts of precipitation occurred including a significant runoff event on April 29. Conditions during this event allowed ISU personnel to collect excellent data. The project manager was on site from the beginning of the event until its completion. Thus, manual as well as automated data were gathered. The manual and automated flow measurement data were in excellent agreement.

Officially, Ames received only 0.5 inch more precipitation than the average in the first three months of 1984. However, precipitation for April and May were 6.84 inches and 6.49 inches, respectively, well above the normal values of 2.49 inches and 4.28 inches, respectively. In addition, the precipitation in June also set a new record; 12.34 inches were recorded in Ames versus the average of only 5.21 inches.

Precipitation recorded at the site has been as follows:

January through March	2.43 inches
April	5.08 inches
May	4.39 inches
June	7.68 inches

Although this is significantly below that recorded in Ames, it is still well above average.

4.3.1. Snowmelt Data

The first spring thaw to contribute surface runoff because of snowmelt occurred from February 8 to February 15, 1984. Runoff from snowmelt probably began late on February 8. Two random grab samples of the runoff from each flume were obtained on February 9. The analytical results are shown in Table 2. The samples are identified as follows. HI (steep slope) and PI (flat slope) represent H-flume and Parshall flume influent from the median, respectively. HO and PO represent ponded water samples downstream from the H-flume and Parshall flume outlets, respectively. The ponding downstream from the flume outlets was caused by snow collecting along the right of way fenceline that had not melted at the same rate as that in the right of way and median.

ENGINEERING RESEARCH INSTITUTE
 ANALYTICAL SERVICES LABORATORY
 REPORT OF CHEMICAL ANALYSIS

16

TO: HARVEY GULLICKS
 PROJECT: DOT 0209
 DATE: FEB 16, 1983
 BY: *J. G. Gault*

Table 2. Report of chemical analysis 2/16/83.

DOT 0209	HI	HO	PI	PO	UNITS
COND	2910	2870	580	530	UMHO/CM*
TOT SOLIDS	173	****	328	****	MG/L**
SUSP SOLIDS	8.5	****	21	****	MG/L
CHLORIDE	46.1	46.8	136	127	MG/L
NO3+NO2-N	.06	****	.19	****	MG/L AS N
KJEL-N	1.41	****	2.37	****	MG/L AS N
TOTAL P	.28	****	.41	****	MG/L AS P
COD	21.8	****	43.2	****	MG/L
TOC	13	11	19	14	MG/L
TOT CU	6.8	6.6	5.0	5.0	UG/L***
TOT FE	28.7	75.7	62.5	95.4	UG/L
TOT PB	9.8	9.2	7.7	9.5	UG/L
TOT ZN	16	15	6.8	7.3	UG/L
pH		7.03			

* micromhos per centimeter

** milligrams per liter

*** micrograms per liter

Ponding of runoff, however, occurs naturally at the site only a short distance beyond the right of way in any case.

The snowmelt runoff from the flat median (PO and PI) had substantially higher concentrations of chloride than that of the steeper median (HO and HI). This may be a result of the first flush phenomenon since the highly soluble chloride would be transported rapidly with the first runoff. Runoff was observed to be more complete on the steeper slope at the time of sampling. The chloride concentration in the flat median runoff was approximately half the Environmental Protection Agency (EPA) drinking water standard of 250 mg/l. It is likely that the first flush concentrations were substantially higher than 125 mg/l and may have exceeded the drinking water standard.

Snowmelt in February 1984, while it occurred in a relatively short time, did not create large flow rates through the flumes at the site. Although the flow measurement equipment was not operational, the authors observed a fairly continuous flow rate of 0.1 cfs to 0.2 cfs based on visual observations. As a result, suspended solids loadings were low. Concentrations of parameters which may be associated with suspended solids loadings were also fairly low, notably the metals and oxygen demand. The Kjeldahl nitrogen level, which is likely to be largely organic nitrogen based on the Chemical Oxygen Demand (COD) results, was significant. However, it is unlikely that excessive levels of free ammonia exist (reference Sawyer/McCarty, page 445).

Snowmelt in March 1984 was not sampled because of the nonoperational status of the flow measurement equipment.

4.3.2. April 29, 1984, Runoff Event

The April 29, 1984, rainfall event was preceded by light showers from 11:45 a.m. to 1:45 p.m. The heavy rainfall began at 1:45 p.m. and continued with some variation in intensity until 5:12 p.m. Approximately 1.60 inches of rain fell between 1:45 p.m. and 5:12 p.m. for an average intensity of about 0.43 inch per hour. The intensity after 2:55 p.m. was about 0.52 inch per hour. The range of intensities during the event was from about 0.1 inch per hour to 0.6 inch per hour. Cumulative rainfall versus time is shown in Fig. 6.

Figures 7a and 8 show the hydrographs for the H-flume (collecting runoff from the steeper slope median) and the Parshall flume (collecting runoff from the flat median), respectively. Notice that the two flumes reached peak flows at nearly the same time, but that the steeper slope (H-flume) was considerably more responsive to changes in rainfall intensity. Actually, two separate peaks occurred for the steeper slope because of a brief reduction in rainfall intensity at about 2:20 p.m.

The peak flow rate recorded by the H-flume was 1.37 cfs and existed only momentarily. The peak flow recorded by the Parshall flume was 0.95 cfs. The basin lag time for the hydrographs is the time from the center of mass of the rainfall to the peak. Thus, for the Parshall flume watershed the basin lag time was about 74 minutes. For the H-flume watershed, the basin lag time was 40 minutes to 50 minutes, based on the data of the three separate peaks on the hydrograph. Total runoff from the flat median area was approximately 9,800 cubic feet or 1.59 inches per acre from 1:45 p.m. to 8:00 p.m. Total runoff from the steeper slope was approximately 8,200 cubic feet or 1.21 inches per

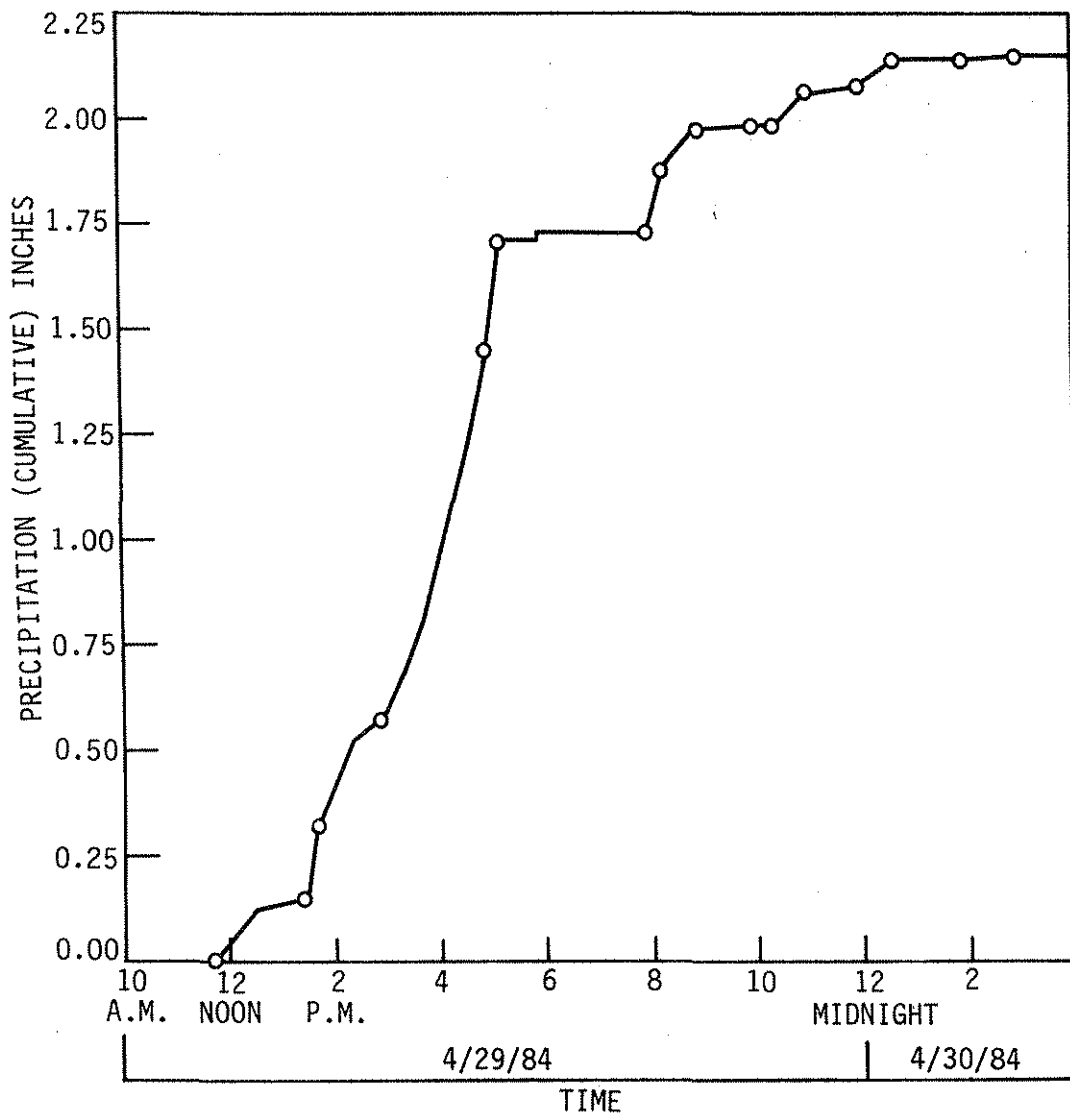

Fig. 6. Cumulative rainfall versus time 4/29/84 rainfall event.

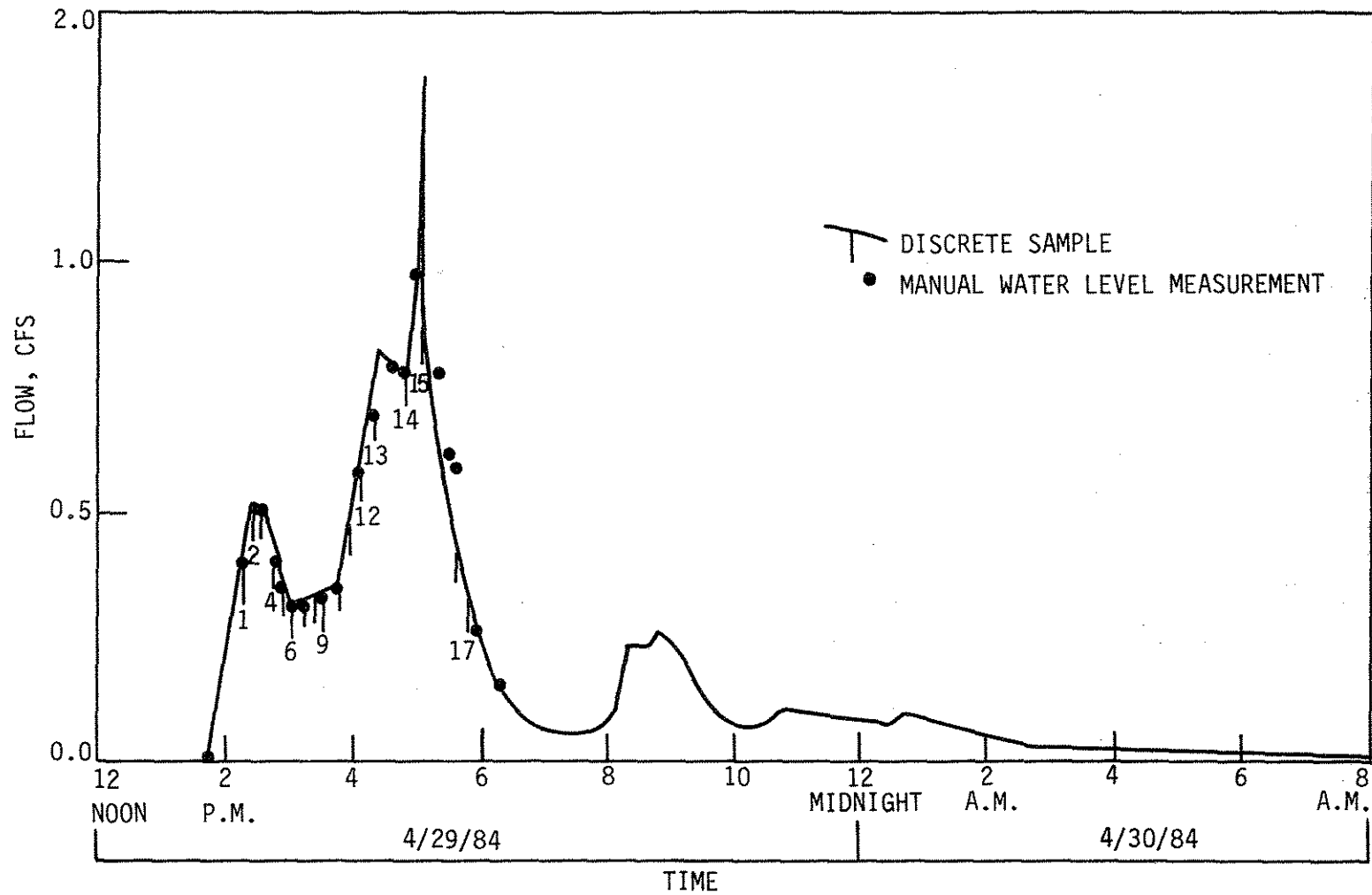

Fig. 7a. H-flume hydrograph 4/29/84 runoff event.

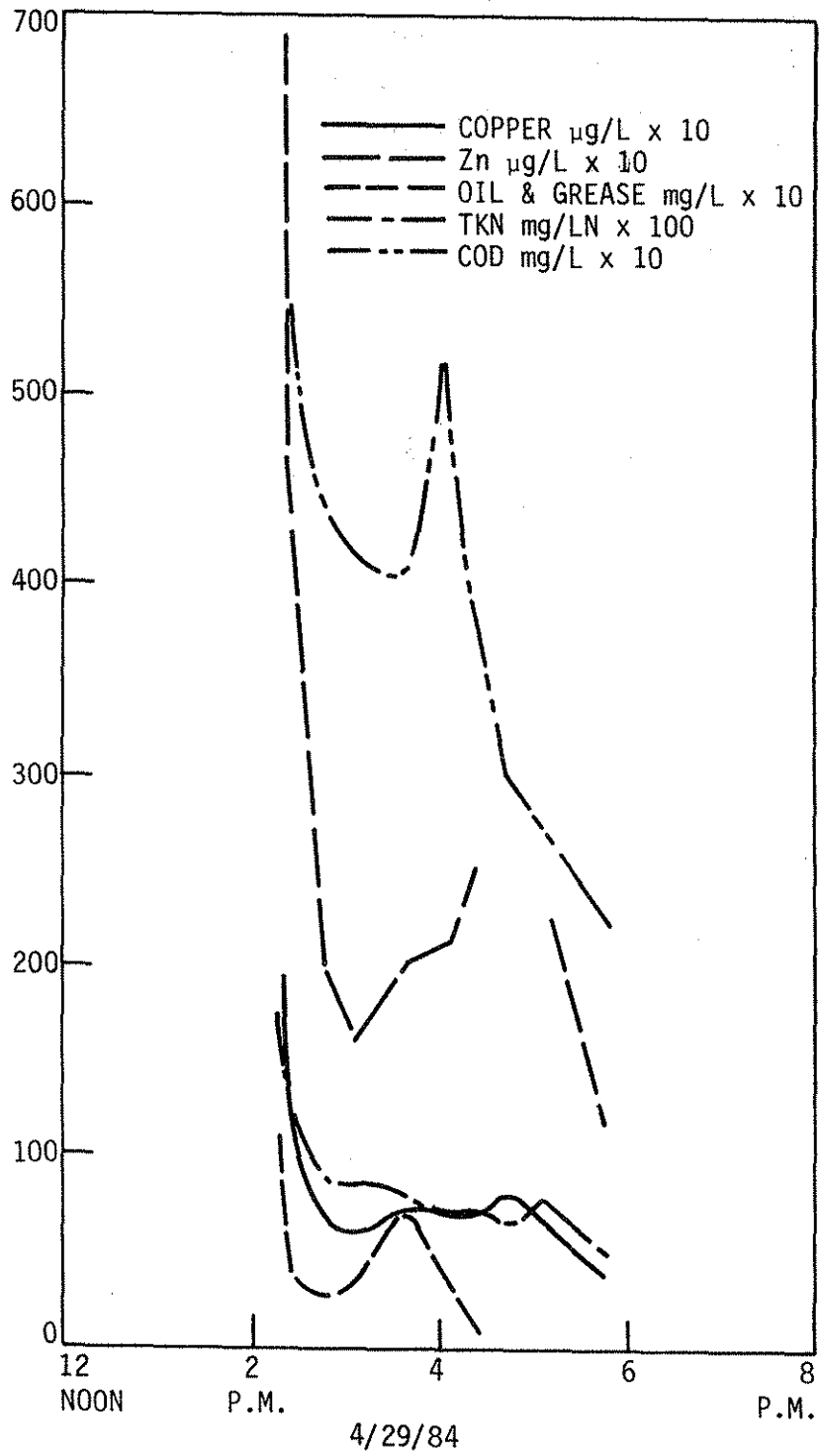

Fig. 7b. Analytical parameter concentrations (copper, Zn, oil and grease, TKN, and COD) versus time 4/29/84 event.

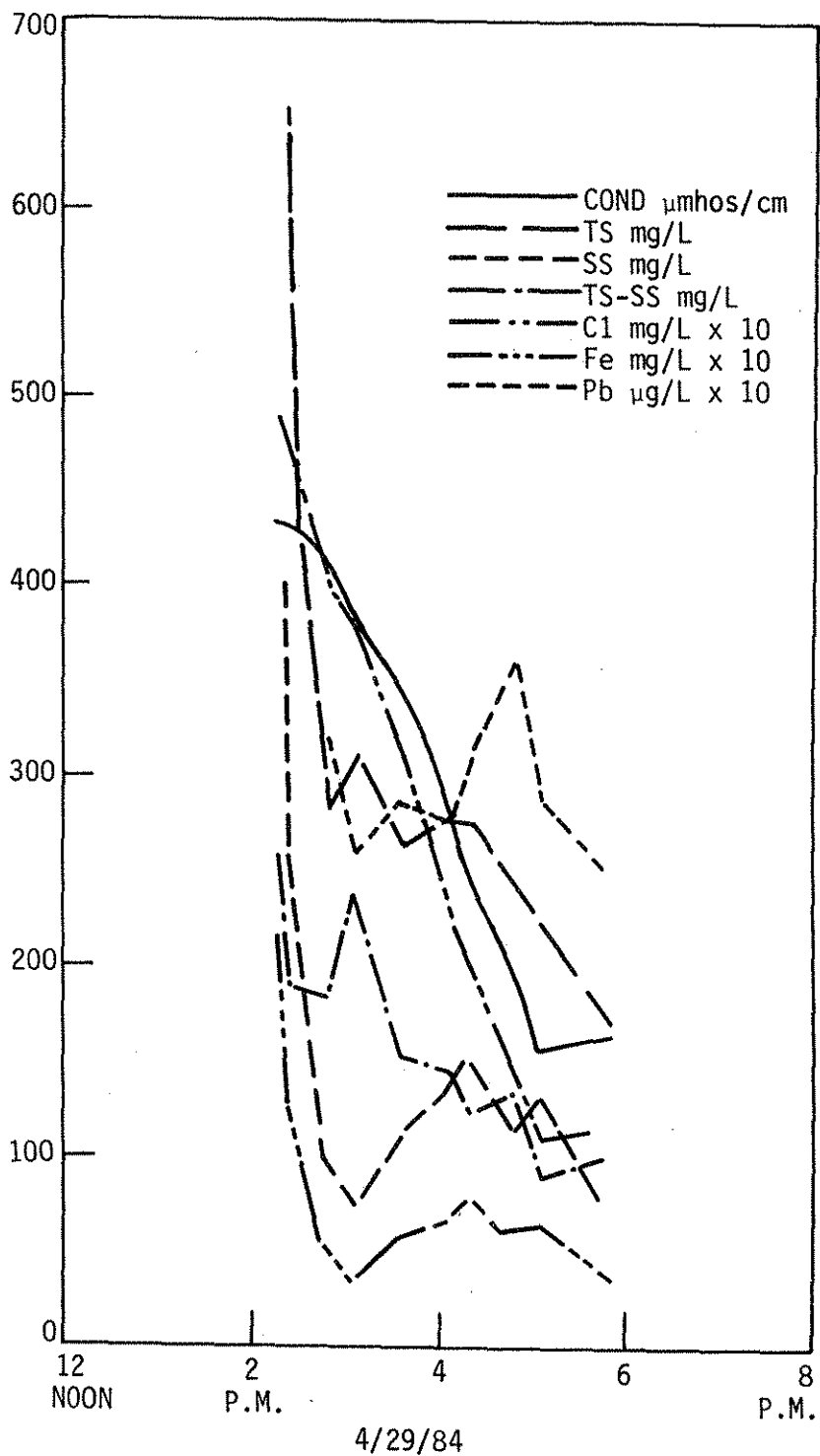

Fig. 7c. Analytical parameter concentrations (COND, TS, SS, TS-SS, Cl, Fe, and Pb) versus time 4/29/84 event.

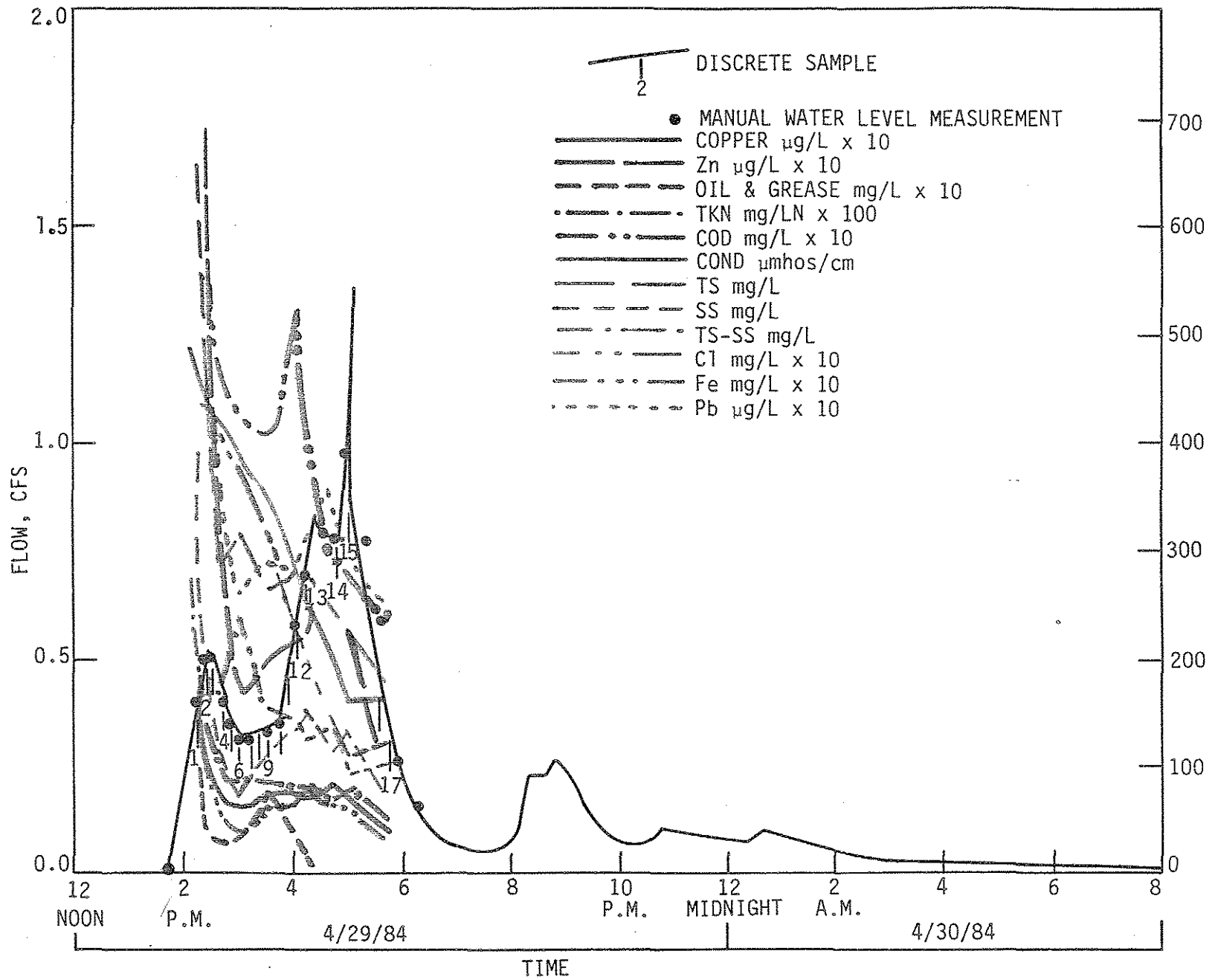

Fig. 7d. Consolidation of Figures 7a, 7b, and 7c.

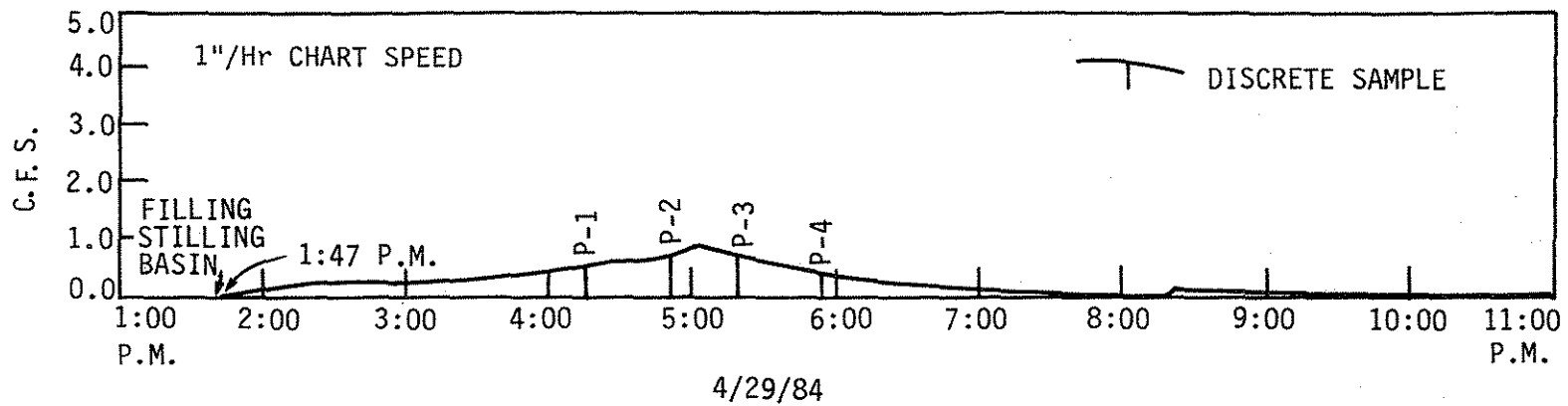

Fig. 8. Parshall flume hydrograph 4/29/84 runoff event.

acre from 1:45 p.m. to 8:00 p.m. The relative volumes of runoff from each area was undoubtedly the result of a higher degree of saturation in the flat slope soils.

Runoff samples were collected at discrete time intervals by the ISCO samplers. Four samples were collected from the Parshall flume. Sixteen samples were collected from the H-flume. In addition, one manual sample, sample 17, was collected from the H-flume. The chronological locations of the samples are shown on the hydrographs, Figs. 7a and 8. H-flume samples 1, 2, 4, 6, 9, 12, 13, 14, 15, and 17 were analyzed. Parshall flume samples P-1, P-2, P-3, and P-4 were analyzed. The list of analytical parameters and results are shown in Table 3. The H-flume sample analyses were also plotted chronologically to show trends related to the peak flow; see Figs. 7b, 7c, and 7d.

Notable correlations of flow and analytical parameter values for the H-flume samples are:

- 1) The highest value for all parameters occurred in the first sample representing a first flush phenomenon.
- 2) Chloride and conductivity values both exhibited decreasing approximately straight line behavior.
- 3) The metals (Fe, Pb, Cu, and Zn), total solids (TS), and suspended solids (SS) all exhibited peaks coinciding approximately with the peak flow. The value of total solids less suspended solids, however, was constantly decreasing. Thus, metals concentrations appear to be related primarily to suspended solids loading.

ANALYTICAL SERVICES LABORATORY

REPORT OF CHEMICAL ANALYSIS

TO: HARVEY GULLICKS
 PROJECT: DOT 0430
 DATE: MAY 8, 1984
 BY: *D. Schoeller*

Table 3. Report of chemical analysis 5/8/84.

DOT 0430	1	2	4	6	9	12	13	14	15	17	P1	P2	P3	P4	UNITS
PH	8.10	8.05	8.04	8.04	8.04	7.93	8.00	8.04	8.05	7.91	7.84	7.98	7.93	7.94	-LOG H+
COND	433	433	415	384	346	285	249	199	158	166	248	192	172	172	UMHO/CM*
TS	658	452	282	312	262	280	280	246	224	172	186	151	213	146	MG/L**
SS	399	260	100	74	110	136	156	114	134	72	59	44	28	23	MG/L
CL	49.0	45.7	40.0	38.0	30.9	22.4	20.3	15.0	10.8	11.6	20.9	14.8	12.5	11.2	MG/L
NO3+NO2N	.17	.12	.13	.07	.07	.08	.08	.11	.06	.05	.07	.07	.06	.07	MG/L N
TKN	1.80	1.32	.86	.85	.76	.70	.74	.64	.76	.49	.66	.66	.47	.49	MG/L N
TOT P	.41	.33	.17	.15	.19	.19	.22	.20	.22	.15	.15	.12	.11	.075	MG/L P
COD	72.4	55.5	46.0	41.7	40.4	52.0	40.0	29.5	27.2	22.5	34.2	25.4	22.5	20.9	MG/L
TOC	22	19	16	14	13	13	12	11	9.4	7.4	11	9.2	9.8	7.8	MG/L
OIL&GR	11	3.8	2.6	3.4	7.8	3.2	<2	<2	<2	<2	14	2.4	<2	<2	MG/L
F. COLI	13	****	27	****	30	****	****	>1100	****	****	>125	>980	****	****	ORG/.1L
F. STREP	>2000	****	>2000	****	>2000	****	****	>2000	****	****	>200	>2000	****	****	ORG/.1L
TOT CU	19.3	12.1	6.2	5.9	7.1	6.6	6.6	8.0	6.7	3.7	4.3	3.3	3.5	2.1	UG/L***
TOT FE	21.5	12.7	5.04	3.88	5.99	6.55	7.58	6.18	6.23	3.05	1.79	1.39	1.03	.87	MG/L
TOT PB	78	51	32	26	29	28	31	36	29	25	9.8	10.0	7.5	6.6	UG/L
TOT ZN	101	47	20	16	20	21	24	127	23	12	22	8.6	6.1	5.1	UG/L

* micromhos per centimeter

** milligrams per liter

*** micrograms per liter

Worm
in Sample
14

26

- 4) Fecal streptococci and fecal coliform analyses indicate an animal (nonhuman) source.
- 5) All analytical parameter values were lower in the Parshall flume runoff than in the H-flume runoff. Furthermore, trends relating flow rate to parameter concentrations were not evident, except for the first flush phenomenon.
- 6) First flush sample parameter values were occasionally in excess of the EPA drinking water maximum contaminant levels.

The pH of the steeper hill runoff was of the order of 7.9 to 8.1, slightly higher than that of the flat median runoff. This is likely because of the buffering effect of the suspended sediment load differences. Conductivity and chloride in the runoff appeared to be related. Chloride levels observed in the first flush were elevated above background levels. The chloride levels observed during this runoff event were, however, substantially lower than those observed in random grab samples of snowmelt runoff collected on February 9, 1984.

Highway maintenance and operations do not appear to contribute significant amounts of nitrogen and phosphorus to surface waters at the test site. Oil and grease were observed to be significant in the first flush. It was also observed that oil and grease levels may fluctuate significantly. This may be because of flushing of oil and grease as "rafts" of contaminants rather than by discrete particle flushing. Total organic carbon (TOC) and chemical oxygen demand (COD) were elevated above background levels in the first flush samples. COD also exhibited a secondary peak in concentration that does not appear to be directly related to the peak flow or suspended sediment load.

Based on examination of the runoff data, the authors have drawn the following preliminary conclusions:

- 1) The primary contaminants contributed to surface waters by the I-35 highway runoff are metals, chloride, oil and grease, and an elevated oxygen-demand.
- 2) The suspended sediment load is directly correlatable with metals concentrations in the highway median runoff based on plots of suspended solids versus metal concentrations. Chloride, oil and grease, and oxygen demand values may be affected by suspended solids loading but do not exhibit a directly correlatable relationship.
- 3) Reduction of highway runoff impacts depends to a large extent on suspended solids reduction. This may be accomplished by the following means:
 - a) maintaining vegetative cover,
 - b) reducing median and right of way mowing activities,
 - c) repairing turf damage from vehicular and construction activities,
 - d) maintaining strict sediment retention procedures at construction sites,
 - e) evaluating the quantity and gradation of de-icing materials used, and
 - f) considering median and right of way grading (dikes and terracing slopes) or retarding (low, narrow rip rap strips on intervals) structures in some cases.

Additional runoff events occurred in May and June. The runoff flow rate from some events was recorded and the runoff was sampled. For some events, however, operational and equipment problems prevented complete data collection. For these events, the data collected will be evaluated to maximize the interpretation of runoff events in which samples were collected and analyzed. This information is being processed and will be included in a later report.

There have been two major operational and equipment malfunctions during the warmer weather monitoring program. First, earthworm penetration of the ISCO flow meter bubble tube negated some of the Parshall flume hydrograph data. This problem has been corrected by surrounding the tube with wire mesh. Secondly, the mechanical clock used in the Steven's recorder has occasionally stopped, presumably because of humidity build-up or because of a rough gear tooth. Another Steven's recorder has become available which will be substituted for the one currently used.

In order to gather more hydrological data from the steeper slope drainage area, Iowa State University plans to install the ISCO flow meter bubble tube in the H-flume so that the runoff flow from the 2 percent grade is monitored continuously with fewer mechanical malfunctions. Excellent data has been collected from the flat (0.24 percent) drainage area to date and is deemed to be sufficient from a hydrological evaluation standpoint.

Data in the Appendix of this report regarding the May and June runoff events should be viewed as preliminary and subject to revision. See Tables A1 and A2 as well as Figures A1, A2, A3, A4, A5, and A6 in

the Appendix. However, on a preliminary basis, it is the authors' opinion that the following statements can be made:

1. For unsaturated topsoil conditions, the basin lag times for the two drainage areas varies with the intensity of the rainfall, the duration of the rainfall, and the slope of the drainage area.
 - a) For rainfall intensities of 0.1 inch per hour (long duration) to 1.6 inches per hour (short duration) and unsaturated topsoil conditions, the basin lag time for the steeper (2 percent) slope may vary from 40 minutes to 400 minutes.
 - b) For rainfall intensities of 0.1 inch per hour (long duration) to 1.6 inches per hour (short duration) and unsaturated topsoil conditions, the flat (0.24 percent) grade basin lag time varies less than the basin lag time of the steep (2.0 percent) grade. For the events observed, an average event intensity was used to determine the basin lag time. This situation is valid because the short duration, high intensity precipitation did not cause corresponding peaks on the flat slope hydrograph that were distinguishable from the overall event peak. Typical basin lag times were from 110 minutes to 260 minutes for unsaturated conditions.
2. For saturated topsoil conditions, the basin lag times for the two drainage areas were nearly identical for high intensity precipitation of substantial duration (greater than one quarter hour).

3. For high intensity precipitation of greater than one quarter hour duration and saturated topsoil conditions, the basin lag times generally range as follows:
 - a) 0.24 percent slope--13 minutes to 35 minutes
 - b) 2.0 percent slope--~35 minutes (one event only 6/14/84)
4. For low to medium intensity (~0.1 inch per hour to 0.6 inch per hour, medium to long duration) precipitation and saturated topsoil conditions, the basin lag times generally ranged as follows:
 - a) 0.24 percent slope--70 minutes to 110 minutes
 - b) 2.0 percent slope--35 minutes to 70 minutes
5. For saturated topsoil conditions runoff in inches per acre is virtually identical to precipitation in inches per acre for all but the lowest of rainfall intensities.
6. For unsaturated topsoil conditions, the ratio of the runoff in inches to the total event precipitation in inches was observed to range from about 0.2 to 0.8 with 0.5 to 0.7 being common ratios for overall events.
7. For precipitation intensities of 1.5 inches per hour to 1.8 inches per hour and saturated soil conditions, peak flows of 0.8 cfs to 3.87 cfs were observed for the steep slope. Peak flows of 0.55 cfs to 2.6 cfs were observed for the flat slope. The flat slope to steep slope peak flow ratios were generally about 0.52 to 0.69 for most storm events. However, the ratio was as high as 0.9 for the June 13, 1984, runoff event.

4.4. Groundwater

The site is underlaid by a shallow alluvial aquifer consisting primarily of fine to coarse sand and approximately 20 percent gravel. The aquifer is overlaid by 6 feet to 10 feet of lower permeability soils and topsoil. Three stainless steel monitoring wells and two lysimeters were installed at the site. The locations of these installations are shown on Fig. 1. The detailed boring logs and installation details are shown in Figs. 2, 3, 4, and 5.

Because of the flat site terrain, ponding of runoff frequently occurs just west of the highway. Thus, significant downward percolation of runoff to the aquifer occurs. The relative variability and thickness of the less permeable surface soils and the probable variation of their extent and integrity presents a substantial potential for groundwater contamination in the event of a spill or long-term accumulation of contaminated runoff.

The direction of groundwater migration at the site is somewhat variable depending on recent climatological conditions and water levels in surface waters (i.e., the channel reroute and the creek) located adjacent to the site. Water levels have been monitored at the three well locations and indicate a northwest to southeast migration of groundwater at the site. The range of observed flow directions with variations in time and conditions is shown on Fig. 9. The best estimate of the flow direction nearly bisects the angle included by the observed range.

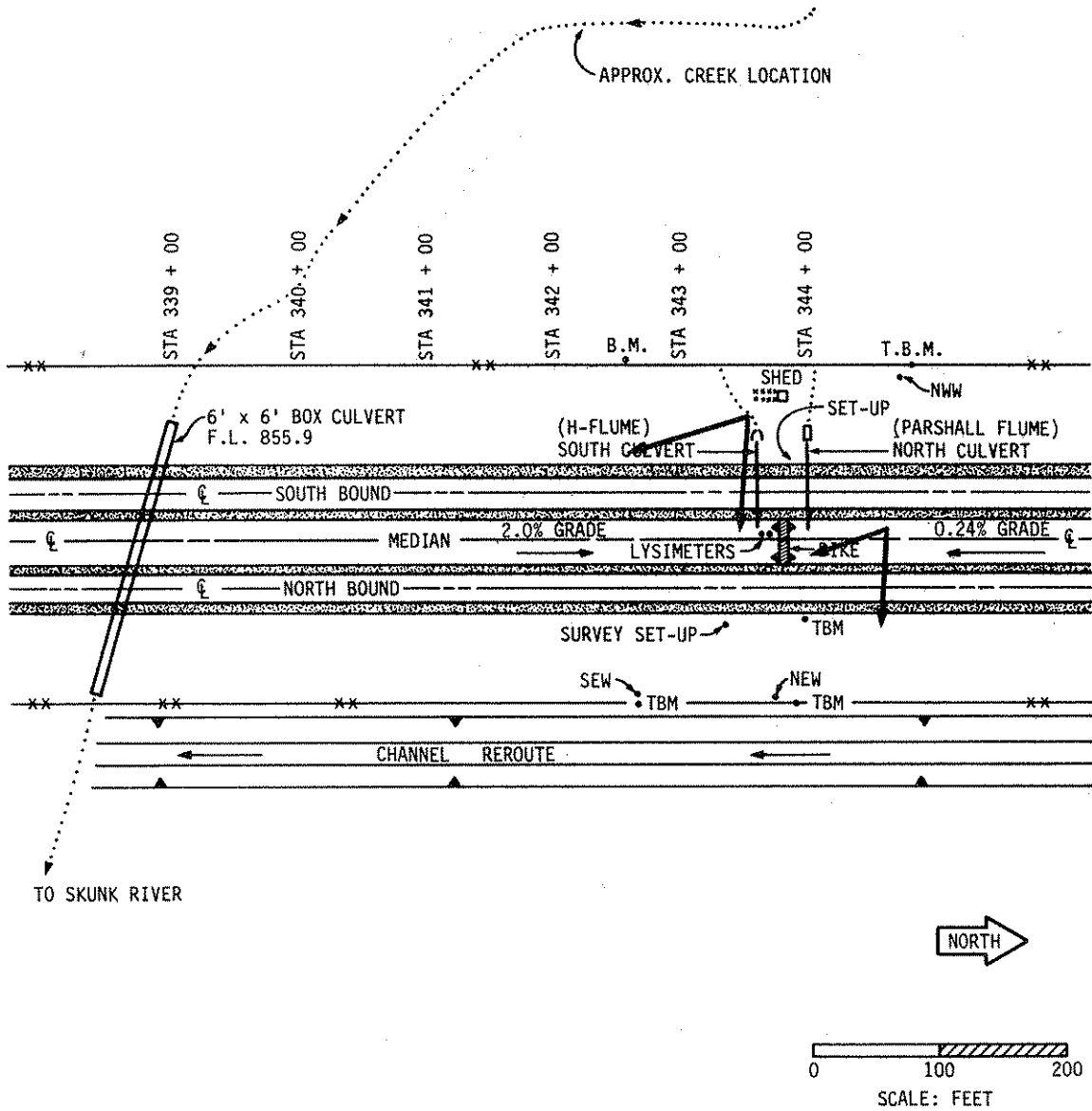

Fig. 9. Direction of groundwater flow Iowa DOT highway runoff study. (Range of observations shown as arrows).

After installation by the contractor, the wells were pumped at an approximate rate of five gallons per minute for approximately one half hour (until clear). Prior to sampling, but in no case more than 15 hours prior, the wells were developed by bailing. Approximately 20 gallons to 25 gallons were removed from each well during each presampling development period.

During development, water from wells NEW and SEW were observed to have substantial amounts of red (presumed iron) precipitate. The precipitate was noticeable for the first 5 to 10 bailer volumes (5 liters to 10 liters). Following development by bailing, however, the water was observed to be relatively clear and any suspended solids were gray in color.

Samples were obtained from the ground water wells on two occasions, December 19, 1983, and April 12, 1984. The chemical analyses of the samples are presented in Tables 4 and 5, respectively. The water is a hard (contains high concentrations of calcium and magnesium) bicarbonate-type water.

Because only two samples have been analyzed at each well, it is too early to make conclusive statements about the potential impacts of highway activities on the groundwater at the site. Based on the observed data, it is probable that highway activities are affecting chloride, lead, iron, and oil and grease concentrations.

It is possible that despite steam cleaning and substantial bailing and pumping, the stainless steel pipe used in construction of the wells may account for the oil and grease observations.

ENGINEERING RESEARCH INSTITUTE
 ANALYTICAL SERVICES LABORATORY
 REPORT OF CHEMICAL ANALYSIS

TO: HARVEY GULLICKS
 PROJECT: DOT 1219
 DATE: DECEMBER 21, 1983
 BY: *James A. Gault*

Table 4. Report of chemical analysis 12/21/83.

DOT 1219	NEW	NWW	SEW FIELD BLANK	UNITS	
CHLORIDE	4.2	24	2.9	.8	MG/L*
COND	1090	935	960	3	UMHO/CM**
COD	40.9	42.4	36.1	<10	MG/L
TOC	17	15	14	2.3	MG/L
OIL & GR	<0.1	14	35.0	.3	MG/L
TOT CU	44.4	28	49.3	2.7	UG/L***
SOL CU	3.1	4.1	3.4	****	UG/L
TOT FE	52.1	13.4	49.3	<0.02	MG/L
SOL FE	10.2	.10	5.12	****	MG/L
TOT PB	52	32	59	<4	UG/L
SOL PB	26	16	19	****	UG/L
TOT ZN	145	93.3	131	<2	UG/L
SOL ZN	9.9	27	8.7	****	UG/L

* milligrams per liter

** micromhos per centimeter

*** micrograms per liter

ENGINEERING RESEARCH INSTITUTE
ANALYTICAL SERVICES LABORATORY
REPORT OF CHEMICAL ANALYSIS

TO: HARVEY GULLICKS³⁶
PROJECT: DOT 0412
DATE: APRIL 30, 1984
BY: *J. J. [Signature]*

Table 5. Report of chemical analysis 4/30/84.

DOT 0412	NEW	NWW	SEW	UNITS
CHLORIDE	28.5	15.7	6.8	MG/L*
SPEC COND	900	430	780	UMHO/CM**
COD	11.2	7.3	18.6	MG/L
TOC	6	6	8	MG/L
OIL & GREASE	3.0	1.9	<1.8	MG/L
TOT CU	2.9	3.3	3.5	UG/L***
SOL CU	<0.4	<0.4	4.6	UG/L
TOT FE	9.24	.095	.52/.63	MG/L
SOL FE	8.65	.013	1.87(CONTAM)	MG/L
TOT PB	21	<9	15	UG/L
SOL PB	17	<9	18	UG/L
TOT ZN	7	5	6	UG/L
SOL ZN	15	8	9	UG/L
SULFATE	****	19.0	****	MG/L
PHENOL-ALK	****	0	****	MG/L AS CaCO3
TOTAL ALK	****	160	****	MG/L AS CaCO3
SOL CA	****	57.1	****	MG/L
SOL MG	****	16.1	****	MG/L
SOL NA	****	12.6	****	MG/L
SOL K	****	.61	****	MG/L

NO₃ + NO₂ - N 0.31 mg/L
as N

* milligrams per liter; ** micromhos per centimeter; *** micrograms per liter

The high levels of iron in the down gradient wells, SEW and NEW, have only two possible sources. Either they are the direct result of up gradient highway activities or they are the result of localized iron precipitation in the soil interstices bordering the channel reroute. The latter mechanism is also highway related since portions of over 2700 feet of I-35 drain directly into the channel reroute. The runoff has already been demonstrated to be high in iron. A patented in situ iron and manganese removal process makes use of the mechanisms of iron and manganese filtration of oxidized floc by periodic injection of aerated, degassed water into soils located peripherally around a groundwater supply well (reference Civil Engineering, March 1984, page 18). It is possible that the channel reroute has over its existence provided enough diffusion of aerated water during periods of temporary groundwater gradient reversals to the zone along its banks to develop a zone of iron filter cake on which iron precipitate continually deposits itself. In order for this mechanism to affect the monitoring wells, the zone must be of considerable lateral extent, on the order of 25 feet or more. This mechanism is less plausible than the first.

The lysimeters installed in the median were sampled on July 20, 1984, by ISU and DOT personnel. The samples were analyzed and the data is included in Table A3 in the Appendix. The data clearly shows downward migration of high levels of chloride, lead, and iron to a depth of at least 10 feet below ground level. The contaminants definitely reach the groundwater table in concentrations greater than background levels.

5. SUMMARY

The highway runoff project results to date indicate that highway activities do contribute significant amounts of chloride, oil and grease, metals, and oxygen demand to runoff waters and groundwater. The runoff volume from the flat (0.24 percent) median frequently exceeds that of the steep (2 percent) median when soil conditions are not saturated. However, the peak flows for the flat area are generally 52 percent to 69 percent of the steep area peak flows for most storm events. The flat area peak flow to steep area peak flow ratio approached 0.9 for the June 13, 1984, precipitation event with an approximate intensity of 1.0 inch per hour for a two-hour duration.

When saturated soil conditions exist, the total runoff nearly equalled and in some cases slightly exceeded total precipitation for medium to heavy precipitation events. This is because of both lateral precipitation variation and highway traffic effects. For unsaturated soil conditions, the runoff was generally 50 percent to 70 percent of the precipitation.

Basin lag times were observed to be highly dependent on the basin slope, the degree of soil saturation, and on rainfall intensity. However, for the worst observed conditions, i.e., saturated soils and 1.0 inch per hour to 1.6 inches per hour rainfall intensity, basin lag times for both the flat and the steep slopes were observed to be on the order of 13 minutes to 35 minutes.

The reduction of highway runoff environmental impacts depends to a large extent on suspended solids reduction. Recommendations are

contained in the report text regarding methods for suspended solids control. Chloride, another contaminant in highway runoff, is highly soluble and not strongly adsorbed in soil matrices. Therefore, the control of chloride reverts to stringent application control. It is probable that some of the suspended solids control recommendations would redistribute the final impacts of soluble contaminants. The recommendations would increase basin lag times for most storm events and encourage infiltration over larger land surfaces. Thus, runoff volumes to streams would be reduced, infiltration in small isolated ponding areas would be reduced, and the soil bulk available for adsorption of contaminants would be maximized.

6. APPENDIX

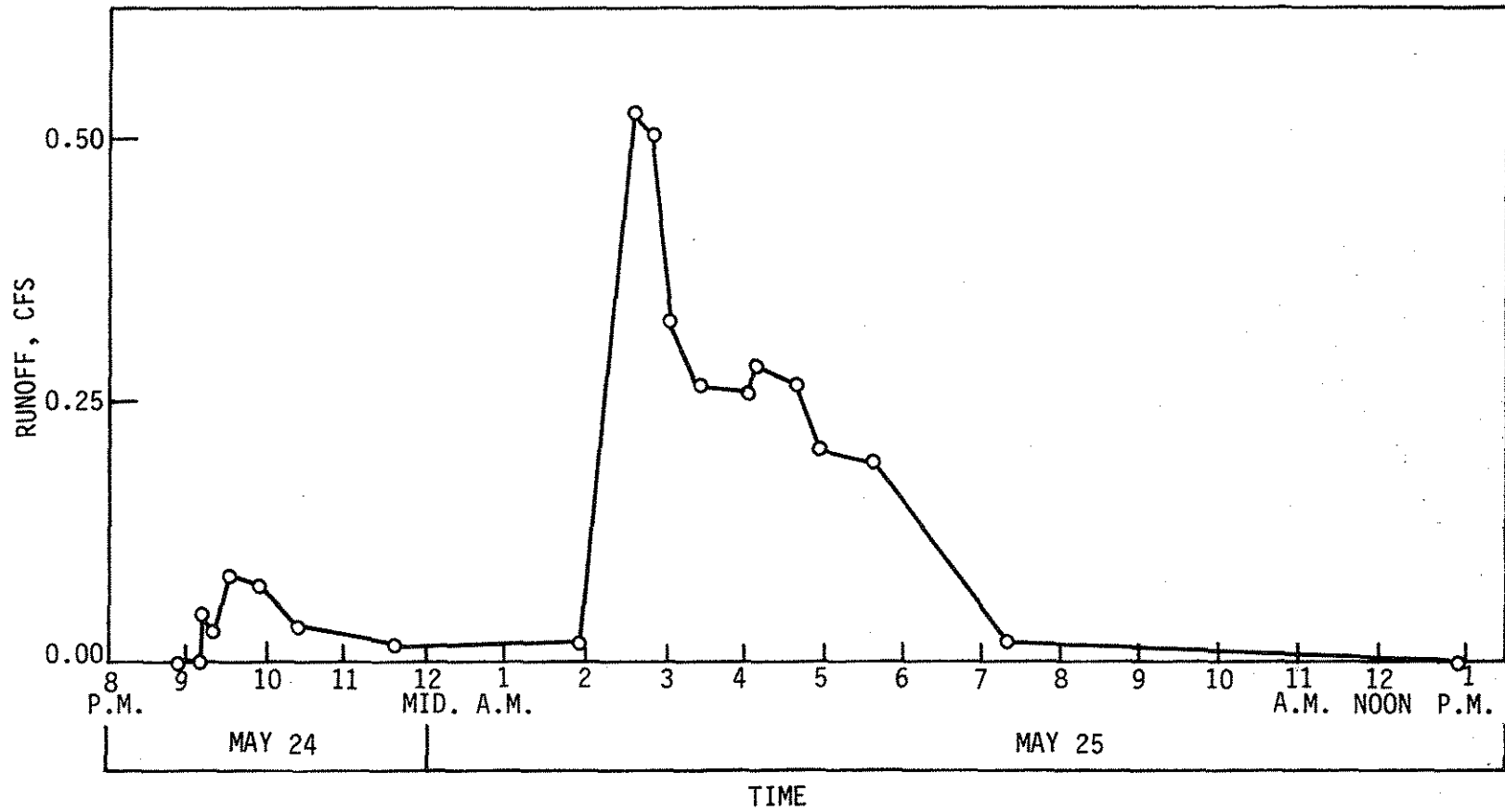

Fig. A1. H-flume hydrograph 5/24/84 and 5/25/84 events.

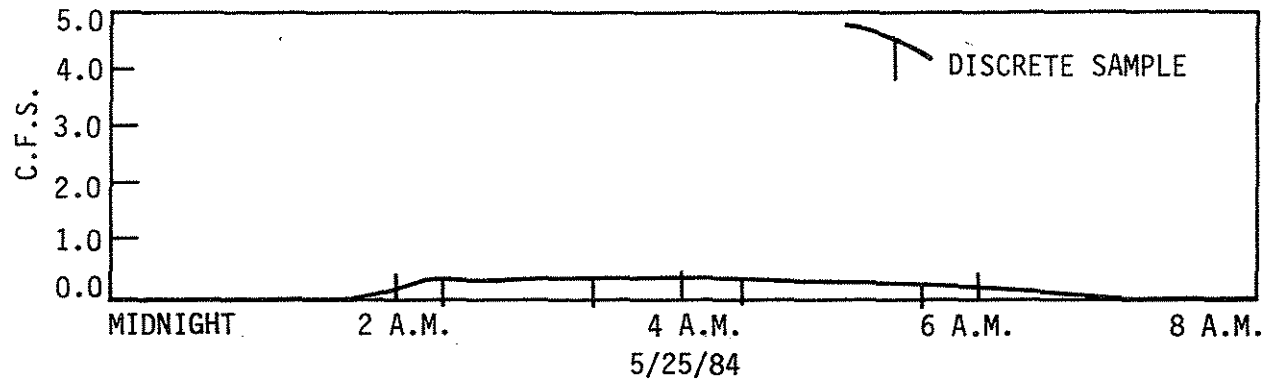

Fig. A2. Parshall flume hydrograph 5/24/84 and 5/25/84 event.

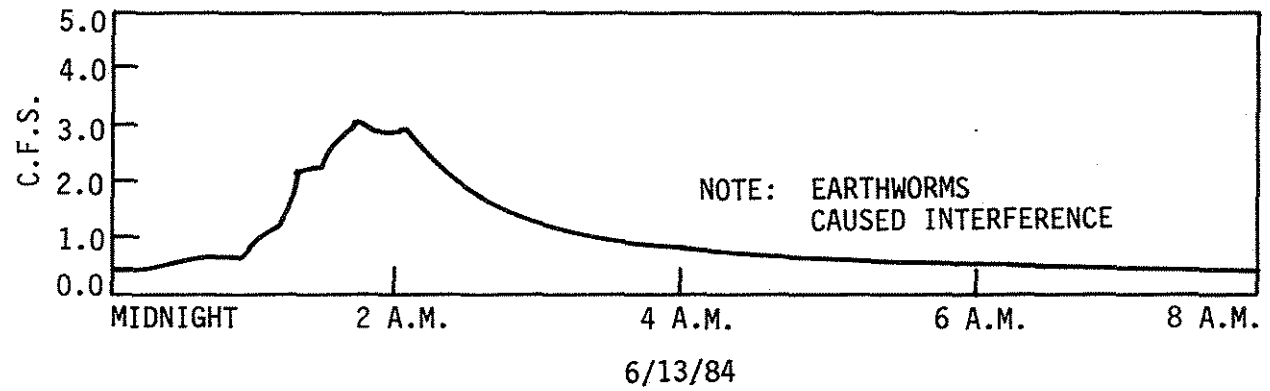

Fig. A3. Parshall flume hydrograph 6/13/84 events.

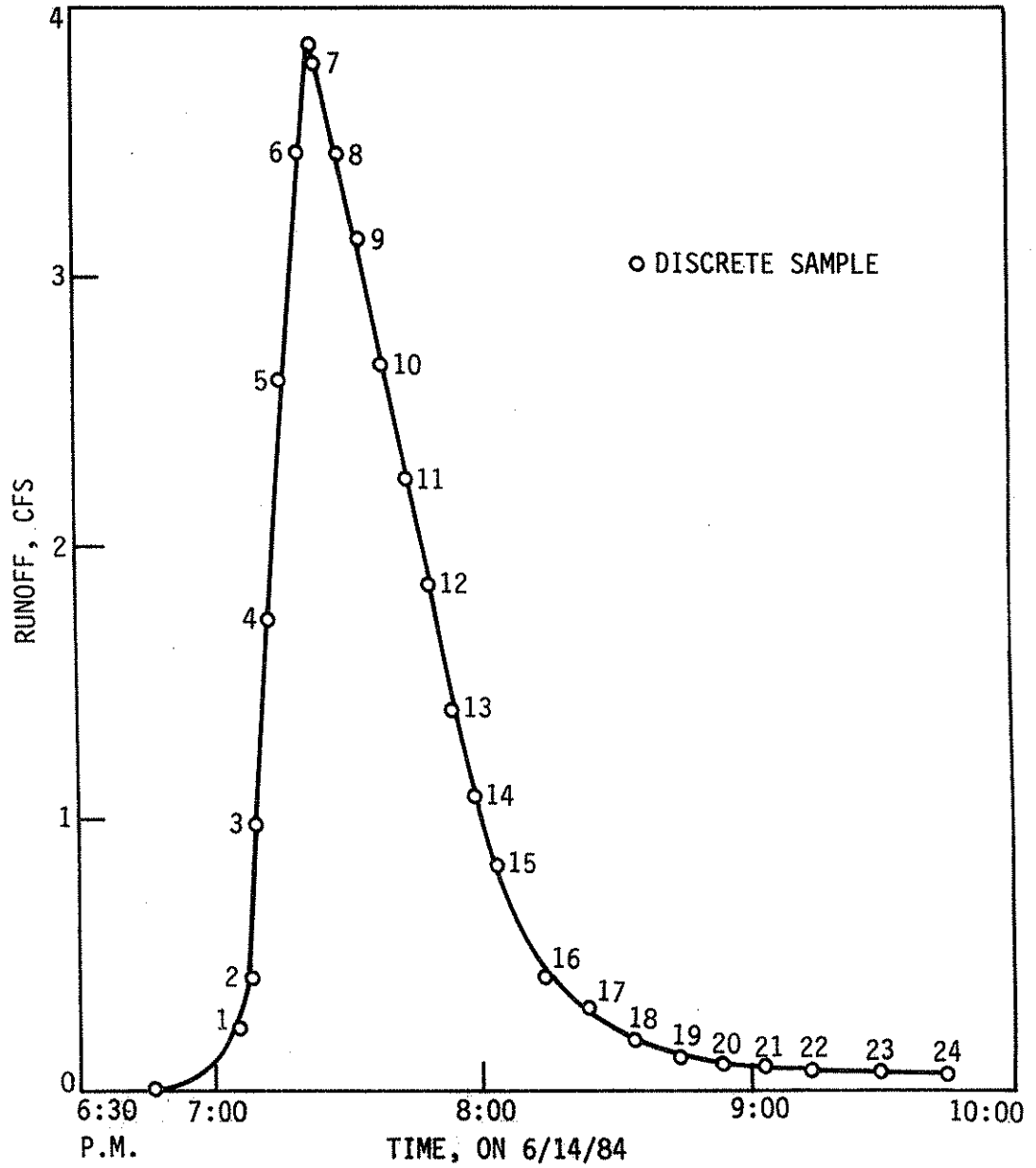

Fig. A4. H-flume hydrograph 6/14/84 event.

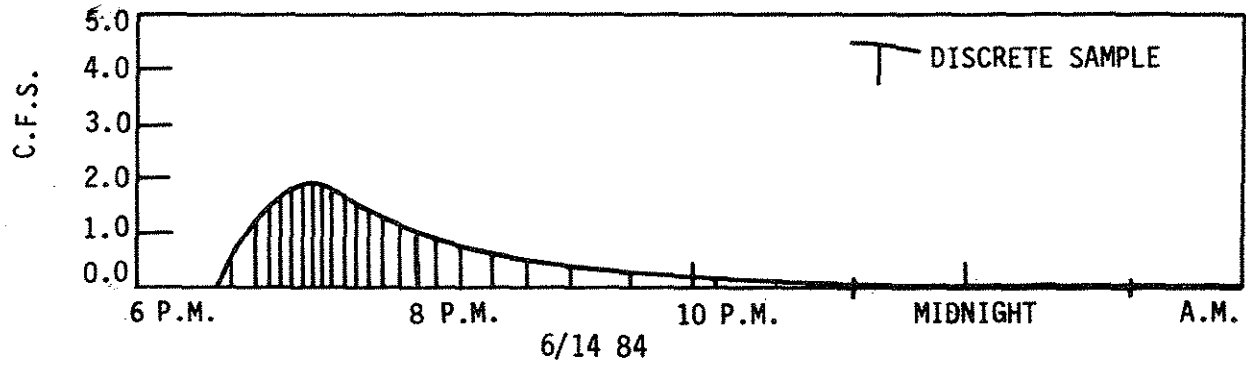

Fig. A5. Parshall flume hydrograph 6/14/84 event.

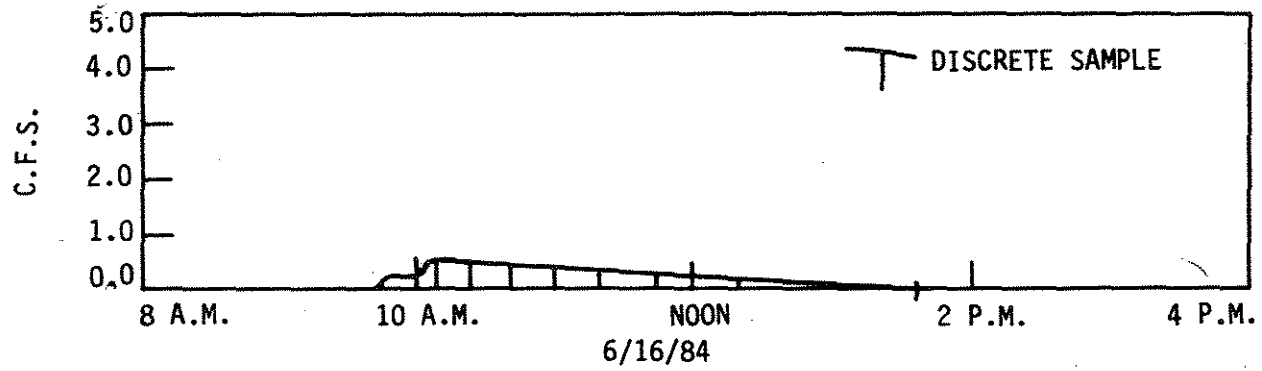

Fig. A6. Parshall flume hydrograph 6/16/84 event.

ENGINEERING RESEARCH INSTITUTE

ANALYTICAL SERVICES LABORATORY

REPORT OF CHEMICAL ANALYSIS

45

TO: HARVEY GULLICKS

PROJECT: DOT 0618

DATE: JUNE 25, 1984

BY: 

Table A1. Report of chemical analysis 6/25/84.

DOT 0618	PARSHALL	R FLUME	UNITS
PH	7.35	7.52	-LOG H+
COND	68	93	UMHO/CM*
TS	122	184	MG/L**
SS	40.9	111	MG/L
CL	<2	<2	MG/L
NO3+NO2N	.22	.19	MG/L N
TKN	.52	.65	MG/L N
TOT P	.12	.17	MG/L P
COD	21.9	24.8	MG/L
TOC	11	12	MG/L
OIL&GR	2.4	<2	MG/L
F. COLI	400	900	ORG./LL
F. STREP	9800	2700	ORG./LL
TOT CU	6.2	9.6	UG/L***
TOT FE	1.28	4.59	MG/L
TOT PB	14	23	UG/L
TOT ZN	13	27	UG/L

SAMPLES WERE COLLECTED ON 6/15, BUT WERE NOT AVAILABLE FOR ANALYSIS UNTIL 6/18. THIS IS EXCESSIVE HOLDING TIME FOR PH AND BACTERIA.

* micromhos per centimeter; ** milligrams per liter; *** micrograms per liter

Table A2. Summary of hydraulic data for runoff events.

Date	Flume (Terrain)	Rainfall Intensity Inches/Hour	Basin Lag Time Minutes*	Peak Flow cfs	Total Event Precip. Inches	Total Event Runoff ft ³	Runoff Inches/Acre
4/21/84	H (steep)	0.07 (9.4 hrs)	456	0.103	0.70	~2,700	0.40
	Parshall (flat)	0.07 (9.4 hrs)	264	0.16	0.70	~3,500	0.57
4/29/84 and 4/30/84	H (steep)	Overall 0.43 (3.35 hrs)			2.15 (1.60)**	~8,500 (~8,200)**	1.25 (1.21)**
		1) 0.6 (0.58 hrs)	40	0.57			
		2) 0.47 (2.10 hrs)	49	1.37			
		3) 0.28 (0.83 hrs)	38	0.26			
	Parshall (flat)	Overall 0.43 (3.35 hrs)	74	0.95	2.15 (1.60)**	~11,000 (~9,800)**	1.80 (1.59)**
5/24/84 and 5/25/84	H (steep)	1) 1.6 (~9 minutes)	73	0.085	1.33 {	435	0.07
		2) 0.45 (39 min)	51	0.526		0.92	4,632
	Parshall (flat)	Overall 0.10 (9 hrs)	110	0.32	1.33	~5,300	0.86
5/27/84 and 5/28/84		Avg. 0.21 (7.13 hrs) Max ≅ 0.4 to 0.5 inches/hr for brief periods			1.87	Not Available	Not Available
6/7/84	H (steep)	1.5 (Brief period) ~12 minutes	Not Available	0.28	0.36	Not Available	Not Available
	Parshall (flat)	1.5 (Brief period)	20	0.18	0.36	1,440	0.23
6/9/84	H (steep)	0.1 (3.87 hrs)	Not Available	Not Available	0.72	Not Available	Not Available
	Parshall (flat)	0.1 (3.87 hrs)	Not Available	Not Available	0.72	Not Available	Not Available
6/13/84	H (steep)	Avg. 0.98 (2.12 hrs) Duration	Not Available	2.79	2.49	Not Available	Not Available
	Parshall (flat)	Max. 1.53 (1.57 hrs) 0.98 (2.12 hrs)	13 to 18***	2.60	2.49	~16,200***	2.63***
6/14/84	H (steep)	1.67 (1.01 hr)	39	3.87	1.83	~12,500	1.84
	Parshall (flat)	1.67 (1.01 hr)	32	2.00	1.83	~11,735	1.90
6/16/84	H (steep)	1.80 (16 min)	Not Available	0.80 cfs	0.57	Not Available	
	Parshall (flat)	1.80 (16 min)	24	0.55 cfs	0.57	3,900	0.63
6/21/84	H (steep)	0.60 (25 min)	Not Available	Not Available	0.25	Not Available	Not Available
	Parshall (flat)	0.60 (25 min)	Not Available	<0.10 cfs	0.25	Not Available	Not Available

Note: Drainage areas are ~49 percent paved surface.
 TOTAL AREAS H-Flume (steep slope) ~ 1.87 acres
 Parshall flume ~ 1.70 acres

* ±5 minutes

** Related to precipitation between 1:45 p.m. and 5:12 p.m. on 4/29/84

*** Equipment malfunction because of earthworms; therefore this is the best estimate of flow. Rain gauge clock was fast and correction was substantial for this event.

ENGINEERING RESEARCH INSTITUTE
 ANALYTICAL SERVICES LABORATORY
 REPORT OF CHEMICAL ANALYSIS

TO: HARVEY GULLICKS
 PROJECT: DOT 0723
 DATE: JULY 30, 1984
 BY: *J. J. Savant*

Table A3. Report of chemical analysis 7/30/84.

DOT 0723	NORTH LYS	SOUTH LYS	DUSTFALL	UNITS
TOT CU	16	23	****	UG/L *
TOT FE	13	48	****	MG/L **
TOT PB	48	126	****	UG/L
TOT ZN	160	54	****	UG/L
CL	106	1230	****	MG/L
COND	1870	5300	****	UMHO/CM ***
TOC	****	54	****	MG/L
COD	****	131	****	MG/L
TOTAL SOLIDS	****	****	546	MG/L
VOLUME	****	****	2290	ML

* micrograms per liter

** milligrams per liter

*** micromhos per centimeter