

# Demonstration of Load Rating Capabilities through Physical Load Testing: Johnson County Bridge Case Study



**Final Report 3 of 3**  
**August 2013**



**IOWA STATE UNIVERSITY**  
**Institute for Transportation**

**Sponsored by**  
Soy Transportation Coalition  
Federal Highway Administration  
Iowa Department of Transportation  
(Part of InTrans Project 12-444)

## **About the BEC**

The mission of the Bridge Engineering Center is to conduct research on bridge technologies to help bridge designers/owners design, build, and maintain long-lasting bridges.

## **Disclaimer Notice**

The contents of this report reflect the views of the authors, who are responsible for the facts and the accuracy of the information presented herein. The opinions, findings and conclusions expressed in this publication are those of the authors and not necessarily those of the sponsors.

The sponsors assume no liability for the contents or use of the information contained in this document. This report does not constitute a standard, specification, or regulation.

The sponsors do not endorse products or manufacturers. Trademarks or manufacturers' names appear in this report only because they are considered essential to the objective of the document.

## **Non-Discrimination Statement**

Iowa State University does not discriminate on the basis of race, color, age, religion, national origin, sexual orientation, gender identity, genetic information, sex, marital status, disability, or status as a U.S. veteran. Inquiries can be directed to the Director of Equal Opportunity and Compliance, 3280 Beardshear Hall, (515) 294-7612.

## **Iowa Department of Transportation Statements**

Federal and state laws prohibit employment and/or public accommodation discrimination on the basis of age, color, creed, disability, gender identity, national origin, pregnancy, race, religion, sex, sexual orientation or veteran's status. If you believe you have been discriminated against, please contact the Iowa Civil Rights Commission at 800-457-4416 or Iowa Department of Transportation's affirmative action officer. If you need accommodations because of a disability to access the Iowa Department of Transportation's services, contact the agency's affirmative action officer at 800-262-0003.

The preparation of this report was financed in part through funds provided by the Iowa Department of Transportation through its "Second Revised Agreement for the Management of Research Conducted by Iowa State University for the Iowa Department of Transportation" and its amendments.

The opinions, findings, and conclusions expressed in this publication are those of the authors and not necessarily those of the Iowa Department of Transportation or the U.S. Department of Transportation Federal Highway Administration.

**Technical Report Documentation Page**

<b>1. Report No.</b> Part of InTrans Project 12-444		<b>2. Government Accession No.</b>		<b>3. Recipient's Catalog No.</b>	
<b>4. Title and Subtitle</b> Demonstration of Load Rating Capabilities through Physical Load Testing: Johnson County Bridge Case Study				<b>5. Report Date</b> August 2013	
				<b>6. Performing Organization Code</b>	
<b>7. Author(s)</b> Travis Hosteng and Brent Phares				<b>8. Performing Organization Report No.</b> Part of InTrans Project 11-411	
<b>9. Performing Organization Name and Address</b> Bridge Engineering Center Iowa State University 2711 South Loop Drive, Suite 4700 Ames, IA 50010-8664				<b>10. Work Unit No. (TRAIS)</b>	
				<b>11. Contract or Grant No.</b>	
<b>12. Sponsoring Organization Name and Address</b> Iowa Department of Transportation, 800 Lincoln Way, Ames, IA 50010 Soy Transportation Coalition, 1255 SW Prairie Trail Parkway, Ankeny, IA 50023 Federal Highway Administration, U.S. Department of Transportation, 400 7th Street SW, Washington, DC 20590				<b>13. Type of Report and Period Covered</b> Final Report 3 of 3	
				<b>14. Sponsoring Agency Code</b> SPR RB32-013	
<b>15. Supplementary Notes</b> Visit <a href="http://www.intrans.iastate.edu">www.intrans.iastate.edu</a> for color pdfs of this and other research reports.					
<b>16. Abstract</b> The objective of this work, Pilot Project - Demonstration of Capabilities and Benefits of Bridge Load Rating through Physical Testing, was to demonstrate the capabilities for load testing and rating bridges in Iowa, study the economic benefit of performing such testing, and perform outreach to local, state, and national engineers on the topic of bridge load testing and rating.  This report documents one of three bridges inspected, load tested, and load rated as part of the project, the Johnson County Bridge (FHWA #205750), including testing procedures and performance of the bridge under static loading along with the calculated load rating from the field-calibrated analytical model. Two parallel reports document the testing and load rating of the Sioux County Bridge (FHWA #308730) and the Ida County Bridge (FHWA #186070). A tech brief provides overall information about the project.					
<b>17. Key Words</b> agricultural traffic routes—bridge capacities—bridge loads—bridge rating—load restrictions—load testing—superloads				<b>18. Distribution Statement</b> No restrictions.	
<b>19. Security Classification (of this report)</b> Unclassified.		<b>20. Security Classification (of this page)</b> Unclassified.		<b>21. No. of Pages</b> 27	<b>22. Price</b> NA



# **DEMONSTRATION OF LOAD RATING CAPABILITIES THROUGH PHYSICAL LOAD TESTING: JOHNSON COUNTY BRIDGE CASE STUDY**

**Final Report 3 of 3  
August 2013**

## **Principal Investigators**

Brent Phares, Director  
Bridge Engineering Center, Iowa State University

Travis Hosteng, Bridge Research Specialist  
Bridge Engineering Center, Iowa State University

## **Authors**

Travis Hosteng and Brent Phares

## **Sponsored by**

Iowa Department of Transportation,  
Soy Transportation Coalition,  
Federal Highway Administration  
State Planning and Research Funding  
(SPR RB32-013)

Preparation of this report was financed in part  
through funds provided by the Iowa Department of Transportation  
through its Research Management Agreement with the  
Institute for Transportation  
(InTrans Project 12-444)

A report from

## **Institute for Transportation**

### **Iowa State University**

2711 South Loop Drive, Suite 4700

Ames, IA 50010-8664

Phone: 515-294-8103

Fax: 515-294-0467

[www.intrans.iastate.edu](http://www.intrans.iastate.edu)



## TABLE OF CONTENTS

ACKNOWLEDGMENTS .....	vii
INTRODUCTION .....	9
OBJECTIVE AND SCOPE .....	9
BRIDGE DESCRIPTION.....	9
FIELD TESTING.....	14
Methodology.....	14
Instrumentation .....	15
Static Loading .....	16
LOAD TEST RESULTS.....	18
LOAD RATING .....	21
Model Calibration .....	21
Calibration Results.....	22
Rating Factors .....	24
SUMMARY AND CONCLUSIONS .....	26
REFERENCES .....	27

## LIST OF FIGURES

Figure 1. Two-lane Johnson County Bridge FHWA #205750 .....	10
Figure 2. Johnson County Bridge end view .....	10
Figure 3. Johnson County Bridge elevation view .....	11
Figure 4. Johnson County Bridge load posting.....	11
Figure 5. Johnson County Bridge bearing .....	12
Figure 6. Johnson County Bridge plan view.....	13
Figure 7. Johnson County Bridge profile view .....	13
Figure 8. Johnson County Bridge strain transducer.....	14
Figure 9. Johnson County Bridge plan view of strain transducer locations .....	15
Figure 10. Johnson County Bridge cross-section view of strain transducer locations at midspan .....	16
Figure 11. Johnson County Bridge instrumentation setup.....	16
Figure 12. Johnson County Bridge test truck.....	17
Figure 13. Johnson County Bridge truck configuration and axle loads.....	17
Figure 14. Transverse load position for Johnson County Bridge testing.....	18
Figure 15. Data reproducibility for Johnson County Bridge test.....	19
Figure 16. Johnson County Bridge midspan strain distribution for one lane loaded cases .....	20
Figure 17. Johnson County Bridge midspan strain distribution for two lanes loaded cases .....	20
Figure 18. Finite element model of Johnson County Bridge with modeled test truck footprint ...	21
Figure 19. Johnson County Bridge midspan strain comparisons for LC3 Transducer 1881 .....	23
Figure 20. Johnson County Bridge midspan lateral distribution strain comparison for LC2 .....	23
Figure 21. AASHTO load rating vehicle configurations for Johnson County Bridge.....	24
Figure 22. Iowa load rating vehicle configurations for Johnson County Bridge .....	25

## LIST OF TABLES

Table 1. LFR rating factors applied .....	24
Table 2. Johnson County Bridge critical rating factors .....	26



## **ACKNOWLEDGMENTS**

The authors would like to acknowledge the Soy Transportation Coalition and the Iowa Department of Transportation (DOT) Office of Bridges and Structures for sponsoring this research using Federal Highway Administration (FHWA) state planning and research (SPR) funds. The authors would like to thank the technical advisory committee (TAC): Mark Dunn, Ahmad Abu-Hawash, Darla James, Nicole Fox, Mike Steenhoek, Craig Markley, Ping Lu, and Scott Neubauer. In addition, the authors would like to thank Justin Dahlberg, Tyler Muhlbauer, and Doug Wood at Iowa State University for their efforts during bridge testing. Finally, the research team would like to thank County personnel for their assistance with traffic control, use of load trucks, and other services.



## **INTRODUCTION**

The US is heavily dependent on its transportation system for the quick and efficient movement of people, goods, and military assets. While the bulk of traffic volume utilizes state routes, agricultural industries are dependent on both the state and local systems for their travel. With that said, the more than 4,000 load-restricted (i.e., posted) bridges on the secondary road system represent potential reductions in the efficiency of the movement of farm goods. This inefficiency has the potential to reduce the cost-competitiveness of the US agricultural industry.

Currently, the rating and potential posting of bridges is completed by bridge engineers who rely on theoretical analyses based on codified approaches. By no fault of their own, codified approaches must be widely applicable and, as a result, many assumptions must be made. Therefore, while the techniques provide a reliable means for assessing the safe load-carrying capacity, they are, by their very nature, sometimes conservative.

An alternative approach is to create an analytical model that represents the behavior of a specific bridge—as opposed to a code-specified, generic bridge—based on field test results from the bridge itself and subsequently perform the load ratings using the calibrated model.

Currently, the Iowa Department of Transportation (DOT) Office of Bridges and Structures identifies structures to be tested and is responsible for determining capacities and ratings based on the load test results. In addition to determining ratings, the Iowa DOT uses data from load tests to aid in permitting superloads and to resolve design questions. In addition, several counties across Iowa have utilized the same approaches to evaluate the need for load restrictions.

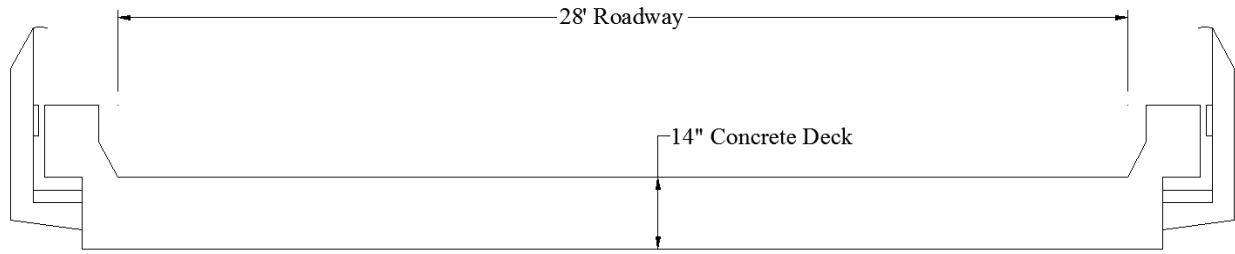
This report documents one of three bridges inspected, load tested, and load rated as part of the project, the Johnson County Bridge (FHWA #205750), including testing procedures and performance of the bridge under static loading along with the calculated load rating from the field-calibrated analytical model. Two parallel reports document the testing and load rating of the Sioux County Bridge (FHWA #308730) and the Ida County Bridge (FHWA #186070).

## **OBJECTIVE AND SCOPE**

The objective of this work was to demonstrate the capabilities for load testing and rating bridges in Iowa, study the economic benefit of performing such testing, and perform outreach to local, state, and national engineers on the topic of bridge load testing and rating.

## **BRIDGE DESCRIPTION**

The Johnson County Bridge (FHWA #205750) is a two-lane, single-span, reinforced concrete slab bridge located on Linn Benton Road approximately one mile south of Walford, Iowa (approximately 12 miles southwest of Cedar Rapids). The bridge was built in 1966 as a two-lane bridge with a 30 degree skew and a roadway width of 28 ft curb to curb as shown in Figure 1.



**Figure 1. Two-lane Johnson County Bridge FHWA #205750**

Figures 2 and 3 are end and elevation views, respectively, at the time of testing in 2013.



**Figure 2. Johnson County Bridge end view**



**Figure 3. Johnson County Bridge elevation view**

The current load posting for the bridge is shown in Figure 4.



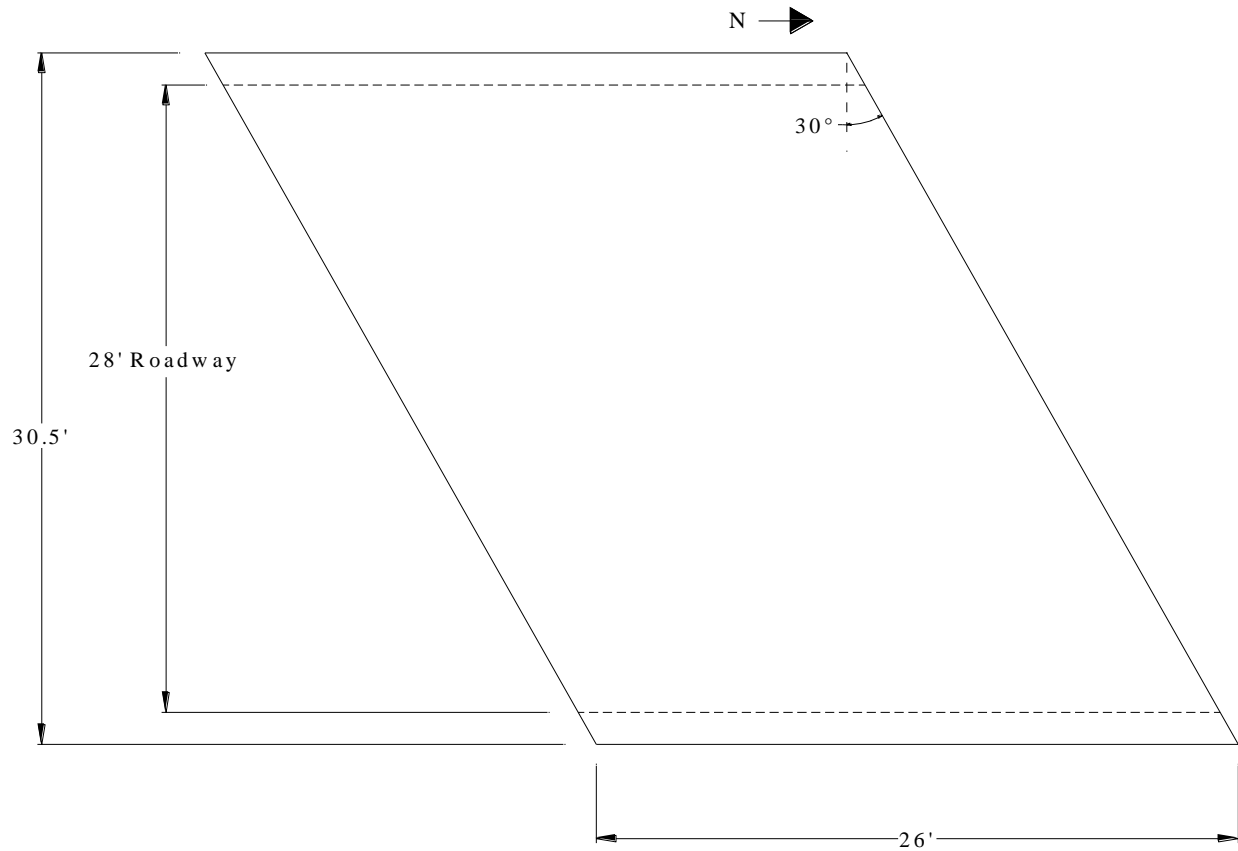
**Figure 4. Johnson County Bridge load posting**

The bridge substructure consists of concrete abutment caps and wing walls cast integral with the deck, supported by timber piles that are cast into the caps and wings, and timber backwalls as shown in Figure 5.

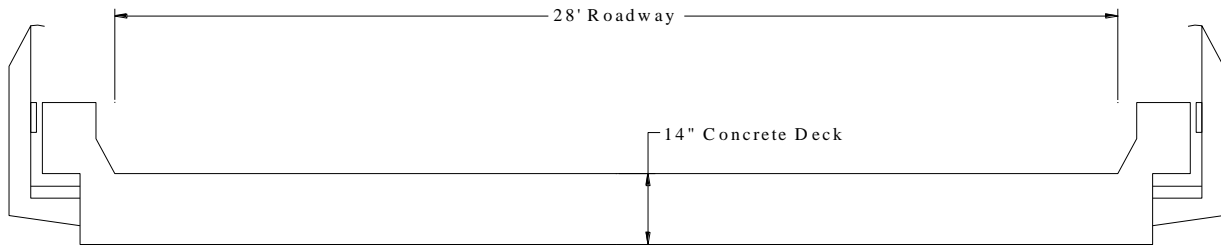


**Figure 5. Johnson County Bridge bearing**

As previously noted, the bridge superstructure is a single-span reinforced concrete slab bridge with a total length of 26 ft and a 30 degree skew from left to right. Figures 6 and 7 illustrate the bridge plan and profile views, respectively. The deck for the superstructure consists of an approximately 14 in. thick concrete slab with concrete curbs and steel beam/rail guardrail as illustrated in Figure 7.



**Figure 6. Johnson County Bridge plan view**



**Figure 7. Johnson County Bridge profile view**

## FIELD TESTING

### Methodology

The bridges selected for inclusion in this work were selected by the Iowa DOT Office of Bridges and Structures with the assistance of the BEC and the Soy Transportation Coalition, based on the criterion specified in the proposal. After bridge selection, preliminary information including as-built plans, photographs, inspection reports, and geometrical data were collected, if available, from the bridge owners (in this case, the Johnson County Engineer's Office). In addition, information related to any critical sections within the bridges was collected from the Iowa DOT Rating Engineer.

Once the basic bridge geometry information and photographs were obtained, an instrumentation scheme was developed such that all critical and necessary data could be collected during load testing. For the Johnson County Bridge, the instrumentation plan included the use of strain transducers at critical locations and seven transversely-spaced load cases. Strains were collected using Bridge Diagnostics, Inc. (BDI) strain transducers (with extensions) and the BDI Structural Testing System (STS).

Figure 8 illustrates a strain transducer with extension mounted on the bottom of the bridge deck. The total length of the gauge, including extension, was 15 in.; gauge lengths are adjustable in increments of 3 in. with the recommended length of the gauge for reinforced concrete slab structures being approximately equal to the depth of the slab.



**Figure 8. Johnson County Bridge strain transducer**

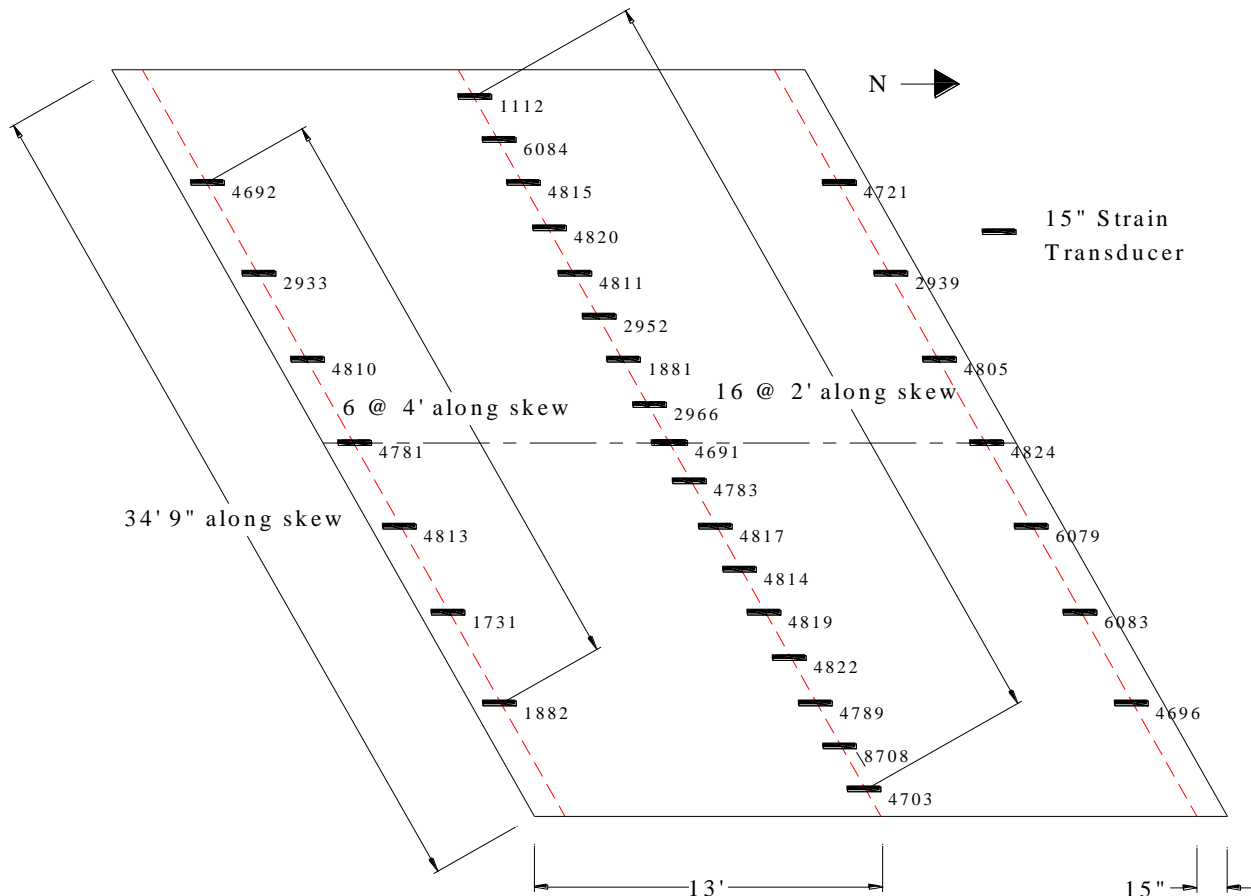


Load testing was then completed by monitoring the performance of the bridge as a controlled and known load crossed the bridge. The collected data were then evaluated and used in the creation and calibration of an analytical model. This calibrated model was then used for direct calculation of bridge rating factors using the rating and legal loads.

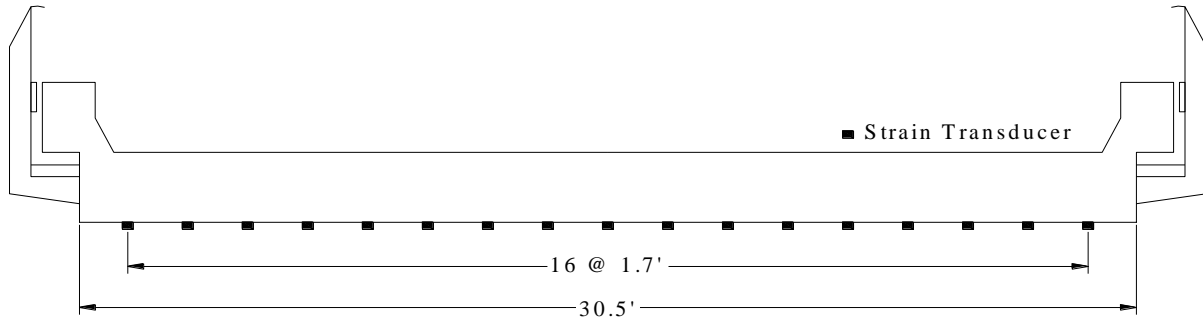
### Instrumentation

The instrumentation plan was developed based on the following: suggested critical sections as specified by the Office of Bridges and Structures (in this case, midspan of the approach span was determined to be the controlling section) and the information necessary to create and calibrate an accurate model of the bridge.

Based on these two criteria, strain transducers were installed on the bottom of the slab at the following cross-sections, as shown in Figures 9 and 10 in plan and cross-section views, respectively: both abutments and midspan of the instrumentation layout.



**Figure 9. Johnson County Bridge plan view of strain transducer locations**



**Figure 10. Johnson County Bridge cross-section view of strain transducer locations at midspan**

A total of 17 transducers were installed at midspan and were aligned along the skew at 2 ft intervals with the center transducer placed at the transverse centerline. Seven transducers were installed at each abutment, spaced evenly at 4 ft intervals with the center transducer placed at the transverse centerline. An image of a typical instrumentation installation is shown in Figure 11.



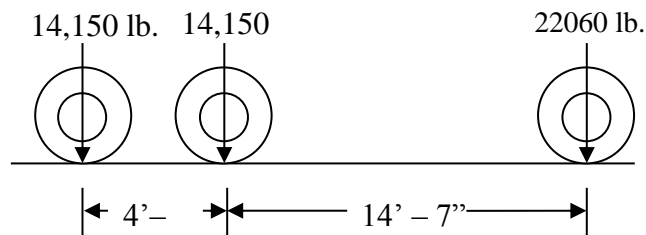
**Figure 11. Johnson County Bridge instrumentation setup**

### **Static Loading**

Loading of the structure was completed using a loaded and known tandem axle dump truck provided by Johnson County. The load truck is shown in Figure 12. Figure 13 shows the load truck dimensions and axle weights at the time of testing.



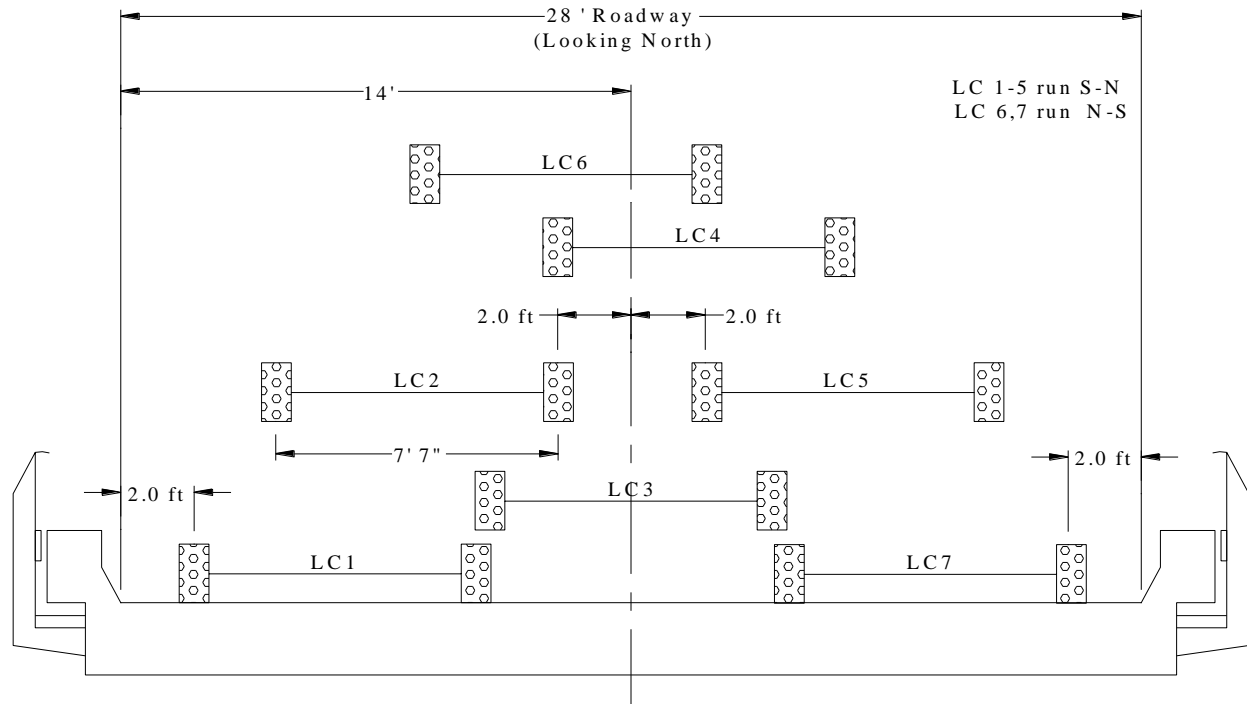
**Figure 12. Johnson County Bridge test truck**



**Figure 13. Johnson County Bridge truck configuration and axle loads**

The total weight of the truck was 50,360 lb., with front and rear axle weights of 22,060 lb., 14,150 lb., and 14,150 lb., respectively. The front and rear axle wheelbase were 7 ft and 6 ft, respectively; the rear axle spacing was 4 ft 5 in. center to center, and the distance from the forward most rear axle to the front axle was 14 ft 7 in.

Selection of truck position for the seven load cases was based on meeting the goals of this project and general bridge engineering concepts. The seven load cases are illustrated in Figure 14.



**Figure 14. Transverse load position for Johnson County Bridge testing**

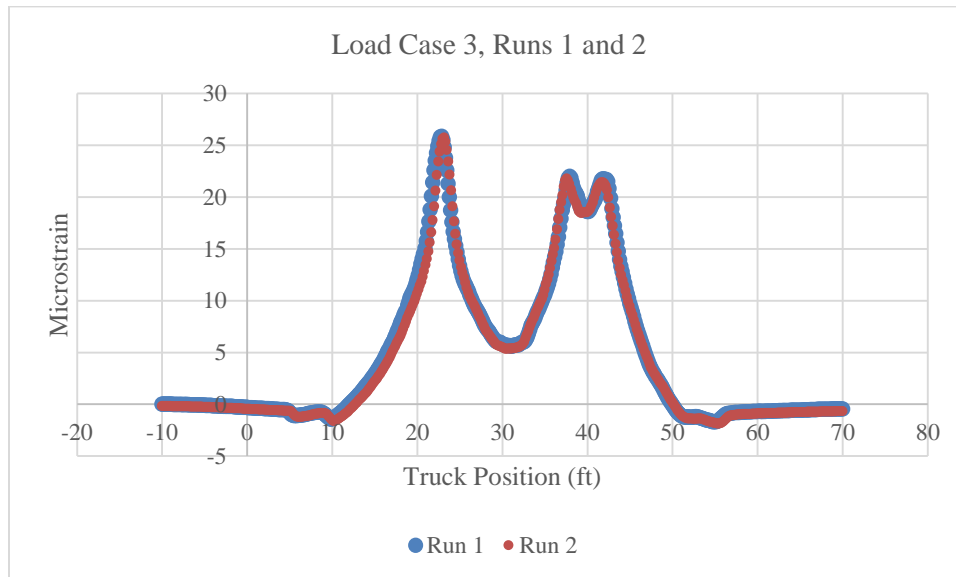
For the first load case, the truck was driven north at crawl speed with the centerline of the driver-side wheel line offset from the west curb by 2 ft. The second load case was located such that the centerline of the passenger-side wheel line was offset 2 ft west of the bridge centerline. The third load case consisted of the load truck driving north at crawl speed with the middle of the truck centered on the longitudinal centerline of the bridge. The fourth load case involved the load truck driving north with the centerline of the driver-side wheel line offset 2 ft west of the longitudinal centerline of the bridge. The fifth load case had the load truck driving north with the centerline of the driver-side wheel line offset 2 ft east of the bridge centerline. The load truck was driven south at crawl speed for the sixth and seventh load cases. The centerline of the driver-side wheel line was positioned 2 ft east of the bridge centerline for the sixth load case and with a 2 ft offset from the east curb for the seventh load case.

Crawl speed indicates the load truck was moving across the bridge at less than 5 mph. At this low speed, any dynamic effects that may be induced in the structure are negligible. The location of the truck was recorded using the front axle as a reference point by creating a data spike for every 10 ft traveled. This allowed the data to be presented and evaluated as a function of known truck position.

## LOAD TEST RESULTS

Following load testing, all field data were reviewed graphically to provide a qualitative assessment of the structure's live-load response. Some common assessments include strain history reproducibility for tests on common load paths, elastic strain response (strains return to zero after truck exits bridge), transverse load distribution, and axle signatures in strain data from gauges close to the load.

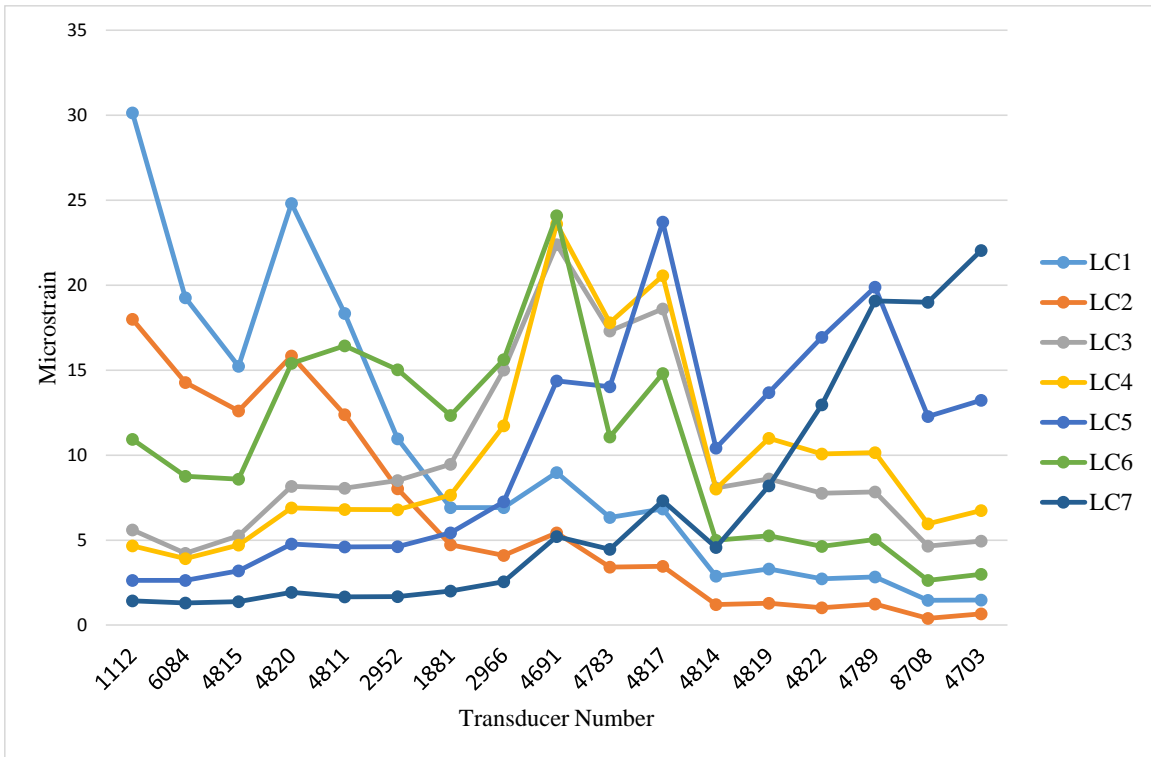
Figure 15 illustrates a strain history plot versus truck position for two tests of Load Case 3 on the bridge.



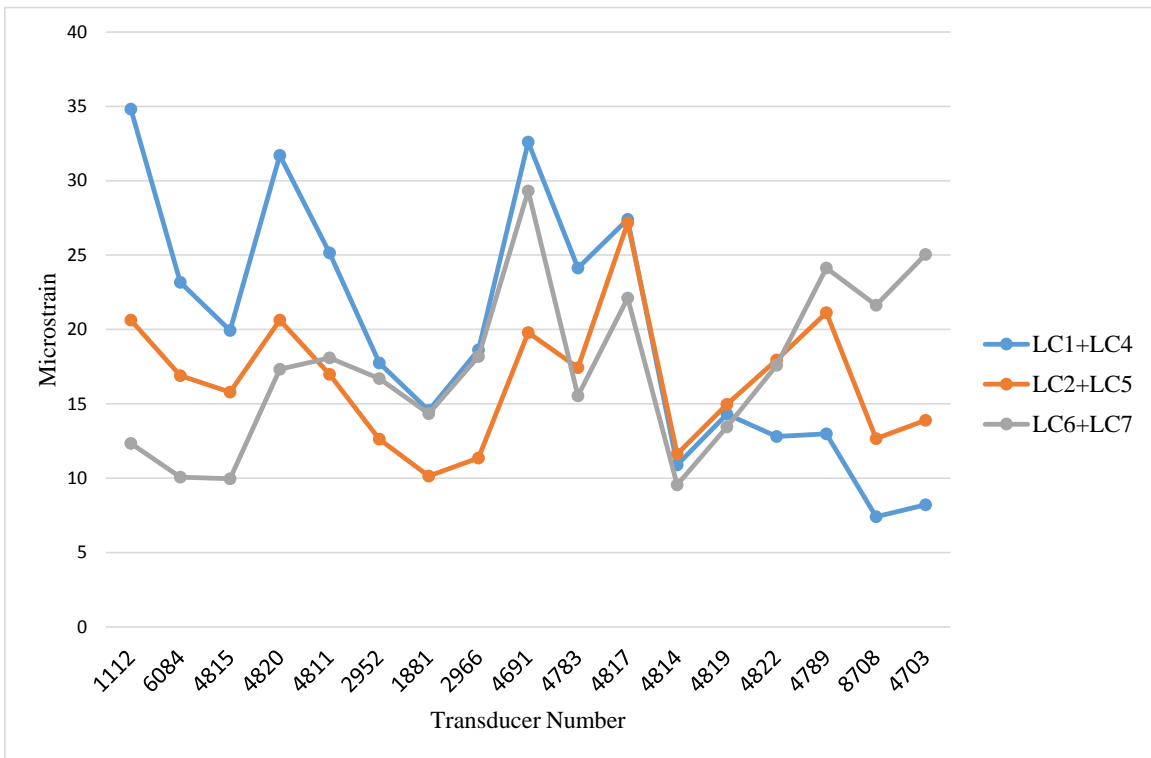
**Figure 15. Data reproducibility for Johnson County Bridge test**

Comparison of the two data sets in Figure 15 indicates good reproducibility in the data. Returns to approximately zero after passage of the load truck suggests elastic behavior in the response. All load cases had similar response histories with respect to the degree of reproducibility and elastic behavior; therefore, one data set from each load case was selected for further, more in-depth, evaluation.

Approximations of the transverse load distribution characteristics of the structure were obtained using the measured strains from the load tests. Figure 16 and 17 show the strain response from the entire midspan cross-section of gauges corresponding to the longitudinal load position producing the maximum midspan response for the one lane and two lane loaded cases, respectively. From Figures 16 and 17, it can be observed that the structure exhibited a reasonable level of lateral load distribution across the cross-section.



**Figure 16. Johnson County Bridge midspan strain distribution for one lane loaded cases**



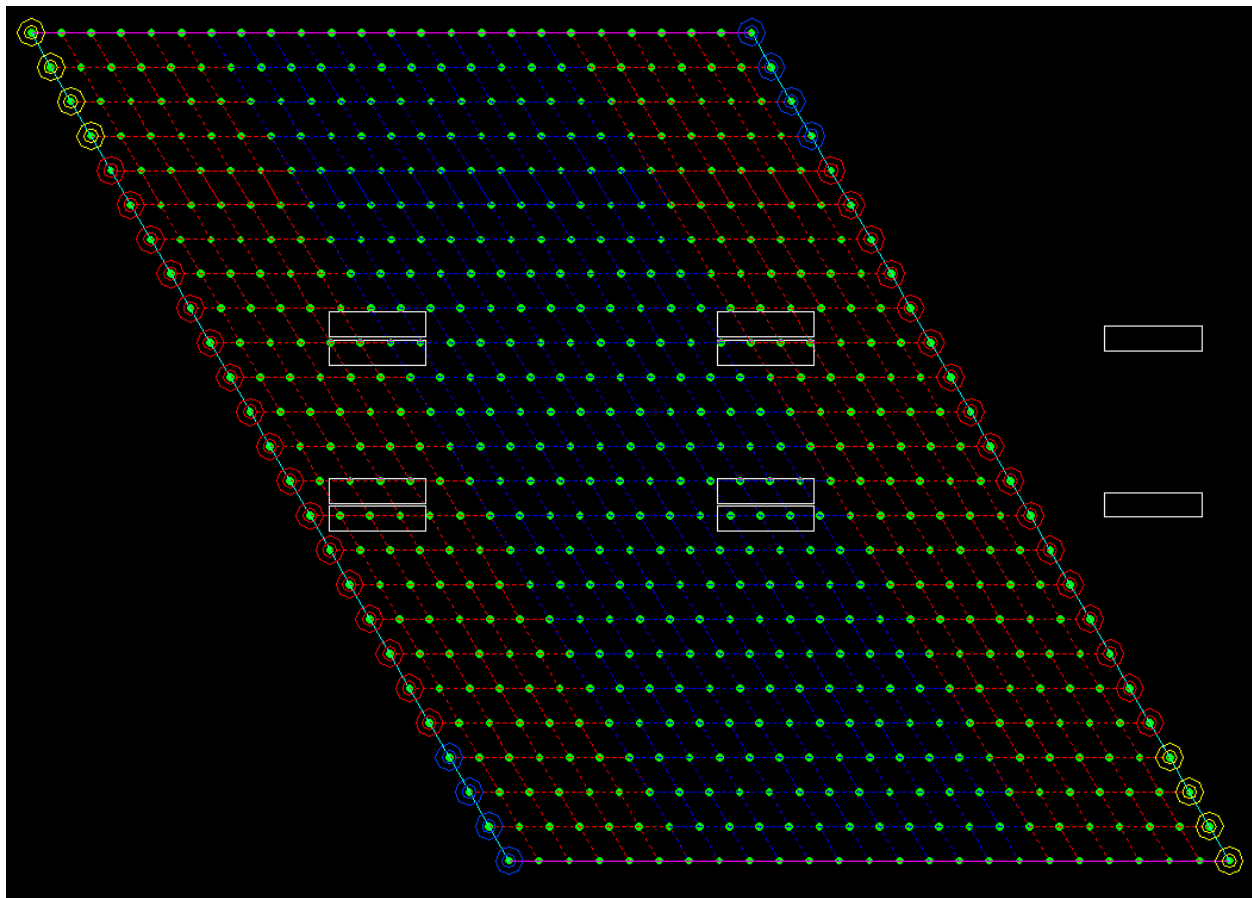
**Figure 17. Johnson County Bridge midspan strain distribution for two lanes loaded cases**

## LOAD RATING

This section briefly discusses the model calibration, validation procedures, and calculated rating factors for the Johnson County Bridge.

### Model Calibration

Information gathered from the bridge and the load test data evaluation was utilized to generate an initial two-dimensional, finite element model of the bridge using BDI's WinGEN modeling software as illustrated in Figure 18.



**Figure 18. Finite element model of Johnson County Bridge with modeled test truck footprint**

Overall bridge geometry, deck dimensions, approximate boundary (support restraint) conditions, along with material properties (modulus of elasticity, moment of inertia, etc.) were input for the basic model generation. Once the model was generated, a two-dimensional footprint and corresponding axle loads of the test truck, along with the load test data files, were input into the software.

With the initial model created, the load test procedures were reproduced analytically using BDI's WinSAC structural analysis and data correlation software. The software accomplishes this by moving the analytical truck footprint of the test truck across the model in consecutive load cases simulating the truck paths used during field testing. The analytical responses of this simulation were then compared (both statistically and graphically) to the field responses to validate the model's basic structure and to identify modeling deficiencies.

Model calibration continued until an acceptable level of correlation between the measured and analytical responses was achieved. This calibration involved an iterative process of optimizing material and stiffness properties (both cross-sectional and boundary conditions) until they were quantified realistically and the analytical model test results closely matched those from the field test results.

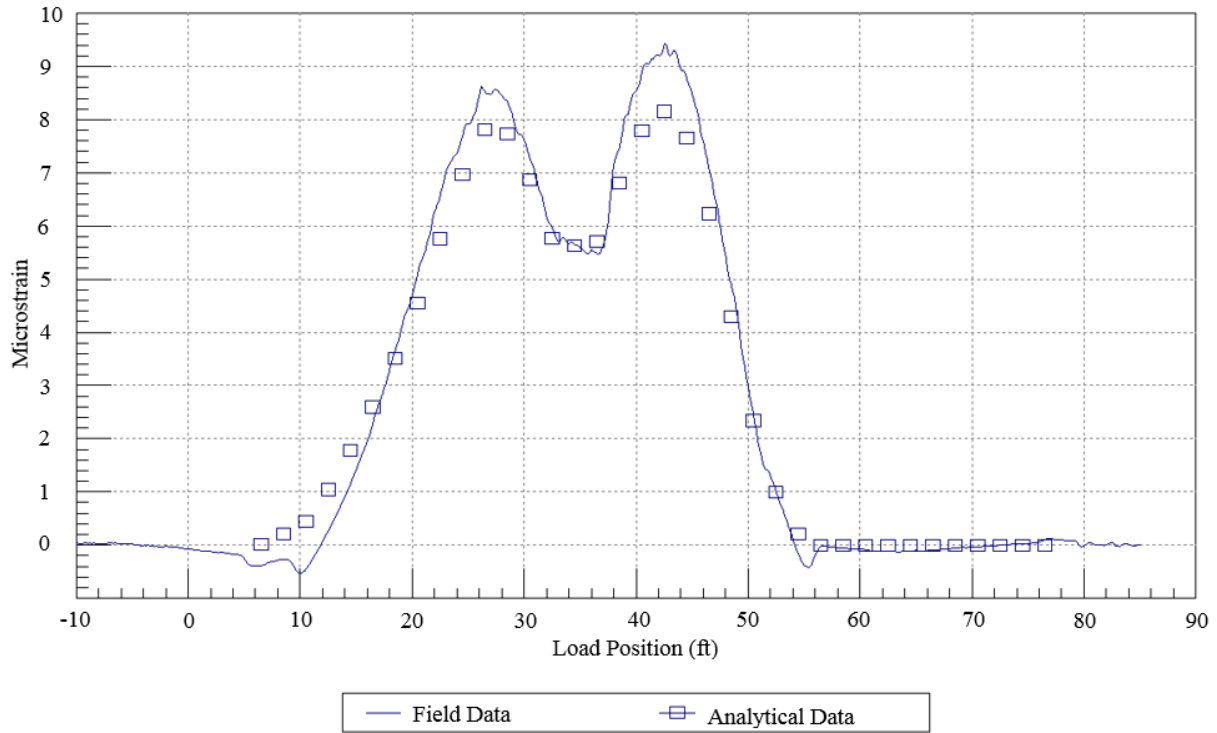
For bridges of this type and configuration, an acceptable level of correlation is on the order of 10 to 15 percent error. In the case of the Johnson County Bridge, the majority of the calibration effort was spent optimizing the approximate end restraint and stiffness characteristics observed in the test data.

### **Calibration Results**

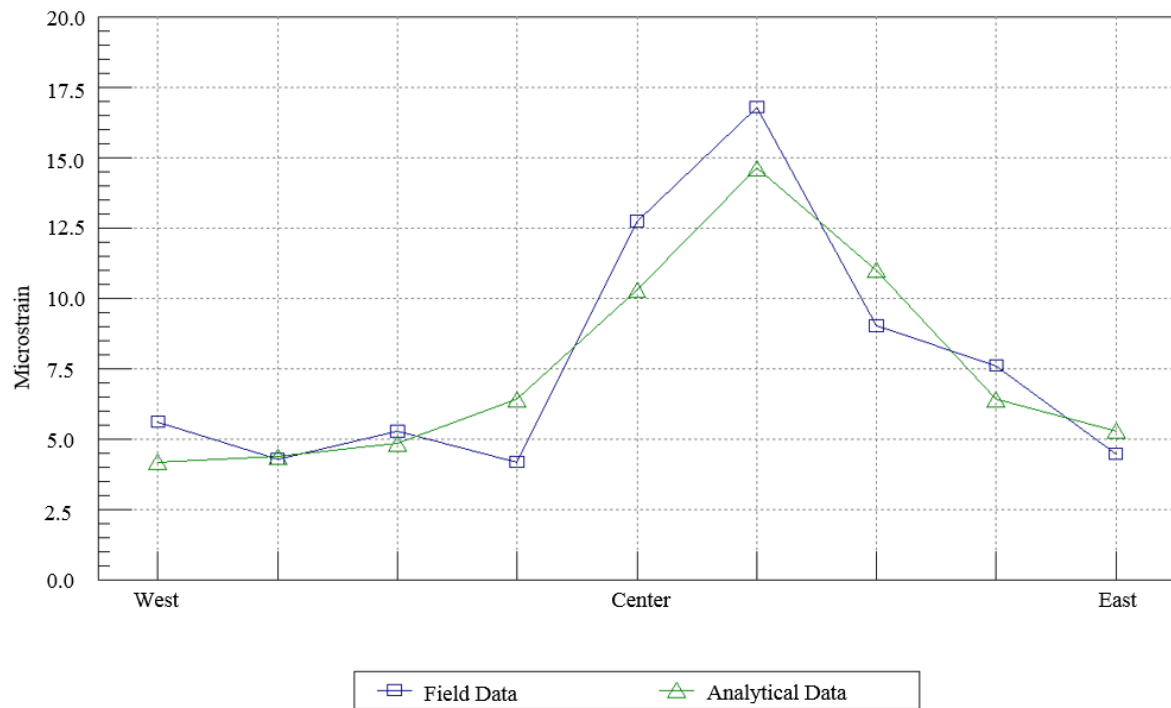
At the conclusion of the model calibration, the final model produced a 0.9433 correlation and approximately 11.0 percent error with the measured responses, which can be considered an excellent match for a concrete slab structure such as the Johnson County Bridge. The final model was found to closely match the member strains as shown in the comparison plots provided in Figure 19.

In addition, the model's midspan lateral distribution of strain closely matched that of the actual structure as shown in Figure 20.





**Figure 19. Johnson County Bridge midspan strain comparisons for LC3 Transducer 1881**



**Figure 20. Johnson County Bridge midspan lateral distribution strain comparison for LC2**

## Rating Factors

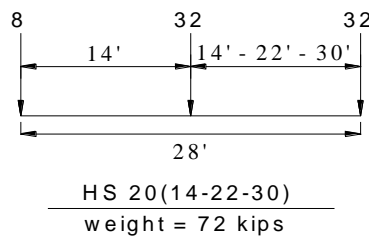
This section briefly discusses the methods and findings of the load rating procedures for the Johnson County Bridge. All appropriate bridge elements were load rated in accordance with the American Association of State Highway and Transportation Officials (AASHTO) load factor rating (LFR) guidelines shown in Table 1.

**Table 1. LFR rating factors applied**

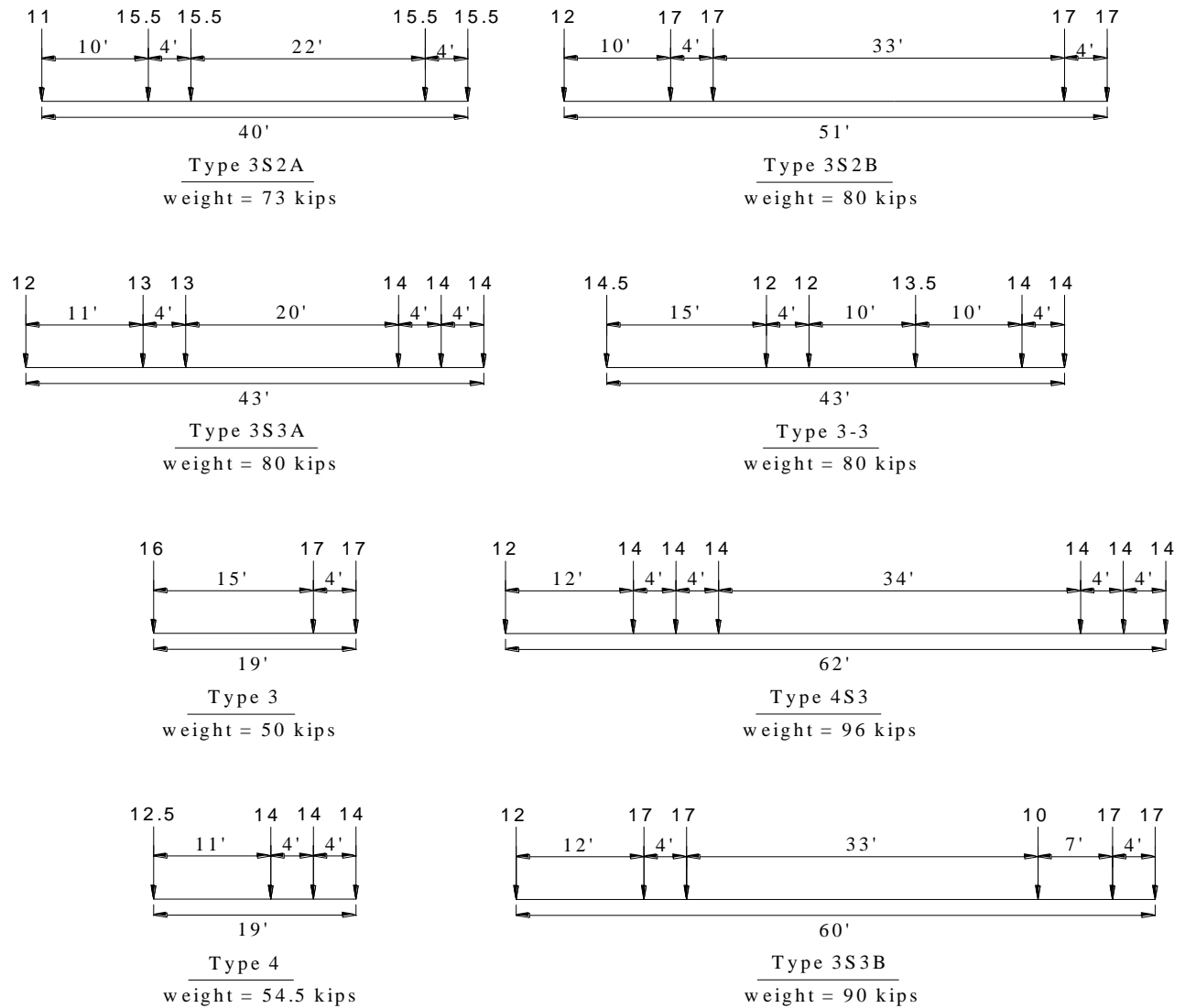
<b>Factor</b>	<b>Inventory</b>	<b>Operating</b>
Dead Load	1.3	1.3
Live Load	2.17	1.3
Impact Load	1.3	1.3

All structural dead loads were applied automatically by the modeling program's self-weight function. Strength capacities were calculated according to the AASHTO Manual for Bridge Evaluation (2013) guidelines and the final calibrated finite-element model provided the structural responses due to the rating and legal trucks. A concrete compressive strength of 3 ksi and a steel reinforcing yield strength of 33 ksi were utilized based on the structure's age.

A library of the rating and Iowa legal loads was generated in WinGEN allowing these vehicles to be evaluated on the calibrated analytical model. Figures 21 and 22 illustrate the rating vehicle configurations used for the Johnson County Bridge. Given the 28 ft wide roadway, both one lane and two lane loaded conditions were considered.



**Figure 21. AASHTO load rating vehicle configurations for Johnson County Bridge**



**Figure 22. Iowa load rating vehicle configurations for Johnson County Bridge**

Using WinSAC, all of the rating and Iowa legal loads were applied individually to the structure as outlined in the specifications. Rating factors were then output for each vehicle and are presented in Table 2.

**Table 2. Johnson County Bridge critical rating factors**

Rating Vehicle	Location/ Limiting Capacity	Inventory Rating Factor		Operating Rating Factor	
		Two Lane	One Lane	Two Lane	One Lane
HS-20(14)	Midspan Flexure	1.44	2.03	2.40	3.39
HS-20(22)	Midspan Flexure	1.48	2.06	2.48	3.45
HS-20(30)	Midspan Flexure	1.48	2.06	2.48	3.44
Type 4	Midspan Flexure	1.76	2.74	2.94	4.58
Type 3S3A	Midspan Flexure	1.77	2.74	2.96	4.58
Type 3-3	Midspan Flexure	2.19	3.34	3.65	5.57
Type 3S3B	Midspan Flexure	1.76	2.67	2.94	4.46
Type 4S3	Midspan Flexure	1.76	2.75	2.94	4.60
Type 3	Midspan Flexure	1.85	2.83	3.09	4.72
Type 3S2B	Midspan Flexure	1.82	2.77	3.04	4.63
Type 3S2A	Midspan Flexure	2.00	3.04	3.34	5.08
Lane Load 1	Midspan Flexure	5.54	8.86	9.25	14.78

The bridge met operational rating criteria ( $RF > 1.0$ ) for all standard design and posting loads for both one and two lanes loaded, as shown in Table 2. Likewise, the inventory rating criteria ( $RF > 1.0$ ) was satisfied for all vehicles for both one and two lanes loaded. The critical rating factor for all vehicles was controlled by the flexural capacity of the slab section near midspan of the bridge.

**SUMMARY AND CONCLUSIONS**

Overall, the live load response data recorded during the field testing of the Johnson County Bridge revealed no abnormalities. The test data exhibited response magnitudes and shapes typical of a skewed slab bridge.

Following testing of the structure, a two-dimensional finite element model of the structure was created using the collected structural information, and subsequently calibrated until an acceptable match between the measured and analytical responses was achieved. A very good correlation between the measured and computed response was obtained during the modeling process. The calibrated model was then utilized to conduct load ratings for the bridge by applying the AASHTO rating vehicle and Iowa legal loads to the model. Comparison of the input member capacities with the model-generated moments resulted in output rating factors for all vehicles.

The load rating results were controlled by the ultimate flexural capacity of the slab section near midspan of the bridge. The results indicated that the bridge had satisfactory operating and inventory level ratings ( $RF > 1.0$ ) for all standard AASHTO design and rating loads for both one and two lanes loaded.

## REFERENCES

AASHTO (1996). *AASHTO Standard Specifications*. Washington, DC.

AASHTO (2013). *Manual for the Bridge Evaluation*, Second Edition – 2013 Revisions. Washington, DC.